

HAWORTH

Prices in this book increased on July 1 and December 1, 2021; and May 1 and October 1, 2022 by various amounts. Please contact your Haworth dealer for updated pricing. More details are on inside front cover.

Seating

North America Price List – February 2021



Electronic Update Page – Seating Price List

- The table below lists all of the updates and addendums added to this price list since the original version was created.
- All **Update** pages will replace the existing pages within the document.
- All **New** pages will be placed at the back of the document.

Link	Date	Page	Description
Click Here	March 2021	154-157	Update – Seat depth corrected for Improv Series seating.
Click Here	March 2021	254	Update – Mesh offering was corrected for Fern seating.
Click Here	March 2021	237	Update – Updated COM / COL requirements for Poppy Sled Base.
Click Here	July 2021	All Price List Pages	Update – Effective July 1, 2021, prices in the Seating Price Book will increase by: 4%– Fern, Zody, Very, Soji, Improv, X99, Maari, Riverbend, Openest and Poppy. 0% – All other products
Click Here	August 2021	1A-4A	New – New Price List pages added for Veda seating.
Click Here	September 2021	3A-4A	Update – Bullet added to Features about assembly.
Click Here	September 2021	155	Update – Improv H.E. XL Chair with Height Adjustable Task Arms has been obsoleted.
Click Here	October 2021	1A-4A	Update – Updated GSA information on the footer.
Click Here	October 2021	Warranty Page	Update – Warranty Page Updated.
Click Here	December 2021	Price List Pages	Update – Prices in this book increased on July 1, 2021 and will increase again December 1, 2021. See front cover for percentages
Click Here	February 2022	236	Update – Tablet arm added to the Five Star Base with casters.
Click Here	March 2022	244-246	Update – Hello Seating products have been obsoleted.
Click Here	March 2022	189-190, 198-199	Update – Correction made to Maari Five Star Base Price List Pages and General Specification Pages (Pricing now reflects current April 2022 Haworth pricing).
Click Here	May 2022	All Price List Pages	Update – Prices in this book increased on July 1, 2021, and December 1, 2021 and will increase again May 1, 2022. See front cover for percentages.
Click Here	May 2022	22, 46, 87	Update – Price List pages removed.
Click Here	May 2022	204-205	Update – Additional specification for the foot ring added.
Click Here	Aug 2022	5A-30A	New – Price List pages added for Zody II and Zody LX seating.
Click Here	August 2022	Warranty Page	Update – Warranty Page Updated.
Click Here	September 2022	48, 49, 52, 53, 56, 57, 60, 61, 64, 65, 68, 69, 72, 73, 76, 77, 158-167, 169, 210, 244, 246, 247, 250-252	Update – Various products or product configurations have been discontinued, effective September 2022.
Click Here	October 2022	All Price List Pages	Update – Prices in this book increased on July 1, 2021, December 1, 2021, May 1, 2022 and October 1, 2022 by various amounts. Please contact your Haworth dealer for updated pricing. See the chart below for additional details.
Click Here	November 2022	126	Update – SCT-3 and SCT-4 updated to reflect stacking up to 6-high.
Click Here	November 2022	205	Update – Maari Low Back Stool without upholstered seat pad was obsoleted.
Click Here	November 2022	254-256	Update – Various finish updates.
Click Here	November 2022	12A, 15A, 17A, 25A, 27A, 29A	Update – A clarification for Zody II and Zody LX arm cap options was added.

Effective on the dates listed below, prices for these products will increase by the following percentages:

Product	July 1, 2021 Increase	Dec 1, 2021 Increase	May 1, 2022 Increase	October 1, 2022 Increase
Fern*	4%	4%	8.7%*	9%
Zody*	4%	4%	10.9%*	9%
Very*	4%	4%	9%*	9%
Soji	4%	4%	8%	9%
Improv	4%	4%	8%	9%
X99	4%	4%	8%	9%
Maari*	4%	4%	9.5%*	9%
Riverbend	4%	4%	8%	9%
Openest	4%	4%	8%	9%
Poppy*	4%	4%	12.5%*	9%
Improv Side	0%	4%	8%	9%
Improv Task	0%	10%	8%	9%
Other Task	0%	10%	8%	9%
Other Guest	0%	10%	8%	9%
Other Lounge	0%	8%	8%	9%
Veda	0%	0%	21%	0%

To calculate the **current list price** for each product, the **printed list price** must be increased using each percentage compounded in sequential order.

* The following product lines have surgical changes that may differ from the overall weighted increase, depending on the product options, sizes or material ordered.



This Haworth North American price book contains US list prices.

Canadian customers can convert the US list price into their Canadian equivalent by going to www.Haworth.com/Canada to find the current Canadian multipliers. These multiplier factors allow you to convert the US list price into a Canadian list price.

Price Book Overview

The following overview explains how information is organized within the Seating price book (Includes: Fern®, Zody®, Very®, Soji®, Improv®, X99®, Maari®, Candor®, Composites™, Forenze™, Riverbend™, Pebble®, Openest™, Pip™, Poppy™, HarborWork Lounge®, Hello®, ToDo® and Tilt™).

- 1 Front Cover**
 - Includes the price book title and pricing effectivity date.
- 2 Canadian Conversion / Update Page**
 - Pricing conversion information for converting US pricing into the equivalent Canadian pricing is located on the footer of this page.
 - All Price Book updates will be listed on this page including the date, page number and description of the update.
- 3 Price List Table of Contents**
 - Price List table of contents with page numbers.
- 4 Statement of Line**
 - Provides a pictorial outline of the entire product offering.
- 5 Price List**

Each price list page contains the following:

 - Product Illustration
 - Catalog Number
 - To Order Specify – sequencing for ordering product options and finishes
 - List Prices
 - Product Specification Dimensions
 - Features
 - Specification Tips
 - Class, Discount Group Number (used for discounting) and GSA information
- 6 Finishes, Fabrics and COM**
 - Lists information for material finishes and availability.
 - Provides COM information and requirements (if applicable).
- 7 North American Terms of Sale**
 - Haworth terms for ordering, pricing, shipping and delivery, general terms, and services.
- 8 Index**
 - Products are listed alphabetically by alpha-numeric catalog numbers with price list page number.
- 9 Product Non-Obsolescence and Warranty Policy**
 - Provides information about the Haworth policy for non-obsolescence and warranty.

Additional Information and Resources

Prices are subject to change without notice or approval. Haworth dealers should always submit proposals through Lynx before presenting to customers. See North American Terms of Sale for more information.

Online Resources

haworth.com

- Haworth's corporate website provides access to price books and a variety of other resources and publications.

surfaces.haworth.com

- Website provides access to the most current fabrics and finishes offered across Haworth's various product lines.

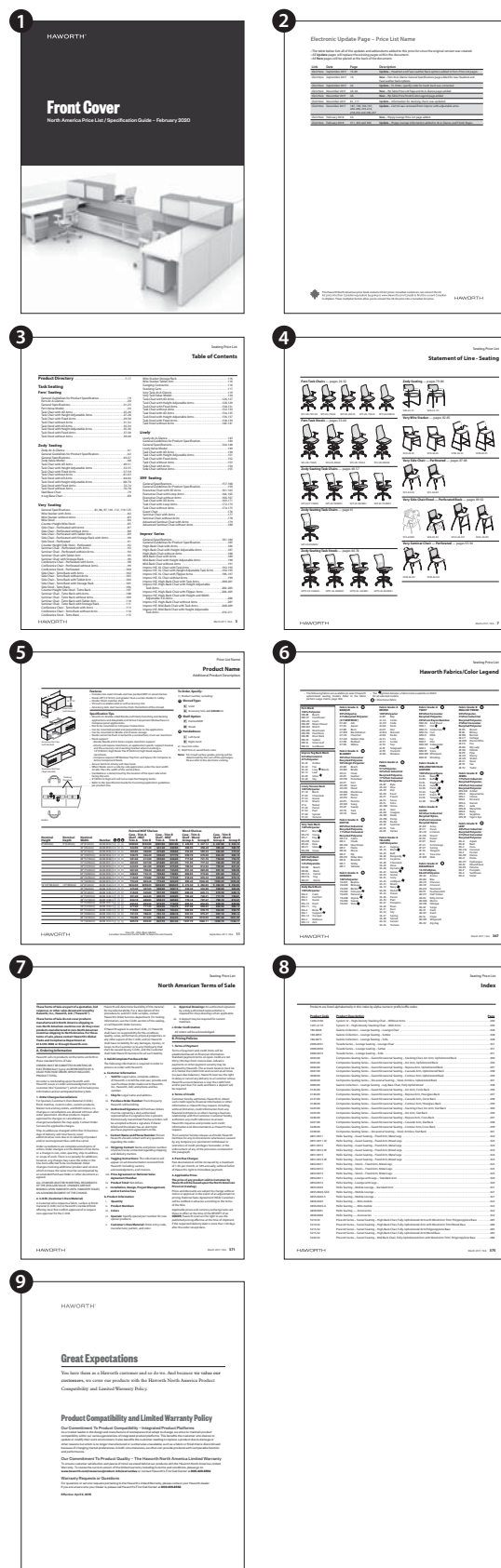

Table of Contents

Statement of Line 6-15

Task Seating

Fern® Seating

General Guidelines for Product Specification	17
Fern At-A-Glance — General Specifications	18
General Specifications	19-21
Task Chair with 4D Arms — Plastic Base Model	22-23
Task Chair with 4D Arms — Aluminum Base Model	24
Task Chair with Height Adjustable Arms — Plastic Base Model	25
Task Chair with Height Adjustable Arms — Aluminum Base Model	26
Task Chair with Fixed Arms — Plastic Base Model	27
Task Chair with Fixed Arms — Aluminum Base Model	28
Task Chair without Arms — Plastic Base Model	29
Task Chair without Arms — Aluminum Base Model	30
Task Stool with 4D Arms — Plastic Base Model	31
Task Stool with 4D Arms — Aluminum Base Model	32
Task Stool with Height Adjustable Arms — Plastic Base Model	33
Task Stool with Height Adjustable Arms — Aluminum Base Model	34
Task Stool with Fixed Arms — Plastic Base Model	35
Task Stool with Fixed Arms — Aluminum Base Model	36
Task Stool without Arms — Plastic Base Model	37
Task Stool without Arms — Aluminum Base Model	38

Zody® Seating

Zody-At-A-Glance	39
General Guidelines for Product Specification	40-41
General Specifications	42-45
Task Chair with 4D Arms	46-49
Task Chair with Height Adjustable Arms	51-53
Task Chair with Fixed Arms	55-57
Task Chair without Arms	59-61
Task Stool with 4D Arms	63-65
Task Stool with Height Adjustable Arms	67-69
Task Stool with Fixed Arms	71-73
Task Stool without Arms	75-77
Sled Base	78
4 Leg	79

Very® Seating

Very-Task-At-A Glance	81
General Specifications	82-86
Task Chair with 4D Arms	87-89
Task Chair with Height Adjustable Arms	90-91
Task Chair with Fixed Arms	92-93
Task Chair without Arms	94-95
Task Stool with 4D Arms	96-97
Task Stool with Height Adjustable Arms	98-99
Task Stool with Fixed Arms	100-101
Task Stool without Arms	102-103
General Specifications	105
Wire Stacker with Arms	106
Wire Stacker without Arms	107
Bar Height Wire Stool	108
Counter Height Wire Stool	109
General Specifications	110
Side Chair - Perforated Back with Arms	111
Side Chair - Perforated Back without Arms	112
Side Chair - Perforated Back with Tablet Arm	113
Side Chair - Perforated Back with Storage Rack	114
Bar Height Side Stool - Perforated Back	115
Counter Height Side Stool - Perforated Back	116
Seminar Chair - Perforated Back with Arms	117
Seminar Chair - Perforated Back without Arms	118

Seminar Chair - Perforated Back with Tablet Arm	119
Seminar Chair - Perforated Back with Storage Rack	120
General Specifications	121
Conference Chair - Perforated Back with Arms	122
Conference Chair - Perforated Back without Arms	123
Conference Stool - Perforated Back	124
Wire Stacker Storage Rack	125
Wire Stacker Tablet Arm	125
Ganging Connector	125
Stacking Carts	126

Soji® Seating

General Guidelines for Product Specification	127
Soji At-A-Glance — General Specifications	128
General Specifications	129-132
Task Chair with 4D Arms — Plastic Base	133
Task Chair with 4D Arms — Aluminum Base	134
Task Chair with Height Adjustable Arms — Plastic Base	135
Task Chair with Height Adjustable Arms — Aluminum Base	136
Task Chair with Fixed Arms — Plastic Base	137
Task Chair with Fixed Arms — Aluminum Base	138
Task Chair without Arms — Plastic Base	139
Task Chair without Arms — Aluminum Base	140
Task Stool with 4D Arms — Plastic Base	141
Task Stool with 4D Arms — Aluminum Base	142
Task Stool with Height Adjustable Arms — Plastic Base	143
Task Stool with Height Adjustable Arms — Aluminum Base	144
Task Stool with Fixed Arms — Plastic Base	145
Task Stool with Fixed Arms — Aluminum Base	146
Task Stool without Arms — Plastic Base	147
Task Stool without Arms — Aluminum Base	148

Improv® Series

General Specifications	149-152
General Guidelines for Product Specification	153
Improv H.E. XL Chair with Task Arms	154
Improv H.E. XL Chair with Height Adjustable Task Arms	155
Improv H.E. XL Chair with Flipper Arms	156
Improv H.E. XL Chair without Arms	157
Improv H.E. High-Back Chair with Task Arms	158
Improv H.E. High-Back Chair with Height Adjustable Task Arms	159
Improv H.E. High-Back Chair with Flipper Arms	160
Improv H.E. High-Back Chair with Height and Width Adjustable 3-D Arms	161
Improv H.E. High-Back Chair without Arms	162
Improv H.E. Mid-Back Chair with Task Arms	163
Improv H.E. Mid-Back Chair with Height Adjustable Task Arms	164
Improv H.E. Mid-Back Chair with Flipper Arms	165
Improv H.E. Mid-Back Chair with Height and Width Adjustable 3-D Arms	166
Improv H.E. Mid-Back Chair without Arms	167
Improv H.E. Stool with Task Arms	168
Improv H.E. Stool with Height Adjustable Task Arms	169
Improv H.E. Stool with Flipper Arms	170
Improv H.E. Stool with Height and Width Adjustable 3-D Arms	171
Improv H.E. Stool without Arms	172
Leg-Base Stacking Chair with Arms	173
Leg-Base Stacking Chair without Arms	174
Sled-Base Chair with Arms	175
Sled-Base Chair without Arms	176
Stool with Arms	177
Stool without Arms	177
Stacking Dolly	178
Chair-to-Chair Connecting Bars	178
Tandem Seating and Tables Specifications	179
Tandem Seating and Tables Dimensions	179

Table of Contents

X99® Seating

General Specifications	181
General Guidelines for Product Specification	182
Guest Chair	183
Seminar Chair with Arms	184
Seminar Chair without Arms	185
Advanced Seminar Chair with Arms	186
Advanced Seminar Chair without Arms	187

Maari® Seating

General Specifications	189-190
Sled Base Chair With Arms	191
Sled Base Chair Without Arms	192
Four-Leg Chair With Arms	193
Four-Leg Chair Without Arms	194
Wood-Leg Chair Without Arms	195
Four-Star Base Chair With Arms	196
Four-Star Base Chair Without Arms	197
Five-Star Base Chair With Arms	198
Five-Star Base Chair Without Arms	199
Sled Base Stool Standard Back	200
Sled Base Stool Low Back	201
Four-Leg Stool With Arms	202
Four-Leg Stool Without Arms	203
Wood-Leg Stool Standard Back	204
Wood-Leg Stool Low Back	205

Wood Side Seating

General Specifications	207
General Guidelines for Product Specification	207

Candor® Seating

Modern Fully Upholstered Seat and Back	208
Modern Fully Upholstered Seat and 1/2 Back	208

Composites™ Seating Series

Arc Arm, Upholstered Back	209
Stool, Armless, Upholstered Back	209

Forenze™ Seating

Cabriole Arm, Slat Back	210
Cabriole Arm, Upholstered Back	210

Lounge Seating

Riverbend™ and Pebble®

Riverbend and Pebble -At-A-Glance	211-216
-----------------------------------	---------

Riverbend™

Single Seat – Straight	217
Double Seat – Straight	218
Triple Seat – Straight	219
90° Curved – Concave	220
60° Curved – Concave	221
60° Curved – Convex	222
Corner – Square	223

Pebble®

Ottoman	224
---------	-----

Riverbend Accessories

Ganging Bracket	225
-----------------	-----

Riverbend Power Module

Corded	226
Hardwire	226

Openest™ Collection

Plume 3	227
Plume 6	227
Plume 9	227
Feather – Symmetrical	228
Feather – Asymmetrical	228
Chick Pouf with Back	229
Chick Pouf without Back	229
Large Square – No Back	230
Rectangle – No Back	230
Round – No Back	231
Sprig Table – Rectangle	232
Sprig Table – Round	232

Pip™

Personal Laptop Table	233
-----------------------	-----

Poppy™

Poppy-At-A-Glance	235
Four Star Base with Glides	236
Five Star Base with Casters	236
Sled Base	237
Wood Base	237
Basket	238
Swivel	238

Harbor Work Lounge®

Harbor Work Lounge-At-A-Glance	239
Fully Upholstered, Cast Aluminum Base Lounge Chair	240
Fully Upholstered, Cast Aluminum Base Ottoman	241
Partially Upholstered, Cast Aluminum Base Lounge Chair	242
Partially Upholstered, Cast Aluminum Base Ottoman	243

Hello® Seating

Lounge with Legs, Standard Arm	244
Mobile Lounge, Standard Arm	245
Tablet Arm	246
Cup Holder	246
Mini-mobile	246
Guest Seating Fixed Arms, Wood Legs	247

ToDo®

General Specifications	248-249
Single, Stationary	250
Single, Mobile	251
Wood Tablet with Arm	252
Cup Holder	252
Grommet Cover	252

Tilt™

Tilt Stool	253
------------	-----

Finishes and Fabrics

Finish/Color Legends	254-257
Fabric Pattern Usage Matrix	258
Haworth Fabrics/Color Legend	259
COM Information	260

Terms of Sale

North America	261-264
---------------	---------

Index

Index	265-270
-------	---------

Product Warranty

Inside Back Cover

Statement of Line

Fern Task Chair — pages 22-30



SFT-U0-7501A5
4D Arms
Plastic Base



SFT-U0-7501A
4D Arms
Plastic Base



SFT-U0-7501A
4D Arms
Aluminum Base



SFT-U0-4501A
Height
Adjustable Arms
Plastic Base



SFT-U0-4501A
Height
Adjustable Arms
Aluminum Base



SFT-U0-1501A
Fixed Arms
Plastic Base



SFT-U0-1501A
Fixed Arms
Aluminum Base



SFT-U0-0N01A
Without Arms
Plastic Base



SFT-U0-0N01A
Without Arms
Aluminum Base

Fern Task Stool — pages 31-38



SFS-U0-7501A
4D Arms
Plastic Base



SFS-U0-7501A
4D Arms
Aluminum Base



SFS-U0-4501A
Height
Adjustable Arms
Plastic Base



SFS-U0-4501A
Height
Adjustable Arms
Aluminum Base



SFS-U0-1501A
Fixed Arms
Plastic Base



SFS-U0-1501A
Fixed Arms
Aluminum Base



SFS-U0-0N01A
Without Arms
Plastic Base



SFS-U0-0N01A
Without Arms
Aluminum Base

Zody Task Chair/Stool — pages 46-77



SZA-20-711MAS
4D Arms



SZA-20-702MA1
4D Arms



SZA-20-402MA1
Height
Adjustable Arms



SZA-20-102MA1
Fixed Arms



SZA-20-002MA1
Without Arms



SZTC-20-702MA1
4D Arms



SZTC-20-402MA1
Height
Adjustable Arms



SZTC-20-102MA1
Fixed Arms



SZTC-20-002MA1
Without Arms

Zody Guest — pages 78-79



SZG-22-1
Sled Base



SZG-22-1
4 Leg

Very Task Chair/Stool — pages 86-103



SCT-20-7115
4D Arms



SCT-20-7011
4D Arms



SCT-20-4011
Height
Adjustable Arms



SCT-20-1011
Fixed Arms



SCT-20-0011
Without Arms



SZTC-20-7011
4D Arms



SZTC-20-4011
Height
Adjustable Arms



SZTC-20-1011
Fixed Arms



SZTC-20-0011
Without Arms

Statement of Line

Very Wire Stacker Chair/Stool — pages 106-109

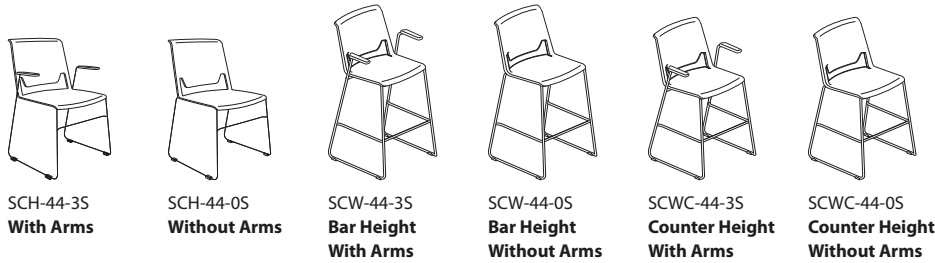

Very Side Chair/Stool — Perforated Back — pages 111-116

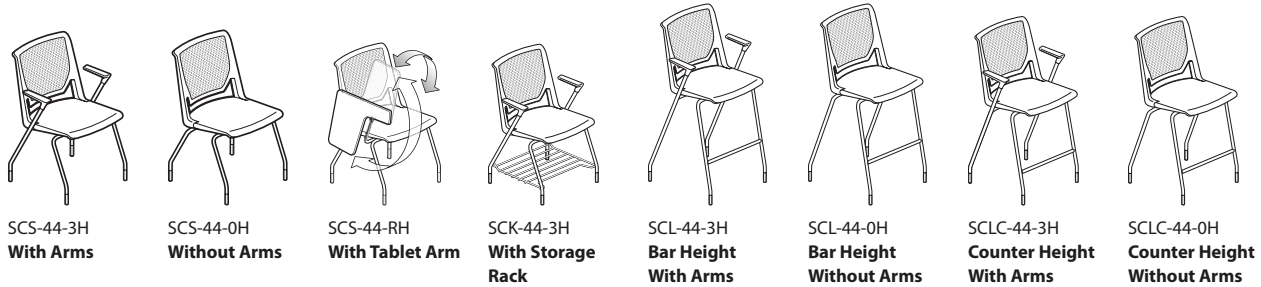

Very Seminar Chair — Perforated Back — pages 117-120



Very Conference Chair/Stool — Perforated Back — pages 122-124



Very Accessories — pages 125-126

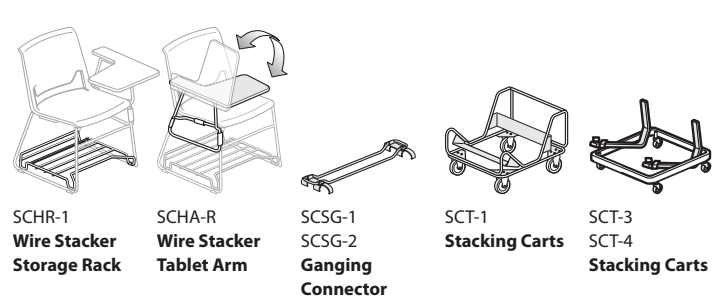

Soji Task Chair — pages 133-140

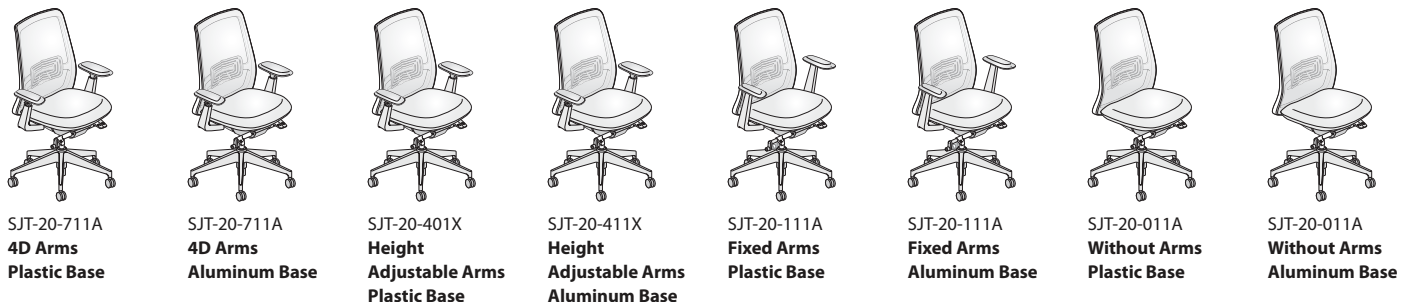

Statement of Line

Soji Task Stool — pages 141-148



SJTC-701X
SJTC-701A
4D Arms
Plastic Base



SJTC-701X
SJTC-701A
4D Arms
Aluminum Base



SJTC-401X
SJTC-401A
Height Adjustable Arms
Plastic Base



SJTC-401X
SJTC-401A
Height Adjustable Arms
Aluminum Base



SJTC-101X
SJTC-101A
Fixed Arms
Plastic Base



SJTC-101X
SJTC-101A
Fixed Arms
Aluminum Base



SJTC-001X
SJTC-001A
Without Arms
Plastic Base



SJTC-001X
SJTC-001A
Without Arms
Aluminum Base

Improv Series H.E. XL Chairs — pages 154-157



M271-1442
Task Arms



M271-1742
Height Adjustable Task Arms



M271-1H42
Flipper Arms



M271-1042
Without Arms

Improv Series H.E. High-Back Chairs — pages 158-162



M251-1442
Task Arms



M251-1742
Height Adjustable Task Arms



M251-1H42
Flipper Arms



M251-1W42
Height and Width Adjustable 3-D Arms



M251-1042
Without Arms

Improv Series H.E. Mid-Back Chairs — pages 163-167



M231-1442
Task Arms



M231-1742
Height Adjustable Task Arms



M231-1H42
Flipper Arms



M231-1W42
Height and Width Adjustable 3-D Arms



M231-1042
Without Arms

Improv Series H.E. Stools — pages 168-172



M2E1-1442
Task Arms



M2E1-1742
Height Adjustable Task Arms



M2E1-1H42
Flipper Arms



M2E1-1W42
Height and Width Adjustable 3-D Arms



M2E1-1042
Without Arms

Statement of Line

Improv Series Leg-Base Stacking Chairs — pages 173-174



M600-2110
With Arms



M600-2310
With Arms
Wood Back



M600-2100
Without Arms



M600-2300
Without Arms
Wood Back

Improv Series Sled-Base Non-Stacking Chairs — pages 175-176

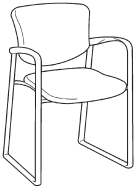

M601-2110
With Arms

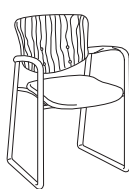

M601-2310
With Arms
Wood Back

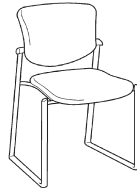

M601-2100
Without Arms

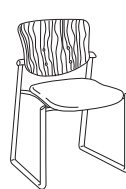

M601-2300
Without Arms
Wood Back

Improv Series Stools — page 177



M600-8110
With Arms



M600-8310
With Arms
Wood Back



M600-8100
Without Arms



M600-8300
Without Arms
Wood Back

Improv Series Accessories — page 178

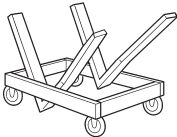

MPRV-CART
Stacking Dolly

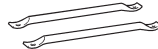

MPRV-BARS
Chair-to-Chair
Connecting Bars

X99 Guest & Seminar Chairs — pages 183-187



X630-3100
Guest Chair
With Arms



X640-0140
Seminar Chair
With Arms



X640-0040
Seminar Chair
Without Arms



X641-2140
Advanced
Seminar Chair
With Arms



X641-2040
Advanced
Seminar Chair
Without Arms

Statement of Line

Maari Sled Base Chair — pages 191-192



S7H-44-1H
With Arms
Without Optional
Upholstered Pad



S7H-24-1H
With Arms
With Upholstered
Seat Pad



S7H-22-1H
With Arms
With Upholstered
Seat and Back Pad



S7H-44-0H
Without Arms
Without Optional
Upholstered Pad



S7H-24-0H
Without Arms
With Upholstered
Seat Pad



S7H-22-0H
Without Arms
With Upholstered
Seat and Back Pad

Maari Four-Leg Chair — pages 193-194



S7S-44-11
With Arms
Without Optional
Upholstered Pad



S7S-24-11
With Arms
With Upholstered
Seat Pad



S7S-22-11
With Arms
With Upholstered
Seat and Back Pad



S7S-44-0H
Without Arms
Without Optional
Upholstered Pad



S7S-24-0H
Without Arms
With Upholstered
Seat Pad



S7S-22-0H
Without Arms
With Upholstered
Seat and Back Pad

Maari Wood-Leg Chair — page 195



S7W-44-0H
Without Arms
Without Optional
Upholstered Pad



S7W-24-0H
Without Arms
With Upholstered
Seat Pad



S7W-22-0H
Without Arms
With Upholstered
Seat and Back Pad

Maari Four-Star Base Chair — pages 196-197



S74-44-1H
With Arms
Without Optional
Upholstered Pad



S74-24-1H
With Arms
With Upholstered
Seat Pad



S74-22-1H
With Arms
With Upholstered
Seat and Back Pad



S74-44-0H
Without Arms
Without Optional
Upholstered Pad



S74-24-0H
Without Arms
With Upholstered
Seat Pad



S74-22-0H
Without Arms
With Upholstered
Seat and Back Pad

Maari Five-Star Base Chair — pages 198-199



S75-44-11
With Arms
Without Optional
Upholstered Pad



S75-24-11
With Arms
With Upholstered
Seat Pad



S75-22-11
With Arms
With Upholstered
Seat and Back Pad



S75-44-01
Without Arms
Without Optional
Upholstered Pad



S75-24-01
Without Arms
With Upholstered
Seat Pad



S75-22-01
Without Arms
With Upholstered
Seat and Back Pad

Statement of Line

Maari Sled Base Stool — page 200-201



S7HB-44-0H
S7HC-44-0H
Standard Back
Without Optional
Upholstered Pad



S7HB-24-0H
S7HC-24-0H
Standard Back
With Upholstered
Seat Pad



S7HB-22-0H
S7HC-22-0H
Standard Back
With Upholstered
Seat and Back Pad



S8HB-24-0H
S8HC-24-0H
Low Back
With Upholstered
Seat Pad

Maari Four-Leg Stool — pages 202-203



S7SB-44-1H
S7SC-44-1H
With Arms
Without Optional
Upholstered Pad



S7SB-24-1H
S7SC-24-1H
With Arms
With Upholstered
Seat Pad



S7SB-22-1H
S7SC-22-1H
With Arms
With Upholstered
Seat and Back Pad



S7SB-44-0H
S7SC-44-0H
Without Arms
Without Optional
Upholstered Pad



S7SB-24-0H
S7SC-24-0H
Without Arms
With Upholstered
Seat Pad



S7SB-22-0H
S7SC-22-0H
Without Arms
With Upholstered
Seat and Back Pad

Maari Wood-Leg Stool — page 204-205



S7WB-44-0H
S7WC-44-0H
Standard Back
Without Optional
Upholstered Pad



S7WB-24-0H
S7WC-24-0H
Standard Back
With Upholstered
Seat Pad



S7WB-22-0H
S7WC-22-0H
Standard Back
With Upholstered
Seat and Back Pad



S8WB-24-0H
S8WC-24-0H
Low Back
With Upholstered
Seat Pad

Candor Modern Seating — page 208



SAS-22-A1A
Fully Upholstered
Seat and Back



SAS-22-A3A
Fully Upholstered
Seat and 1/2 Back

Composites Chair/Stool — page 209



4045-00
Arc Arm,
Upholstered Back

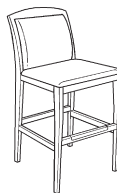

4049-00
Stool, Armless,
Upholstered Back

Statement of Line

Forenze Cabriole Arm Models — page 210



8484-00
Slat Back



8184-00
Upholstered Back

Riverbend Straight — pages 217- 219

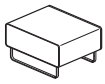

SMSN-2028-H
Single Seat
No Back

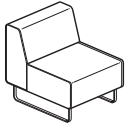

SMSM-2228-H
Single Seat
Mid-Back

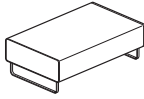

SMSN-2055-H
Double Seat
No Back

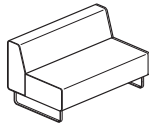

SMSM-2255-H
Double Seat
Mid-Back

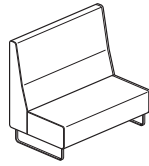

SMSH-2255-H
Double Seat
High-Back

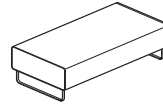

SMSN-2067-H
Triple Seat
No Back

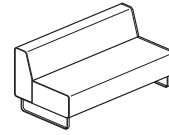

SMSM-2267-H
Triple Seat
Mid-Back

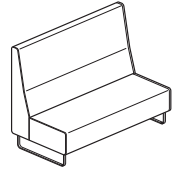

SMSH-2267-H
Triple Seat
High-Back

Riverbend Curved – 90° Concave — page 220

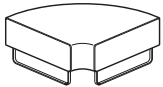

SMCN-2056-HS
No Back

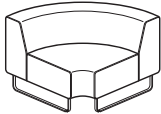

SMCM-2256-HS
Mid-Back

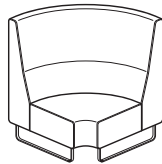

SMCH-2256-HS
High-Back

Riverbend Curved – 60° Concave — page 221



SMCN-2058-HS
No Back

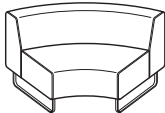

SMCM-2258-HS
Mid-Back

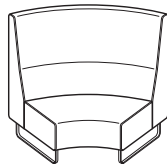

SMCH-2258-HS
High-Back

Riverbend Curved – 60° Convex — page 222



SMVM-2258-HS
Mid-Back

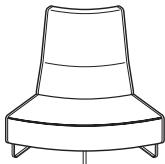

SMVH-2258-HS
High-Back

Riverbend Corner – Square — page 223

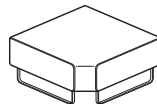

SMQN-2040-H
No Back

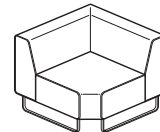

SMQM-2040-H
Mid-Back

Pebble – Ottoman — page 224



STSN-2025-HN
Square - Small

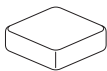

STSN-2033-HN
Square - Medium

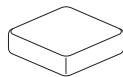

STSN-2047-HN
Square - Large

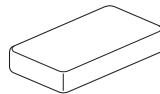

STSN-2067-HN
Rectangle

Statement of Line

Riverbend Accessories – Ganging Bracket— page 225

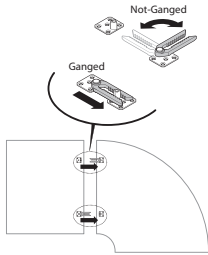

SMG-1

Riverbend Power Module — page 226

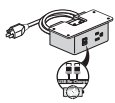

EUSM-PFOW-1100
EUSM-PLOW-1100
Corded

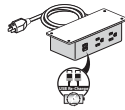

EUSM-PFOW-2100
EUSM-PLOW-2100
Corded

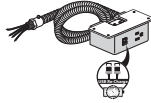

EUSM-HFOW-1100
EUSM-HLOW-1100
Hardwire

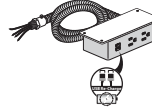

EUSM-HFOW-2100
EUSM-HLOW-2100
Hardwire

Openst Collection Plume Screens — page 227

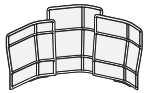

SON-3
Plume 3

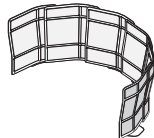

SON-6
Plume 6

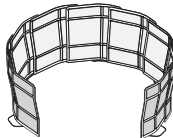

SON-9
Plume 9

Openst Collection Feather Sofa — page 228

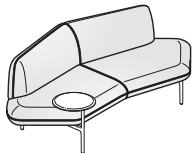

SOSS-1-RW
Symmetrical

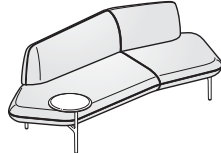

SOSR-1-RW
Asymmetrical

Openst Collection Chick Pouf — pages 229-231



SOPB-2223
Chick Pouf with Back



SOPN-2223
Chick Pouf without Back



SOPN-2238
Large Square - No Back

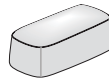

SOPN-2252
Rectangle - No Back



SOPN-2265
Round - No Back

Openst Collection Sprig Tables — page 232

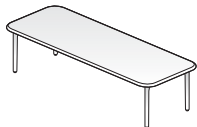

SORA-5320-P
Rectangle



SODC-1616-P
Round - 16"



SODB-2424-P
Round - 24"

Statement of Line

Pip — page 233



STP-P26-TH
Personal Laptop Table

Poppy Guest — pages 236-237



SPG-11-4
Four Star Base
with Glides



SPG-11-5
Five Star Base
with Casters



SPG-11-7
Sled Base



SPG-11-W
Wood Base

Poppy Lounge — page 238

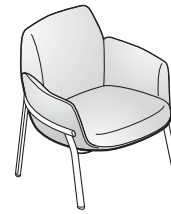

SLP-22-T
Basket



SLP-22-S
SLP-22-R
Swivel

Harbor Work Lounge — pages 240-243



SHL-22-1R10
Fully Upholstered
Lounge Chair
With Wing



SHL-22-1R12
Fully Upholstered
Lounge Chair
With Wing and Tablet



SHO-22-G
Fully Upholstered
Ottoman



SHL-25-1L10
Partially Upholstered
Lounge Chair
With Wing



SHL-25-1L12
Partially Upholstered
Lounge Chair
With Wing and Tablet



SHO-25-G
Partially Upholstered
Ottoman

Hello Lounge Seating with Legs — page 244

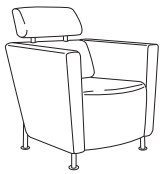

4854-0011
Standard Arm

Hello Mobile Lounge Seating — page 245



4855-0043
Standard Arm

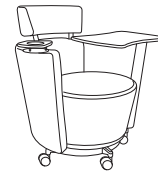

4855-0043-GX
Tablet Arm and Cup Holder

Hello Seating Accessories — page 246



4858-0001
Tablet Arm



4858-0002
Cup Holder

Hello Seating Mini-mobile — page 246



4856-0043
Armless

Statement of Line

Hello Guest Seating — page 247



4851-0011-W
Fixed Arm, Wood Legs

ToDo Stationary & Mobile Seating — pages 250-251

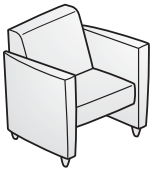

TQ84-0011
Single, Stationary

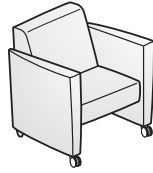

TQ85-0011
Single, Mobile

ToDo Accessories — page 252

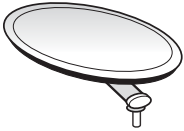

TQ90-0001
Wood Tablet with Arm



TQ90-0003
Cup Holder



TQ90-0006
Grommet Cover

Tilt Stool — page 253

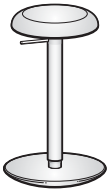

STS-1
Stool

This page intentionally blank

Fern

General Specifications

General Guidelines for Product Specification

	S	F	T - U	0 - 1	S	1	4	A	T	3A-18	MB-BE	TR-F	TR-TF
Product Type	_____	_____	_____	_____	_____	_____	_____	_____	_____	_____	_____	_____	_____
(S) Seating													
Product Line	_____	_____	_____	_____	_____	_____	_____	_____	_____	_____	_____	_____	_____
(F) Fern													
Model (Product Type)	_____	_____	_____	_____	_____	_____	_____	_____	_____	_____	_____	_____	_____
(T) Task													
(S) Stool													
(E) Executive													
Seat (UPH)	_____	_____	_____	_____	_____	_____	_____	_____	_____	_____	_____	_____	_____
(U) Upholstery													
Back Upholstery	_____	_____	_____	_____	_____	_____	_____	_____	_____	_____	_____	_____	_____
(0) Mesh													
(U) Knit/Upholstery													
Arms	_____	_____	_____	_____	_____	_____	_____	_____	_____	_____	_____	_____	_____
(0) No Arms													
(1) Fixed Arms													
(4) Height Adjustable													
(7) 4D Arms													
Arm Cap	_____	_____	_____	_____	_____	_____	_____	_____	_____	_____	_____	_____	_____
(S) Soft Cap													
(N) No Cap													
(L) Leather Cap (fixed arms only)													
Lumbar	_____	_____	_____	_____	_____	_____	_____	_____	_____	_____	_____	_____	_____
(0) No Lumbar													
(1) Lumbar													
Control	_____	_____	_____	_____	_____	_____	_____	_____	_____	_____	_____	_____	_____
(1) Pneumatic w/Back Stop													
(4) Pneumatic/Back Stop & Forward Tilt													
Seat Adjustment	_____	_____	_____	_____	_____	_____	_____	_____	_____	_____	_____	_____	_____
(A) Adjustable													
(F) Fixed													
Base & Caster Combo	_____	_____	_____	_____	_____	_____	_____	_____	_____	_____	_____	_____	_____
(1) Aluminum Hard Casters													
(2) Aluminum Soft Casters													
(T) Aluminum 2 Tone Hard Casters													
(5) Plastic Hard Casters													
(6) Plastic Soft Casters													
(7) Plastic 2 Tone Hard Casters													
(3) Aluminum Low Hard Casters													
(4) Aluminum Low Soft Casters													
Seat Upholstery	_____	_____	_____	_____	_____	_____	_____	_____	_____	_____	_____	_____	_____
Tellure													
Back Mesh	_____	_____	_____	_____	_____	_____	_____	_____	_____	_____	_____	_____	_____
Mesh													
Plastic Trim Color	_____	_____	_____	_____	_____	_____	_____	_____	_____	_____	_____	_____	_____
Plastic Model -													
(spine/wave suspension material/arm caps/levers/base)													
Aluminum Model -													
(spine/wave suspension material/arm caps/levers)													
Aluminum Trim Color	_____	_____	_____	_____	_____	_____	_____	_____	_____	_____	_____	_____	_____
Plastic Model -													
(back and arm upright/mechanism)													
Aluminum Model -													
(back and arm upright/mechanism/base)													

Fern At-A-Glance

General Specifications

Designer	Haworth Design Studio, through collaboration with ITO Design.
Fern	A revolutionary chair, backed by 16 patents and on-going research that blends science-based wellness and comfort with sustainability and international design.
Awards	2016 Best of Year award for Task Seating from Interior Design 2017 Red Dot award: Product Design
Environmental Factors	Refer to Product Environmental Data sheet (PED) for recycled content and certifications. Take Back Program - can be easily disassembled at the end of its useful life. Manufactured in a zero landfill, ISO 14001 certified facility in Bruce, MS, USA.
Finishes and Fabrics	A complete listing of finishes and fabrics for Fern seating is available in the back of the price list.
COM & COL General Information	<p>To order a COM fabric (Customer's Own Material) contact the Haworth Inquiry Center (1.800.462.8562), your local Haworth dealer, or go to Surfaces.haworth.com to find out if the COM you have selected has already been tested and approved. The surface collection site also has information on the Haworth alliance program with Carnegie, Luna Textiles, and Maharam as well as our industry-leading Pre-Approved COM program.</p> <p>COM fabrics are placed into Grades based on the cost per linear yard. If a fabric's cost exceeds the range of our highest Grade it will be noted as Non-Graded. The product will be priced at Grade A; the COM fabric costs will appear as a separate line item. The fabric charge will be Haworth's purchase cost plus a 4% administrative fee (based on the cost of the fabric). Yardage calculations will include any applicable fabric repeat.</p> <p>COM Leather products will be priced at a leather Grade A; COL costs will appear as a separate line item. The leather costs will be Haworth's purchase cost plus a 4% administrative fee (based on the cost of the leather).</p>
Stain Repellent	Stain repellent available on seat only. To specify add "P" to the end of the product number. Example: SFT-U0-7S02A1P
Shipping Weights/Cube (Including packaging)	<ul style="list-style-type: none"> • Task Chair <ul style="list-style-type: none"> -With arms - 57 lbs. / 19.14 cubic feet -Armless - 53 lbs. / 19.14 cubic feet • Task Stool <ul style="list-style-type: none"> -With arms - 61 lbs. / 22.1 cubic feet -Armless - 57 lbs. / 22.1 cubic feet

Fern At-A-Glance

General Specifications

STANDARD MOBILITY AND ADJUSTABILITY

Seat Height Adjustment

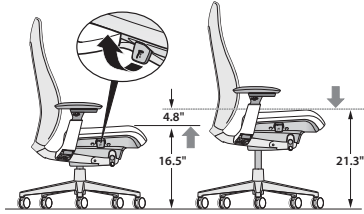

Features:

- Pneumatic seat height adjustment.
- Seat height adjusts 5"(127mm) from 16.5" to 21.5"(406mm-533mm) in standard models. Low-position adjusts from 15" to 17.5"(38mm-44mm).

Benefits:

- Ensures the comfort of the lower limbs by avoiding pressure on the underside of the thigh caused by a seat pan that is too high, or decreased thigh-to-torso angle if the seat is too low.
- Accommodates users between approximately 4'11"(1499mm) and 6'3"(1905mm) tall to provide good leg circulation.
- Seat height adjustment is important in setting the proper hand position and allowing for proper sitting eye height as well.

Seat Depth Adjustment

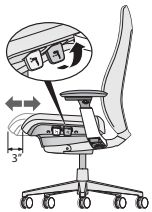

Features:

- Optional seat depth has 3"(76mm) seat depth range. Fixed seat also available.

Benefit:

- Supports the thighs, allows users to rest against the seat back for back support, and avoids pressure on the back of the knees of small to tall users.

Balanced 3-Point Tilt

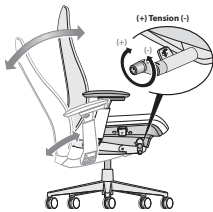

Features:

- Balanced 3-point tilt mechanism.
- Back reclines 24° from the upright position.
- Seat pan moves downward 5° from the initial position.

Benefits:

- Comfortable relaxed posture.
- Recline allows for the opening of the user's chest cavity providing good airflow to promote alertness.
- Users' feet remain flat on the floor.

Tilt Tension Control

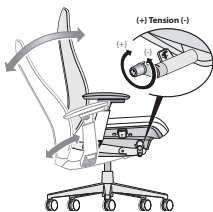

Features:

- Regulates the amount of resistance felt when leaning back in the chair and the effort required to recline the chair backwards.

Benefit:

- Personalized support to accommodate users of different body types and different work styles.

Edgeless Back Design

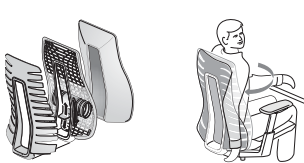

Features:

- Edgeless design provides flexibility.
- Patented design with flexible fronds and cradle system provide total back support.

Benefit:

- Encourages movement, eliminates pressure point from hard edge.

Back Support/ Lumbar Adjustment

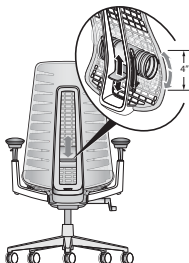

Features:

- Total back support, providing pelvic, to lumbar to thoracic support (upper back).
- Optional height adjustable lumbar.
- Range of 4"(102mm) of height adjustment.

Benefits:

- Provides additional support in the lower back.
- Lumbar adjustment maintains the natural curvature of the spine at the lower back and allows users to choose the support that feels right for them.
- Integrated passive pelvic support rotates the pelvis forward to maintain the natural spine shape.

Fern At-A-Glance

General Specifications

STANDARD MOBILITY AND ADJUSTABILITY

Back Stop



Features:

- Back Stop stops in 5 positions - upright and every 7° of back angle.

Benefit:

- Allows users the choice of selecting an upright position or limiting the amount of recline while performing different tasks.

Forward Tilt



Features:

- Optional forward tilt allows seat pan to move downward 5° from the initial position.

Benefit:

- Allows user the opportunity to vary their posture throughout the day.

4D Arm

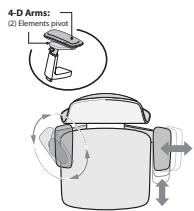

Features:

- Optional 4D arm adjusts in 4 ways:
 - Height adjustment 4.8”(122mm)
 - Side-to-side arm cap adjustment range: 15”(381mm) [7.5”(191mm) each arm cap]
 - Front-to-back adjustment range: 3.5”(89mm)
 - Pivoting 40° in and 40° out

Benefits:

- Height adjustment offers users varying elbow rest heights so that users avoid lifting their shoulders or leaning sideways to get arm support.
- Front-to-back adjustment adjusts the armrest length, which is important because it allows users to get close to the worksurface while maintaining the effective use of the backrest.
- Side-to-side adjustment ensures a comfortable resting position for the arms with proper support of the forearm while allowing for easy entry/exit of the chair.
- Pivoting provides proper support of the forearm when performing tasks involving keying and mousing.

Height Adjustable Arm

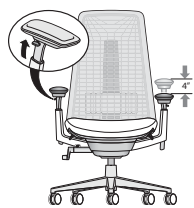

Features:

- Optional height adjustable arms adjust 4.8”(122mm) vertically.

Benefit:

- Height adjustment accommodates users with varying elbow rest heights so that users avoid lifting their shoulders or leaning sideways to get arm support.

Base

Standard Plastic Base

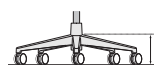

Colors:

Fog, Black

Casters:

Hard: Black or two-tone grey

Soft: Black

Optional Aluminum Base

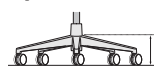

Colors:

Painted Metallic Silver, Metallic Champagne, Pitch (textured black), polished aluminum

Casters:

Hard: Black or two-tone grey

Soft: Black

Low Position Base (Aluminum only)

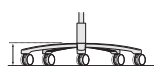

Colors:

Painted Metallic Silver, Metallic Champagne, Pitch (textured black)

Casters:

Hard: Black or two-tone grey

Soft: Black

Fern

General Specifications
UPHOLSTERY / AESTHETIC OPTIONS

Fern Plastic Model

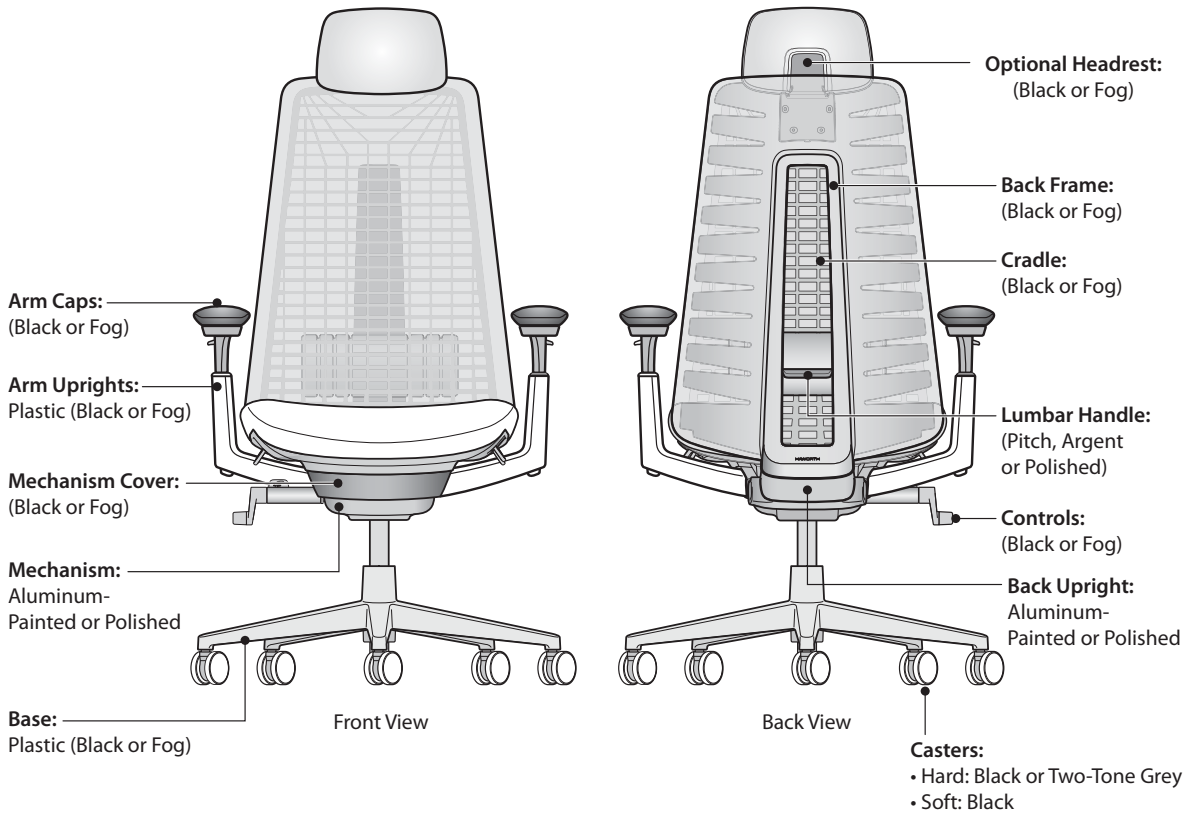

Fern Aluminum Model

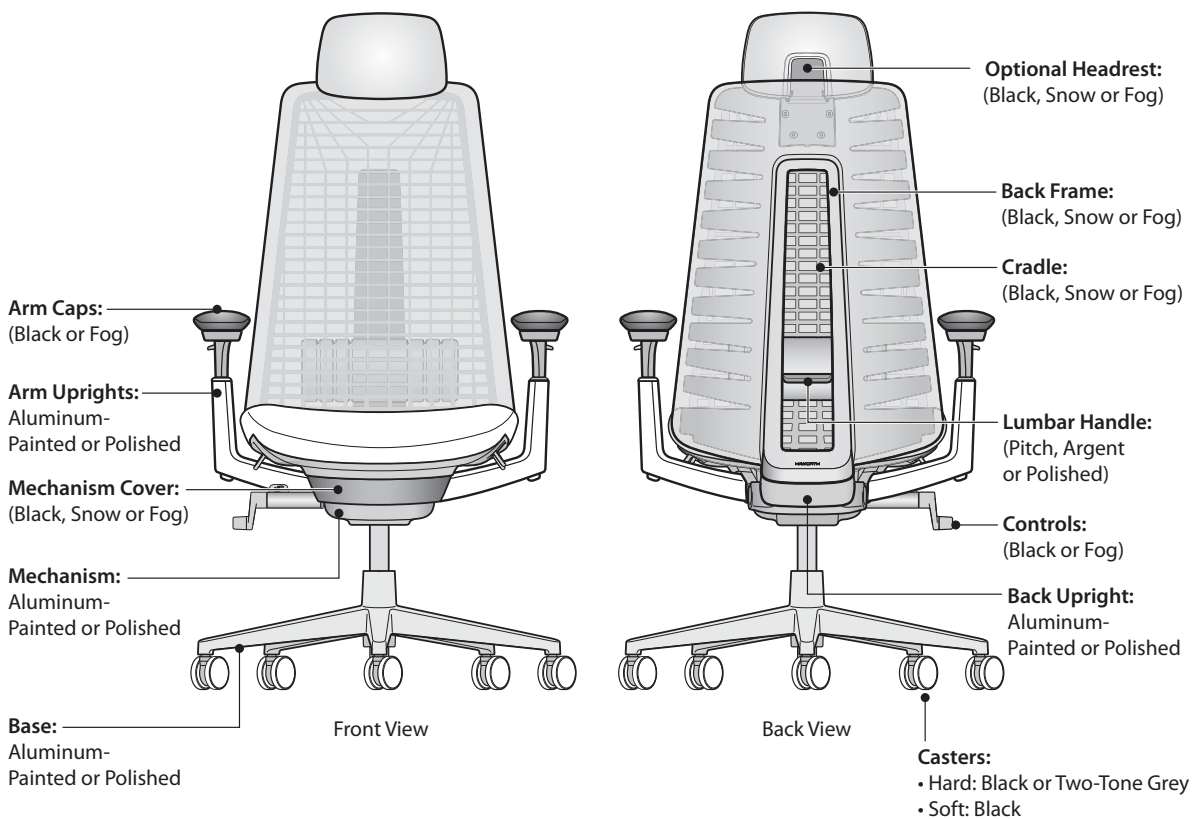

This page intentionally blank

Fern

Task Chair with 4D Arms — Plastic Base Model



SFT-U0-7S01A

1st Trim Color (Plastic)	Arm Cap/Levers	Lumbar Handle
TR-F Black	TR-F Black	TR-TF Pitch
TR-7 Fog	TR-7 Fog	TR-AR Argent

Dimensions

- *SH: 16.5"-21.5" (419mm-546mm)
- H: 41.5"-47" (1054mm-1194mm)
- D: 28.5"(724mm)
- W: 29"(737mm)
- *SW: 19.9"(505mm)
- *AH: 6.7"-11.5" (170mm-292mm)
- *SD: 15.5"-18.5" (394mm-470mm)

* All measurements taken with the BIFMA chair measuring device.

Features

- Back: Flexible back with built in fronds wrapped in lofted mesh, knit or faux leather.
- Seat: Flexible seat pan with standard upholstered foam.
- Standard fixed seat. Optional seat depth adjustment (3"(76mm) range).
- Base: Plastic five-star base. Available in Black or Fog.
- Optional height adjustable lumbar support (4"(102mm) adjustment).
- Arms: 4D arms with plastic upright.
 - Move fore, aft, side to side and pivot in and out.
 - Height adjustment range of 4.8"(122mm).
- Arm Caps: Standard with soft arm caps.
- Optional headrest has an upholstered front with a plastic back. Headrest material and trim color are matched to the back.
- Mechanism: Synchronized 3-point tilt; standard tilt tension adjustment.
- Height Adjustment: Pneumatic. Range: 16.5"-21.5"(419mm-546mm).
- Back Stop: 5 positions.
- Optional Forward Tilt (with Back Stop): 5° downward from initial position.
- Casters: Hard casters in black or two-tone grey; Soft casters black only.
- COM yardage / COL square footage: (Seat only) 0.71/8

To Order, Specify:

1) Product number, including;

1) Caster Option:

- 5 Hard Casters (Black)
- 6 Soft Casters (Black), add \$45.00 to list
- 7 Hard Two-Tone Casters (Grey)

- 2) Fabric surface and color (seat).
- 3) Mesh, knit or faux leather color (back).
- 4) Plastic trim color (back frame/cradle/arm uprights/base).
- 5) Aluminum trim color (back upright and mechanism). (Add \$105.33 list for polished aluminum back upright and mechanism.)

Specification Tip

- When Polished Aluminum trim is specified, lumbar handle will default to Polished Aluminum.

Description	Number	Fabric Grade								Leather Grade A	Leather Grade B
		A	B	C	D	E	F	G	H		
Mesh Back, No Lumbar Adjustment											
Back Stop w/Seat Depth Adjustment	SFT-U0-7S01A	\$1427.92	\$1467.71	\$1509.85	\$1530.91	\$1546.13	\$1583.59	\$1618.70	\$1711.15	\$1776.70	\$1942.90
Back Stop Forward Tilt w/Seat Depth Adjustment	SFT-U0-7S04A	1521.55	1561.34	1603.48	1624.54	1639.76	1677.22	1712.33	1804.78	1870.33	2036.53
Knit Back, No Lumbar Adjustment											
Back Stop w/Seat Depth Adjustment	SFT-UU-7S01A	\$1615.12	\$1654.91	\$1697.05	\$1718.11	\$1733.33	\$1770.79	\$1805.90	\$1898.35	\$1963.90	\$2130.10
Back Stop Forward Tilt w/Seat Depth Adjustment	SFT-UU-7S04A	1708.75	1748.54	1790.68	1811.74	1826.96	1864.42	1899.53	1991.98	2057.53	2223.73
Mesh Back, Lumbar Adjustment											
Back Stop w/Seat Depth Adjustment	SFT-U0-7S11A	\$1533.25	\$1573.04	\$1615.18	\$1636.24	\$1651.46	\$1688.92	\$1724.03	\$1816.48	\$1882.03	\$2048.23
Back Stop Forward Tilt w/Seat Depth Adjustment	SFT-U0-7S14A	1626.88	1666.67	1708.81	1729.87	1745.09	1782.55	1817.66	1910.11	1975.66	2141.86
Knit Back, Lumbar Adjustment											
Back Stop w/Seat Depth Adjustment	SFT-UU-7S11A	\$1720.45	\$1760.24	\$1802.38	\$1823.44	\$1838.66	\$1876.12	\$1911.23	\$2003.68	\$2069.23	\$2235.43
Back Stop Forward Tilt w/Seat Depth Adjustment	SFT-UU-7S14A	1814.08	1853.87	1896.01	1917.07	1932.29	1969.75	2004.86	2097.31	2162.86	2329.06

The following options require modification of the product number.

- Fixed seat To specify, change the 10th digit from an **A** to **F**; **Example:** SFT-U0-7S01F5
- Faux Leather back To specify, change the fifth digit in the product number to **U**; **Example:** SFT-UU-7S01A5 (Wellington; add \$134.60 list, Brisa; add \$347.62 list)
- Headrest To specify, change the third digit from a **T** to an **E**; **Example:** SFE-U0-7S01A5 (Mesh; add \$157.56 list, Faux Leather; add \$204.37 list)
- Stain repellent (Seat only) To specify, add **P** to the end of the product number and add \$40.97 list; **Example:** SFT-U0-7S01A5P

Fern

Task Chair with 4D Arms — Aluminum Base Model



SFT-U0-7501A

Dimensions

- *SH: 16.5"-21.5"
(419mm-546mm)
- H: 41.5"-47"
(1054mm-1194mm)
- D: 28.5"(724mm)
- W: 29"(737mm)
- *SW: 19.9"(505mm)
- *AH: 6.7"-11.5"
(170mm-292mm)
- *SD: 15.5"-18.5"
(394mm-470mm)

Low position seat height:
15"-17.5"
(381mm-445mm)

* All measurements taken with the BIFMA chair measuring device.

Features

- Back: Flexible back with built in fronds wrapped in lofted mesh, knit or faux leather.
- Seat: Flexible seat pan with standard upholstered foam.
- Standard fixed seat. Optional seat depth adjustment (3"(76mm) range).
- Base: Aluminum five-star base.
- Optional height adjustable lumbar support (4"(102mm) adjustment).
- Arms: 4D arms with aluminum upright.
–Move fore, aft, side to side and pivot in and out.
–Height adjustment range of 4.8"(122mm).
- Arm Caps: Standard with soft arm caps.
- Optional headrest has an upholstered front with a plastic back. Headrest material and trim color are matched to the back.
- Mechanism: Synchronized 3-point tilt; standard tilt tension adjustment.
- Height Adjustment: Pneumatic or optional low position. Range: 15"-17.5"(381mm-445mm).
- Back Stop: 5 positions.
- Optional Forward Tilt (with Back Stop): 5° downward from initial position.
- Casters: Hard casters in black or two-tone grey; Soft casters black only.
- COM yardage / COL square footage:
(Seat only) 0.71/8

To Order, Specify:

1) Product number, including;

1) Caster Option: Standard Base

- 1** Std. Base Hard Casters (Black)
- 2** Std. Base Soft Casters (Black), add **\$45.00** to list
- T** Std. Base Hard Two-Tone Casters (Grey)

Low Base

- 3** Low Base, Hard Casters (Black)
- 4** Low Base, Soft Casters (Black), add **\$45.00** to list

- 2) Fabric surface and color (seat).
- 3) Mesh, knit or faux leather color (back).
- 4) Plastic trim color (back frame/cradle). (Add **\$64.37** list for Snow TR-UFM for back frame/cradle.)
- 5) Aluminum trim color (back and arm upright/mechanism/base). (Add **\$105.33** list for polished aluminum.)

1st Trim Color (Plastic)	Arm Cap/Levers	Lumbar Handle
TR-F Black	TR-F Black	TR-TF Pitch
TR-7 Fog	TR-7 Fog	TR-AR Argent
TR-UFM Snow	TR-7 Fog	TR-FS Snowfall
TR-UFM Snow w/2nd trim PM-P Polished Aluminum	TR-7 Fog	PM-P Polished Aluminum

Specification Tip

- When Polished Aluminum trim is specified, lumbar handle will default to Polished Aluminum.

Description	Number 1	Fabric Grade								Leather Grade A	Leather Grade B
		A	B	C	D	E	F	G	H		
Mesh Back, No Lumbar Adjustment											
Back Stop w/Seat Depth Adjustment	SFT-U0-7501A	\$1605.82	\$1645.61	\$1687.75	\$1708.81	\$1724.03	\$1761.49	\$1796.60	\$1889.05	\$1954.60	\$2120.80
Back Stop Forward Tilt w/Seat Depth Adjustment	SFT-U0-7504A	1699.45	1739.24	1781.38	1802.44	1817.66	1855.12	1890.23	1982.68	2048.23	2214.43
Knit Back, No Lumbar Adjustment											
Back Stop w/Seat Depth Adjustment	SFT-UU-7501A	\$1793.02	\$1832.81	\$1874.95	\$1896.01	\$1911.23	\$1948.69	\$1983.80	\$2076.25	\$2141.80	\$2308.00
Back Stop Forward Tilt w/Seat Depth Adjustment	SFT-UU-7504A	1886.65	1926.44	1968.58	1989.64	2004.86	2042.32	2077.43	2169.88	2235.43	2401.63
Mesh Back, Lumbar Adjustment											
Back Stop w/Seat Depth Adjustment	SFT-U0-7511A	\$1711.15	\$1750.94	\$1793.08	\$1814.14	\$1829.36	\$1866.82	\$1901.93	\$1994.38	\$2059.93	\$2226.13
Back Stop Forward Tilt w/Seat Depth Adjustment	SFT-U0-7514A	1804.78	1844.57	1886.71	1907.77	1922.99	1960.45	1995.56	2088.01	2153.56	2319.76
Knit Back, Lumbar Adjustment											
Back Stop w/Seat Depth Adjustment	SFT-UU-7511A	\$1898.35	\$1938.14	\$1980.28	\$2001.34	\$2016.56	\$2054.02	\$2089.13	\$2181.58	\$2247.13	\$2413.33
Back Stop Forward Tilt w/Seat Depth Adjustment	SFT-UU-7514A	1991.98	2031.77	2073.91	2094.97	2110.19	2147.65	2182.76	2275.21	2340.76	2506.96

The following options require modification of the product number.

- Fixed seat To specify, change the 10th digit from an **A** to **F**; **Example:** SFT-U0-7501**F5**
- Faux Leather back To specify, change the fifth digit in the product number to **U**; **Example:** SFT-UU-7501**A5** (Wellington; add **\$134.60** list, Brisa; add **\$347.62** list)
- Headrest To specify, change the third digit from a **T** to an **E**; **Example:** SFE-U0-7501**A5** (Mesh; add **\$157.56** list, Faux Leather; add **\$204.37** list)
- Stain repellent (Seat only) To specify, add **P** to the end of the product number and add **\$40.97** list; **Example:** SFT-U0-7501**A5P**

Fern

Task Chair with Height Adjustable Arms — Plastic Base Model



SFT-U0-4S01A

1st Trim Color (Plastic)	Arm Cap/Levers	Lumbar Handle
TR-F Black	TR-F Black	TR-TF Pitch
TR-7 Fog	TR-7 Fog	TR-AR Argent

Dimensions

- *SH: 16.5"-21.5"
(419mm-546mm)
- H: 41.5"-47"
(1054mm-1194mm)
- D: 28.5"(724mm)
- W: 29"(737mm)
- *SW: 19.9"(505mm)
- *AH: 6.7"-11.5"
(170mm-292mm)
- *SD: 15.5"-18.5"
(394mm-470mm)

* All measurements taken with the BIFMA chair measuring device.

Features

- Back: Flexible back with built in fronds wrapped in lofted mesh, knit or faux leather.
- Seat: Flexible seat pan with standard upholstered foam.
- Standard fixed seat. Optional seat depth adjustment (3"(76mm) range).
- Base: Plastic five-star base. Available in Black or Fog.
- Optional height adjustable lumbar support (4"(102mm) adjustment).
- Arms: Height Adjustable with soft arm caps. Adjustment range of 4.8"(122mm).
- Optional headrest has an upholstered front with a plastic back. Headrest material and trim color are matched to the back.
- Mechanism: Synchronized 3-point tilt; standard tilt tension adjustment.
- Height Adjustment: Pneumatic. Range: 16.5"-21.5"(419mm-546mm).
- Back Stop: 5 positions.
- Optional Forward Tilt (with Back Stop): 5° downward from initial position.
- Casters: Hard casters in black or two-tone grey; Soft casters black only.
- COM yardage / COL square footage: (Seat only) 0.71/8

To Order, Specify:

- 1) Product number, including;
 - 1** **Caster Option:**
 - 5** Hard Casters (Black)
 - 6** Soft Casters (Black), add **\$45.00** to list
 - 7** Hard Two-Tone Casters (Grey)
- 2) Fabric surface and color (seat).
- 3) Mesh, knit or faux leather color (back).
- 4) Plastic trim color (back frame/cradle/arm uprights/base).
- 5) Aluminum trim color (back upright and mechanism). (Add **\$105.33** list for polished aluminum back upright and mechanism.)

Specification Tip

- When Polished Aluminum trim is specified, lumbar handle will default to Polished Aluminum.

Description	Number 1	Fabric Grade								Leather Grade A	Leather Grade B
		A	B	C	D	E	F	G	H		
Mesh Back, No Lumbar Adjustment											
Back Stop w/Seat Depth Adjustment	SFT-U0-4S01A	\$1398.68	\$1438.47	\$1480.61	\$1501.67	\$1516.89	\$1554.35	\$1589.46	\$1681.91	\$1747.46	\$1913.66
Back Stop Forward Tilt w/Seat Depth Adjustment	SFT-U0-4S04A	1492.31	1532.10	1574.24	1595.30	1610.52	1647.98	1683.09	1775.54	1841.09	2007.29
Knit Back, No Lumbar Adjustment											
Back Stop w/Seat Depth Adjustment	SFT-UU-4S01A	\$1585.88	\$1625.67	\$1667.81	\$1688.87	\$1704.09	\$1741.55	\$1776.66	\$1869.11	\$1934.66	\$2100.86
Back Stop Forward Tilt w/Seat Depth Adjustment	SFT-UU-4S04A	1679.51	1719.30	1761.44	1782.50	1797.72	1835.18	1870.29	1962.74	2028.29	2194.49
Mesh Back, Lumbar Adjustment											
Back Stop w/Seat Depth Adjustment	SFT-U0-4S11A	\$1504.01	\$1543.80	\$1585.94	\$1607.00	\$1622.22	\$1659.68	\$1694.79	\$1787.24	\$1852.79	\$2018.99
Back Stop Forward Tilt w/Seat Depth Adjustment	SFT-U0-4S14A	1597.64	1637.43	1679.57	1700.63	1715.85	1753.31	1788.42	1880.87	1946.42	2112.62
Knit Back, Lumbar Adjustment											
Back Stop w/Seat Depth Adjustment	SFT-UU-4S11A	\$1691.21	\$1731.00	\$1773.14	\$1794.20	\$1809.42	\$1846.88	\$1881.99	\$1974.44	\$2039.99	\$2206.19
Back Stop Forward Tilt w/Seat Depth Adjustment	SFT-UU-4S14A	1784.84	1824.63	1866.77	1887.83	1903.05	1940.51	1975.62	2068.07	2133.62	2299.82

The following options require modification of the product number.

- Fixed seat To specify, change the 10th digit from an **A** to **F**; **Example:** SFT-U0-4S01F5
- Faux Leather back To specify, change the fifth digit in the product number to **U**; **Example:** SFT-UU-4S01A5 (Wellington; add **\$134.60** list, Brisa; add **\$347.62** list)
- Headrest To specify, change the third digit from a **T** to an **E**; **Example:** SFE-U0-4S01A5 (Mesh; add **\$157.56** list, Faux Leather; add **\$204.37** list)
- Stain repellent (Seat only) To specify, add **P** to the end of the product number and add **\$40.97** list; **Example:** SFT-U0-4S01kA5P

Fern

Task Chair with Height Adjustable Arms — Aluminum Base Model



SFT-U0-4S01A

Dimensions

- *SH: 16.5"-21.5"
(419mm-546mm)
- H: 41.5"-47"
(1054mm-1194mm)
- D: 28.5"(724mm)
- W: 29"(737mm)
- *SW: 19.9"(505mm)
- *AH: 6.7"-11.5"
(170mm-292mm)
- *SD: 15.5"-18.5"
(394mm-470mm)

Low position seat height:
15"-17.5"
(381mm-445mm)

* All measurements taken with the BIFMA chair measuring device.

Features

- Back: Flexible back with built in fronds wrapped in lofted mesh, knit or faux leather.
- Seat: Flexible seat pan with standard upholstered foam.
- Standard fixed seat. Optional seat depth adjustment (3"(76mm) range).
- Base: Aluminum five-star base.
- Optional height adjustable lumbar support (4"(102mm) adjustment).
- Arms: Height Adjustable with soft arm caps. Adjustment range of 4.8"(122mm).
- Optional headrest has an upholstered front with a plastic back. Headrest material and trim color are matched to the back.
- Mechanism: Synchronized 3-point tilt; standard tilt tension adjustment.
- Height Adjustment: Pneumatic or optional low position. Range: 15"-17.5"(381mm-445mm).
- Back Stop: 5 positions.
- Optional Forward Tilt (with Back Stop): 5° downward from initial position.
- Casters: Hard casters in black or two-tone grey; Soft casters black only.
- COM yardage / COL square footage: (Seat only) 0.71/8

To Order, Specify:

1) Product number, including;

1 Caster Option: Standard Base

- 1 Std. Base Hard Casters (Black)
- 2 Std. Base Soft Casters (Black), add **\$45.00** to list
- T Std. Hard Base Two-Tone Casters (Grey)

Low Base

- 3 Low Base, Hard Casters (Black)
- 4 Low Base, Soft Casters (Black), add **\$45.00** to list

- 2) Fabric surface and color (seat).
- 3) Mesh, knit or faux leather color (back).
- 4) Plastic trim color (back frame/cradle). (Add **\$64.37** list for Snow TR-UFM for back frame/cradle.)
- 5) Aluminum trim color (back and arm upright/mechanism/base). (Add **\$105.33** list for polished aluminum.)

1st Trim Color (Plastic)	Arm Cap/Levers	Lumbar Handle
TR-F Black	TR-F Black	TR-TF Pitch
TR-7 Fog	TR-7 Fog	TR-AR Argent
TR-UFM Snow	TR-7 Fog	TR-FS Snowfall
TR-UFM Snow w/2nd trim PM-P Polished Aluminum	TR-7 Fog	PM-P Polished Aluminum

Specification Tip

- When Polished Aluminum trim is specified, lumbar handle will default to Polished Aluminum.

Description	Number 1	Fabric Grade								Leather Grade A	Leather Grade B
		A	B	C	D	E	F	G	H		
Mesh Back, No Lumbar Adjustment											
Back Stop w/Seat Depth Adjustment	SFT-U0-4S01A	\$1576.58	1616.37	1658.51	1679.57	1694.79	1732.25	1767.36	1859.81	1925.36	2091.56
Back Stop Forward Tilt w/Seat Depth Adjustment	SFT-U0-4S04A	1670.21	1710.00	1752.14	1773.20	1788.42	1825.88	1860.99	1953.44	2018.99	2185.19
Knit Back, No Lumbar Adjustment											
Back Stop w/Seat Depth Adjustment	SFT-UU-4S01A	\$1763.78	1803.57	1845.71	1866.77	1881.99	1919.45	1954.56	2047.01	2112.56	2278.76
Back Stop Forward Tilt w/Seat Depth Adjustment	SFT-UU-4S04A	1857.41	1897.20	1939.34	1960.40	1975.62	2013.08	2048.19	2140.64	2206.19	2372.39
Mesh Back, Lumbar Adjustment											
Back Stop w/Seat Depth Adjustment	SFT-U0-4S11A	\$1681.91	1721.70	1763.84	1784.90	1800.12	1837.58	1872.69	1965.14	2030.69	2196.89
Back Stop Forward Tilt w/Seat Depth Adjustment	SFT-U0-4S14A	1775.54	1815.33	1857.47	1878.53	1893.75	1931.21	1966.32	2058.77	2124.32	2290.52
Knit Back, Lumbar Adjustment											
Back Stop w/Seat Depth Adjustment	SFT-UU-4S11A	\$1869.11	1908.90	1951.04	1972.10	1987.32	2024.78	2059.89	2152.34	2217.89	2384.09
Back Stop Forward Tilt w/Seat Depth Adjustment	SFT-UU-4S14A	1962.74	2002.53	2044.67	2065.73	2080.95	2118.41	2153.52	2245.97	2311.52	2477.72

The following options require modification of the product number.

- Fixed seat To specify, change the 10th digit from an **A** to **F**; **Example:** SFT-U0-7S01F5
- Faux Leather back To specify, change the fifth digit in the product number to **U**; **Example:** SFT-UU-7S01A5 (Wellington; add **\$134.60** list, Brisa; add **\$347.62** list)
- Headrest To specify, change the third digit from a **T** to an **E**; **Example:** SFE-U0-7S01A5 (Mesh; add **\$157.56** list, Faux Leather; add **\$204.37** list)
- Stain repellent (Seat only) To specify, add **P** to the end of the product number and add **\$40.97** list; **Example:** SFT-U0-7S01A5P

Fern

Task Chair with Fixed Arms — Plastic Base Model



SFT-U0-1S01A

1st Trim Color (Plastic)	Arm Cap/Levers	Lumbar Handle
TR-F Black	TR-F Black	TR-TF Pitch
TR-7 Fog	TR-7 Fog	TR-AR Argent

Dimensions

- *SH: 16.5"-21.5" (419mm-546mm)
- H: 41.5"-47" (1054mm-1194mm)
- D: 28.5"(724mm)
- W: 29"(737mm)
- *SW: 19.9"(505mm)
- *AH: 9"(229mm)
- *SD: 15.5"-18.5" (394mm-470mm)

* All measurements taken with the BIFMA chair measuring device.

Features

- Back: Flexible back with built in fronds wrapped in lofted mesh, knit or faux leather.
- Seat: Flexible seat pan with standard upholstered foam.
- Standard fixed seat. Optional seat depth adjustment (3"(76mm) range).
- Base: Plastic five-star base. Available in Black or Fog.
- Optional height adjustable lumbar support (4"(102mm) adjustment).
- Arms: Fixed aluminum arms with soft arm caps.
- Optional leather arm cap available when ordering a leather seat. Leather arm cap coordinates with leather seat selection.
- Optional headrest has an upholstered front with a plastic back. Headrest material and trim color are matched to the back.
- Mechanism: Synchronized 3-point tilt; standard tilt tension adjustment.
- Height Adjustment: Pneumatic. Range: 15"-17.5"(381mm-445mm).
- Back Stop: 5 positions.
- Optional Forward Tilt (with Back Stop): 5° downward from initial position.
- Casters: Hard casters in black or two-tone grey; Soft casters black only.
- COM yardage / COL square footage: (Seat only) 0.71/8

To Order, Specify:

- 1) Product number, including;
 - 1** **Caster Option:**
 - 5** Hard Casters (Black)
 - 6** Soft Casters (Black), add **\$45.00** to list
 - 7** Hard Two-Tone Casters (Grey)
- 2) Fabric surface and color (seat).
- 3) Mesh, knit or faux leather color (back).
- 4) Plastic trim color (back frame/cradle/base).
- 5) Aluminum trim color (back upright/arm uprights/mechanism). (Add **\$105.33** list for polished aluminum back upright and mechanism.)

Specification Tip

- When Polished Aluminum trim is specified, lumbar handle will default to Polished Aluminum.

Description	Number 1	Fabric Grade								Leather Grade A	Leather Grade B
		A	B	C	D	E	F	G	H		
Mesh Back, No Lumbar Adjustment											
Back Stop w/Seat Depth Adjustment	SFT-U0-1S01A	\$1381.11	\$1420.90	\$1463.04	\$1484.10	\$1499.32	\$1536.78	\$1571.89	\$1664.34	\$1729.89	\$1896.09
Back Stop Forward Tilt w/Seat Depth Adjustment	SFT-U0-1S04A	1474.74	1514.53	1556.67	1577.73	1592.95	1630.41	1665.52	1757.97	1823.52	1989.72
Knit Back, No Lumbar Adjustment											
Back Stop w/Seat Depth Adjustment	SFT-UU-1S01A	\$1568.31	\$1608.10	\$1650.24	\$1671.30	\$1686.52	\$1723.98	\$1759.09	\$1851.54	\$1917.09	\$2083.29
Back Stop Forward Tilt w/Seat Depth Adjustment	SFT-UU-1S04A	1661.94	1701.73	1743.87	1764.93	1780.15	1817.61	1852.72	1945.17	2010.72	2176.92
Mesh Back, Lumbar Adjustment											
Back Stop w/Seat Depth Adjustment	SFT-U0-1S11A	\$1486.44	\$1526.23	\$1568.37	\$1589.43	\$1604.65	\$1642.11	\$1677.22	\$1769.67	\$1835.22	\$2001.42
Back Stop Forward Tilt w/Seat Depth Adjustment	SFT-U0-1S14A	1580.07	1619.86	1662.00	1683.06	1698.28	1735.74	1770.85	1863.30	1928.85	2095.05
Knit Back, Lumbar Adjustment											
Back Stop w/Seat Depth Adjustment	SFT-UU-1S11A	\$1673.64	\$1713.43	\$1755.57	\$1776.63	\$1791.85	\$1829.31	\$1864.42	\$1956.87	\$2022.42	\$2188.62
Back Stop Forward Tilt w/Seat Depth Adjustment	SFT-UU-1S14A	1767.27	1807.06	1849.20	1870.26	1885.48	1922.94	1958.05	2050.50	2116.05	2282.25

The following options require modification of the product number.

- Fixed seat To specify, change the 10th digit from an **A** to **F**; **Example:** SFT-U0-1S01**F5**
- Leather arm cap To specify, change the 7th digit from **S** to **L**; **Example:** SFT-U0-1L01A5 (matches required Leather seat), add **\$81.93** list
- Faux Leather back To specify, change the fifth digit in the product number to **U**; **Example:** SFT-UU-1S01A5 (Wellington; add **\$134.60** list, Brisa; add **\$347.62** list)
- Headrest To specify, change the third digit from a **T** to an **E**; **Example:** SFE-U0-1S01A5 (Mesh; add **\$157.56** list, Faux Leather; add **\$204.37** list)
- Stain repellent (Seat only) To specify, add **P** to the end of the product number and add **\$40.97** list; **Example:** SFT-U0-1S02A5**P**

Fern

Task Chair with Fixed Arms — Aluminum Base Model



SFT-U0-1S01A

Dimensions

- *SH: 16.5"-21.5"
(419mm-546mm)
- H: 41.5"-47"
(1054mm-1194mm)
- D: 28.5"(724mm)
- W: 29"(737mm)
- *SW: 19.9"(505mm)
- *AH: 9"(229mm)
- *SD: 15.5"-18.5"
(394mm-470mm)

Low position seat height:
15"-17.5"(381mm-445mm)

* All measurements taken with the BIFMA chair measuring device.

Features

- Back: Flexible back with built in fronds wrapped in lofted mesh, knit or faux leather.
- Seat: Flexible seat pan with standard upholstered foam.
- Standard fixed seat. Optional seat depth adjustment (3"(76mm) range).
- Base: Aluminum five-star base.
- Optional height adjustable lumbar support (4"(102mm) adjustment).
- Arms: Fixed with soft arm caps.
- Optional leather arm cap available when ordering a leather seat. Leather arm cap coordinates with leather seat selection.
- Optional headrest has an upholstered front with a plastic back. Headrest material and trim color are matched to the back.
- Mechanism: Synchronized 3-point tilt; standard tilt tension adjustment.
- Height Adjustment: Pneumatic or optional low position. Range: 15"-17.5"(381mm-445mm).
- Back Stop: 5 positions.
- Optional Forward Tilt (with Back Stop): 5° downward from initial position.
- Casters: Hard casters in black or two-tone grey; Soft casters black only.
- COM yardage / COL square footage: (Seat only) 0.71/8

To Order, Specify:

1) Product number, including;

1 Caster Option: Standard Base

- 1 Std. Base Hard Casters (Black)
- 2 Std. Base Soft Casters (Black), add **\$45.00** to list
- T Std. Base Hard Two-Tone Casters (Grey)

Low Base

- 3 Low Base, Hard Casters (Black)
- 4 Low Base, Soft Casters (Black), add **\$45.00** to list

2) Fabric surface and color (seat).

3) Mesh, knit or faux leather color (back).

4) Plastic trim color (back frame/cradle). (Add **\$64.37** list for Snow TR-UFM for back frame/cradle/arm caps.)

5) Aluminum trim color (back and arm upright/mechanism/base). (Add **\$105.33** list for polished aluminum back upright and mechanism.)

1st Trim Color (Plastic)	Arm Cap/Levers	Lumbar Handle
TR-F Black	TR-F Black	TR-TF Pitch
TR-7 Fog	TR-7 Fog	TR-AR Argent
TR-UFM Snow	TR-7 Fog	TR-FS Snowfall
TR-UFM Snow w/2nd trim PM-P Polished Aluminum	TR-7 Fog	PM-P Polished Aluminum

Specification Tip

- When Polished Aluminum trim is specified, lumbar handle will default to Polished Aluminum.

Description	Number	1	Fabric Grade								Leather Grade A	Leather Grade B
			A	B	C	D	E	F	G	H		
Mesh Back, No Lumbar Adjustment												
Back Stop w/Seat Depth Adjustment	SFT-U0-1S01A		\$1559.01	\$1598.80	\$1640.94	\$1662.00	\$1677.22	\$1714.68	\$1749.79	\$1842.24	\$1907.79	\$2073.99
Back Stop Forward Tilt w/Seat Depth Adjustment	SFT-U0-1S04A		1652.64	1692.43	1734.57	1755.63	1770.85	1808.31	1843.42	1935.87	2001.42	2167.62
Knit Back, No Lumbar Adjustment												
Back Stop w/Seat Depth Adjustment	SFT-UU-1S01A		\$1746.21	\$1786.00	\$1828.14	\$1849.20	\$1864.42	\$1901.88	\$1936.99	\$2029.44	\$2094.99	\$2261.19
Back Stop Forward Tilt w/Seat Depth Adjustment	SFT-UU-1S04A		1839.84	1879.63	1921.77	1942.83	1958.05	1995.51	2030.62	2123.07	2188.62	2354.82
Mesh Back, Lumbar Adjustment												
Back Stop w/Seat Depth Adjustment	SFT-U0-1S11A		\$1664.34	\$1704.13	\$1746.27	\$1767.33	\$1782.55	\$1820.01	\$1855.12	\$1947.57	\$2013.12	\$2179.32
Back Stop Forward Tilt w/Seat Depth Adjustment	SFT-U0-1S14A		1757.97	1797.76	1839.90	1860.96	1876.18	1913.64	1948.75	2041.20	2106.75	2272.95
Knit Back, Lumbar Adjustment												
Back Stop w/Seat Depth Adjustment	SFT-UU-1S11A		\$1851.54	\$1891.33	\$1933.47	\$1954.53	\$1969.75	\$2007.21	\$2042.32	\$2134.77	\$2200.32	\$2366.52
Back Stop Forward Tilt w/Seat Depth Adjustment	SFT-UU-1S14A		1945.17	1984.96	2027.10	2048.16	2063.38	2100.84	2135.95	2228.40	2293.95	2460.15

The following options require modification of the product number.

- Fixed seat To specify, change the 10th digit from an **A** to **F**; **Example:** SFT-U0-1S01F1
- Leather arm cap To specify, change the 7th digit from **S** to **L**; **Example:** SFT-U0-1L01A1 (matches required Leather seat), add **\$81.93** list
- Faux Leather back To specify, change the fifth digit in the product number to **U**; **Example:** SFT-UU-1S01A1 (Wellington; add **\$134.60** list, Brisa; add **\$347.62** list)
- Headrest To specify, change the third digit from a **T** to an **E**; **Example:** SFE-U0-1S01A1 (Mesh; add **\$157.56** list, Faux Leather; add **\$204.37** list)
- Stain repellent (Seat only) To specify, add **P** to the end of the product number and add **\$40.97** list; **Example:** SFT-U0-1S01A1P

Fern

Task Chair without Arms — Plastic Base Model



SFT-UO-0N01A

1st Trim Color (Plastic)	Levers	Lumbar Handle
TR-F Black	TR-F Black	TR-TF Pitch
TR-7 Fog	TR-7 Fog	TR-AR Argent

Dimensions

- *SH: 16.5"-21.5" (419mm-546mm)
- H: 41.5"-47" (1054mm-1194mm)
- D: 28.5"(724mm)
- W: 29"(737mm)
- *SW: 19.9"(505mm)
- *SD: 15.5"-18.5" (394mm-470mm)

* All measurements taken with the BIFMA chair measuring device.

Features

- Back: Flexible back with built in fronds wrapped in lofted mesh, knit or faux leather.
- Seat: Flexible seat pan with standard upholstered foam.
- Standard fixed seat. Optional seat depth adjustment (3"(76mm) range).
- Base: Plastic five-star base. Available in Black or Fog.
- Optional height adjustable lumbar support (4"(102mm) adjustment).
- Optional headrest has an upholstered front with a plastic back. Headrest material and trim color are matched to the back.
- Mechanism: Synchronized 3-point tilt; standard tilt tension adjustment.
- Height Adjustment: Pneumatic. Range: 16.5"-21.5"(419mm-546mm).
- Back Stop: 5 positions.
- Optional Forward Tilt (with Back Stop): 5° downward from initial position.
- Casters: Hard casters in black or two-tone grey; Soft casters black only.
- COM yardage / COL square footage: (Seat only) 0.71/8

To Order, Specify:

- 1) Product number, including;

1) Caster Option:

- 5 Hard Casters (Black)
- 6 Soft Casters (Black), add \$45.00 to list
- 7 Hard Two-Tone Casters (Grey)

- 2) Fabric surface and color (seat).
- 3) Mesh, knit or faux leather color (back).
- 4) Plastic trim color (back frame/cradle/base).
- 5) Aluminum trim color (back upright and mechanism). (Add \$105.33 list for polished aluminum back upright and mechanism.)

Specification Tip

- When Polished Aluminum trim is specified, lumbar handle will default to Polished Aluminum.

Description	Number	1	Fabric Grade								Leather Grade A	Leather Grade B
			A	B	C	D	E	F	G	H		
Mesh Back, No Lumbar Adjustment												
Back Stop w/Seat Depth Adjustment	SFT-UO-0N01A		\$1240.66	\$1280.45	\$1322.59	\$1343.65	\$1358.87	\$1396.33	\$1431.44	\$1523.89	\$1589.44	\$1755.64
Back Stop Forward Tilt w/Seat Depth Adjustment	SFT-UO-0N04A		1334.29	1374.08	1416.22	1437.28	1452.50	1489.96	1525.07	1617.52	1683.07	1849.27
Knit Back, No Lumbar Adjustment												
Back Stop w/Seat Depth Adjustment	SFT-UU-0N01A		\$1427.86	\$1467.65	\$1509.79	\$1530.85	\$1546.07	\$1583.53	\$1618.64	\$1711.09	\$1776.64	\$1942.84
Back Stop Forward Tilt w/Seat Depth Adjustment	SFT-UU-0N04A		1521.49	1561.28	1603.42	1624.48	1639.70	1677.16	1712.27	1804.72	1870.27	2036.47
Mesh Back, Lumbar Adjustment												
Back Stop w/Seat Depth Adjustment	SFT-UO-0N11A		\$1345.99	\$1385.78	\$1427.92	\$1448.98	\$1464.20	\$1501.66	\$1536.77	\$1629.22	\$1694.77	\$1860.97
Back Stop Forward Tilt w/Seat Depth Adjustment	SFT-UO-0N14A		1439.62	1479.41	1521.55	1542.61	1557.83	1595.29	1630.40	1722.85	1788.40	1954.60
Knit Back, Lumbar Adjustment												
Back Stop w/Seat Depth Adjustment	SFT-UU-0N11A		\$1533.19	\$1572.98	\$1615.12	\$1636.18	\$1651.40	\$1688.86	\$1723.97	\$1816.42	\$1881.97	\$2048.17
Back Stop Forward Tilt w/Seat Depth Adjustment	SFT-UU-0N14A		1626.82	1666.61	1708.75	1729.81	1745.03	1782.49	1817.60	1910.05	1975.60	2141.80

The following options require modification of the product number.

- Fixed seat To specify, change the 10th digit from an **A** to **F**; **Example:** SFT-UO-0N01F5
- Faux Leather back To specify, change the fifth digit in the product number to **U**; **Example:** SFT-UU-0N01A5 (Wellington; add \$134.60 list, Brisa; add \$347.62 list)
- Headrest To specify, change the third digit from a **T** to an **E**; **Example:** SFE-UO-0N01A5 (Mesh; add \$157.56 list, Faux Leather; add \$204.37 list)
- Stain repellent (Seat only) To specify, add **P** to the end of the product number and add \$40.97 list; **Example:** SFT-UO-0N01A5P

Fern

Task Chair without Arms — Aluminum Base Model

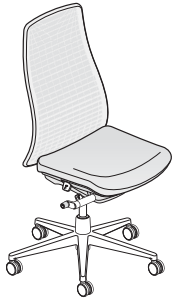

SFT-U0-0N01A

Dimensions

- *SH: 16.5"-21.5"
(419mm-546mm)
- H: 41.5"-47"
(1054mm-1194mm)
- D: 28.5"(724mm)
- W: 29"(737mm)
- *SW: 19.9"(505mm)
- *SD: 15.5"-18.5"
(394mm-470mm)

Low position seat height:
15"-17.5"(381mm-445mm)

* All measurements taken with the BIFMA chair measuring device.

Features

- Back: Flexible back with built in fronds wrapped in lofted mesh, knit or faux leather.
- Seat: Flexible seat pan with standard upholstered foam.
- Standard fixed seat. Optional seat depth adjustment (3"(76mm) range).
- Base: Aluminum five-star base.
- Optional height adjustable lumbar support (4"(102mm) adjustment).
- Optional headrest has an upholstered front with a plastic back. Headrest material and trim color are matched to the back.
- Mechanism: Synchronized 3-point tilt; standard tilt tension adjustment.
- Height Adjustment: Pneumatic or optional low position. Range: 15"-17.5"(381mm-445mm).
- Back Stop: 5 positions.
- Optional Forward Tilt (with Back Stop): 5° downward from initial position.
- Casters: Hard casters in black or two-tone grey; Soft casters black only.
- COM yardage / COL square footage: (Seat only) 0.71/8

Specification Tip

- When Polished Aluminum trim is specified, lumbar handle will default to Polished Aluminum.

To Order, Specify:

1) Product number, including;

1 Caster Option: Standard Base

- 1** Std. Base Hard Casters (Black)
- 2** Std. Base Soft Casters (Black), add **\$45.00** to list
- T** Std. Base Hard Two-Tone Casters (Grey)

Low Base

- 3** Low Base, Hard Casters (Black)
- 4** Low Base, Soft Casters (Black), add **\$45.00** to list

- 2) Fabric surface and color (seat).
- 3) Mesh, knit or faux leather color (back).
- 4) Plastic trim color (back frame/cradle). (Add **\$64.37** list for Snow TR-UFM for back frame/cradle.)
- 5) Aluminum trim color (back upright/mechanism/base). (Add **\$105.33** list for polished aluminum back upright and mechanism.)

1st Trim Color (Plastic)	Levers	Lumbar Handle
TR-F Black	TR-F Black	TR-TF Pitch
TR-7 Fog	TR-7 Fog	TR-AR Argent
TR-UFM Snow	TR-7 Fog	TR-FS Snowfall
TR-UFM Snow w/2nd trim PM-P Polished Aluminum	TR-7 Fog	PM-P Polished Aluminum

Description	Number	Fabric Grade								Leather Grade A	Leather Grade B
		A	B	C	D	E	F	G	H		
Mesh Back, No Lumbar Adjustment											
Back Stop w/Seat Depth Adjustment	SFT-U0-0N01A	\$1418.56	\$1458.35	\$1500.49	\$1521.55	\$1536.77	\$1574.23	\$1609.34	\$1701.79	\$1767.34	\$1933.54
Back Stop Forward Tilt w/Seat Depth Adjustment	SFT-U0-0N04A	1512.19	1551.98	1594.12	1615.18	1630.40	1667.86	1702.97	1795.42	1860.97	2027.17
Knit Back, No Lumbar Adjustment											
Back Stop w/Seat Depth Adjustment	SFT-UU-0N01A	\$1605.76	\$1645.55	\$1687.69	\$1708.75	\$1723.97	\$1761.43	41796.54	\$1888.99	\$1954.54	\$2120.74
Back Stop Forward Tilt w/Seat Depth Adjustment	SFT-UU-0N04A	1699.39	1739.18	1781.32	1802.38	1817.60	1855.06	1890.17	1982.62	2048.17	2214.37
Mesh Back, Lumbar Adjustment											
Back Stop w/Seat Depth Adjustment	SFT-U0-0N11A	\$1523.89	\$1563.68	\$1605.82	\$1626.88	\$1642.10	\$1679.56	\$1714.67	\$1807.12	\$1872.67	\$2038.87
Back Stop Forward Tilt w/Seat Depth Adjustment	SFT-U0-0N14A	1617.52	1657.31	1699.45	1720.51	1735.73	1773.19	1808.30	1900.75	1966.30	2132.50
Knit Back, Lumbar Adjustment											
Back Stop w/Seat Depth Adjustment	SFT-UU-0N11A	\$1711.09	\$1750.88	\$1793.02	\$1814.08	\$1829.30	\$1866.76	\$1901.87	\$1994.32	\$2059.87	\$2226.07
Back Stop Forward Tilt w/Seat Depth Adjustment	SFT-UU-0N14A	1804.72	1844.51	1886.65	1907.71	1922.93	1960.39	1995.50	2087.95	2153.50	2319.70

The following options require modification of the product number.

- Fixed seat To specify, change the 10th digit from an **A** to **F**; **Example:** SFT-U0-0N01F1
- Faux Leather back To specify, change the fifth digit in the product number to **U**; **Example:** SFT-UU-0N01A1 (Wellington; add **\$134.60** list, Brisa; add **\$347.62** list)
- Headrest To specify, change the third digit from a **T** to an **E**; **Example:** SFE-U0-0N01A1 (Mesh; add **\$157.56** list, Faux Leather; add **\$204.37** list)
- Stain repellent (Seat only) To specify, add **P** to the end of the product number and add **\$40.97** list; **Example:** SFT-U0-0N01A1P

Fern

Task Stool with 4D Arms — Plastic Base Model



SFS-U0-7501A

1st Trim Color (Plastic)	Arm Cap/Levers	Lumbar Handle
TR-F Black	TR-F Black	TR-TF Pitch
TR-7 Fog	TR-7 Fog	TR-AR Argent

Dimensions

- *SH: 21.75"-29.25"
(552mm-743mm)
- H: 46.75"-54.75"
(1187mm-1391mm)
- D: 28.5"(724mm)
- W: 29"(737mm)
- *SW: 19.9"(505mm)
- *AH: 6.7"-11.5"
(170mm-292mm)
- *SD: 15.5"-18.5"
(394mm-470mm)

* All measurements taken with the BIFMA chair measuring device.

Features

- Back: Flexible back with built in fronds wrapped in lofted mesh, knit or faux leather.
- Seat: Flexible seat pan with standard upholstered foam.
- Standard fixed seat. Optional seat depth adjustment (3"(76mm) range).
- Optional height adjustable lumbar support (4"(102mm) adjustment).
- Arms: 4D arms with plastic upright.
 - Move fore, aft, side to side and pivot in and out.
 - Height adjustment range of 4.8"(122mm).
- Arm Caps: Standard with soft arm caps.
- Mechanism: Synchronized 3-point tilt; standard tilt tension adjustment.
- Height Adjustment: Pneumatic. Range: 21.75"-29.25"(552mm-743mm).
- Back Stop: 5 positions.
- Base: Plastic five-star base.
- Footring: Adjusts 1.5"(38mm) up and down. Brushed aluminum finish.
- Casters: Hard casters in black or two-tone grey; Soft casters black only.
- COM yardage / COL square footage: (Seat only) 0.71/8

To Order, Specify:

- 1) Product number, including;
 - 1** **Caster Option:**
 - 5** Hard Casters (Black)
 - 6** Soft Casters (Black), add **\$45.00** to list
 - 7** Hard Two-Tone Casters (Grey)
- 2) Fabric surface and color (seat).
- 3) Mesh, knit or faux leather color (back).
- 4) Plastic trim color for back frame/cradle/arm uprights/base.
- 5) Aluminum trim color for back upright and mechanism. (Add **\$105.33** list for polished aluminum back upright and mechanism.)

Specification Tip

- When Polished Aluminum trim is specified, lumbar handle will default to Polished Aluminum.

Description	Number	①	Fabric Grade							Leather Grade A	Leather Grade B	
			A	B	C	D	E	F	G			H
Mesh Back, No Lumbar Adjustment												
Back Stop w/Seat Depth Adjustment	SFS-U0-7501A	■	\$1898.43	\$1938.22	\$1980.36	\$2001.42	\$2016.64	\$2054.10	\$2089.21	\$2181.66	\$2247.21	\$2413.41
Knit Back, No Lumbar Adjustment												
Back Stop w/Seat Depth Adjustment	SFS-UU-7501A	■	\$2085.63	\$2125.42	\$2167.56	\$2188.62	\$2203.84	\$2241.30	\$2276.41	\$2368.86	\$2434.41	\$2600.61
Mesh Back, Lumbar Adjustment												
Back Stop w/Seat Depth Adjustment	SFS-U0-7511A	■	\$2003.76	\$2043.55	\$2085.69	\$2106.75	\$2121.97	\$2159.43	\$2194.54	\$2286.99	\$2352.54	\$2518.74
Knit Back, Lumbar Adjustment												
Back Stop w/Seat Depth Adjustment	SFS-UU-7511A	■	\$2190.96	\$2230.75	\$2272.89	\$2293.95	\$2309.17	\$2346.63	\$2381.74	\$2474.19	\$2539.74	\$2705.94

The following options require modification of the product number.

- | | |
|-----------------------------|--|
| Fixed seat | To specify, change the 10th digit from an A to F ; Example: SFS-U0-7501 F5 |
| Faux Leather back | To specify, change the fifth digit in the product number to U ; Example: SFS-UU-7501 A5 (Wellington; add \$134.60 list, Brisa; add \$347.62 list) |
| Stain repellent (Seat only) | To specify, add P to the end of the product number and add \$40.97 list; Example: SFS-U0-7501 A5P |

Fern

Task Stool with 4D Arms — Aluminum Base Model



SFS-U0-7S01A

Dimensions

- *SH: 21.75"-29.25"
(552mm-743mm)
- H: 46.75"-54.75"
(1187mm-1391mm)
- D: 28.5"(724mm)
- W: 29"(737mm)
- *SW: 19.9"(505mm)
- *AH: 6.7"-11.5"
(170mm-292mm)
- *SD: 15.5"-18.5"
(394mm-470mm)

* All measurements taken with the BIFMA chair measuring device.

Features

- Back: Flexible back with built in fronds wrapped in lofted mesh, knit or faux leather.
- Seat: Flexible seat pan with standard upholstered foam.
- Standard fixed seat. Optional seat depth adjustment (3"(76mm) range).
- Optional height adjustable lumbar support (4"(102mm) adjustment).
- Arms: 4D arms with aluminum upright.
–Move fore, aft, side to side and pivot in and out.
–Height adjustment range of 4.8"(122mm).
- Arm Caps: Standard with soft arm caps.
- Mechanism: Synchronized 3-point tilt; standard tilt tension adjustment.
- Height Adjustment: Pneumatic. Range: 21.75"-29.25"(552mm-743mm).
- Back Stop: 5 positions.
- Base: Aluminum five-star base.
- Footring: Adjusts 1.5"(38mm) up and down. Brushed aluminum finish.
- Casters: Hard casters in black or two-tone grey; Soft casters black only.
- COM yardage / COL square footage:
(Seat only) 0.71/8

To Order, Specify:

1) Product number, including;

1 Caster Option:

- 1** Hard Casters (Black)
- 2** Soft Casters (Black), add **\$45.00** to list
- T** Hard Two-Tone Casters (Grey)

- 2) Fabric surface and color (seat).
- 3) Mesh, knit or faux leather color (back).
- 4) Plastic trim color for back frame/cradle. (Add **\$64.37** list for Snow TR-UFM for back frame/cradle.)
- 5) Aluminum trim color for back and arm upright/mechanism/base. (Add **\$105.33** list for polished aluminum back upright and mechanism.)

1st Trim Color (Plastic)	Arm Cap/Levers	Lumbar Handle
TR-F Black	TR-F Black	TR-TF Pitch
TR-7 Fog	TR-7 Fog	TR-AR Argent
TR-UFM Snow	TR-7 Fog	TR-FS Snowfall
TR-UFM Snow w/2nd trim PM-P Polished Aluminum	TR-7 Fog	PM-P Polished Aluminum

Specification Tip

- When Polished Aluminum trim is specified, lumbar handle will default to Polished Aluminum.

Description	Number	1	Fabric Grade							Leather Grade A	Leather Grade B	
			A	B	C	D	E	F	G			H
Mesh Back, No Lumbar Adjustment												
Back Stop w/Seat Depth Adjustment	SFS-U0-7S01A		\$2076.33	\$2116.12	\$2158.26	\$2179.32	\$2194.54	\$2232.00	\$2267.11	\$2359.56	\$2425.11	\$2591.31
Knit Back, No Lumbar Adjustment												
Back Stop w/Seat Depth Adjustment	SFS-UU-7S01A		\$2263.53	\$2303.32	\$2345.46	\$2366.52	\$2381.74	\$2419.20	\$2454.31	\$2546.76	\$2612.31	\$2778.51
Mesh Back, Lumbar Adjustment												
Back Stop w/Seat Depth Adjustment	SFS-U0-7S11A		\$2181.66	\$2221.45	\$2263.59	\$2284.65	\$2299.87	\$2337.33	\$2372.44	\$2464.89	\$2530.44	\$2696.64
Knit Back, Lumbar Adjustment												
Back Stop w/Seat Depth Adjustment	SFS-UU-7S11A		\$2368.86	\$2408.65	\$2450.79	\$2471.85	\$2487.07	\$2524.53	\$2559.64	\$2652.09	\$2717.64	\$2883.84

The following options require modification of the product number.

- Fixed seat To specify, change the 10th digit from an **A** to **F**; **Example:** SFS-U0-7S01F1
- Faux Leather back To specify, change the fifth digit in the product number to **U**; **Example:** SFS-UU-7S01A1 (Wellington; add **\$134.60** list, Brisa; add **\$347.62** list)
- Stain repellent (Seat only) To specify, add **P** to the end of the product number and add **\$40.97** list; **Example:** SFS-U0-7S01A1P

Fern

Task Stool with Height Adjustable Arms — Plastic Base Model



SFS-U0-4S01A

1st Trim Color (Plastic)	Arm Cap/Levers	Lumbar Handle
TR-F Black	TR-F Black	TR-TF Pitch
TR-7 Fog	TR-7 Fog	TR-AR Argent

Dimensions

- *SH: 21.75"-29.25"
(552mm-743mm)
- H: 46.75"-54.75"
(1187mm-1391mm)
- D: 28.5"(724mm)
- W: 29"(737mm)
- *SW: 19.9"(505mm)
- *AH: 6.7"-11.5"
(170mm-292mm)
- *SD: 15.5"-18.5"
(394mm-470mm)

* All measurements taken with the BIFMA chair measuring device.

Features

- Back: Flexible back with built in fronds wrapped in lofted mesh, knit or faux leather.
- Seat: Flexible seat pan with standard upholstered foam.
- Standard fixed seat. Optional seat depth adjustment (3"(76mm) range).
- Base: Plastic five-star base.
- Optional height adjustable lumbar support (4"(102mm) adjustment).
- Arms: Height Adjustable with soft arm caps. Adjustment range of 4.8"(122mm).
- Mechanism: Synchronized 3-point tilt; standard tilt tension adjustment.
- Height Adjustment: Pneumatic. Range: 21.75"-29.25"(552mm-743mm).
- Back Stop: 5 positions.
- Footring: Adjusts 1.5"(38mm) up and down. Brushed aluminum finish.
- Casters: Hard casters in black or two-tone grey; Soft casters black only.
- COM yardage / COL square footage: (Seat only) 0.71/8

To Order, Specify:

- 1) Product number, including;
 - 1** **Caster Option:**
 - 5** Hard Casters (Black)
 - 6** Soft Casters (Black), add **\$45.00** to list
 - 7** Hard Two-Tone Casters (Grey)
- 2) Fabric surface and color (seat).
- 3) Mesh, knit or faux leather color (back).
- 4) Plastic trim color for back frame/cradle/arm uprights/base.
- 5) Aluminum trim color for back upright and mechanism.
(Add **\$105.33** list for polished aluminum back upright and mechanism.)

Specification Tip

- When Polished Aluminum trim is specified, lumbar handle will default to Polished Aluminum.

Description	Number	①	Fabric Grade							Leather Grade A	Leather Grade B	
			A	B	C	D	E	F	G			H
Mesh Back, No Lumbar Adjustment												
Back Stop w/Seat Depth Adjustment	SFS-U0-4S01A	■	\$1869.19	\$1908.98	\$1951.12	\$1972.18	\$1987.40	\$2024.86	\$2059.97	\$2152.42	\$2217.97	\$2384.17
Knit Back, No Lumbar Adjustment												
Back Stop w/Seat Depth Adjustment	SFS-UU-4S01A	■	\$2056.39	\$2096.18	\$2138.32	\$2159.38	\$2174.60	\$2212.06	\$2247.17	\$2339.62	\$2405.17	\$2571.37
Mesh Back, Lumbar Adjustment												
Back Stop w/Seat Depth Adjustment	SFS-U0-4S11A	■	\$1974.52	\$2014.31	\$2056.45	\$2077.51	\$2092.73	\$2130.19	\$2165.30	\$2257.75	\$2323.30	\$2489.50
Knit Back, Lumbar Adjustment												
Back Stop w/Seat Depth Adjustment	SFS-UU-4S11A	■	\$2161.72	\$2201.51	\$2243.65	\$2264.71	\$2279.93	\$2317.39	\$2352.50	\$2444.95	\$2510.50	\$2676.70

The following options require modification of the product number.

- Fixed seat To specify, change the 10th digit from an **A** to **F**; **Example:** SFS-U0-4S01**F5**
- Faux Leather back To specify, change the fifth digit in the product number to **U**; **Example:** SFS-UU-4S01**A5** (Wellington; add **\$134.60** list, Brisa; add **\$347.62** list)
- Stain repellent (Seat only) To specify, add **P** to the end of the product number and add **\$40.97** list; **Example:** SFS-U0-4S01**A5P**

Fern

Task Stool with Height Adjustable Arms — Aluminum Base Model



SFS-U0-4S01A

Dimensions

- *SH: 21.75"-29.25"
(552mm-743mm)
- H: 46.75"-54.75"
(1187mm-1391mm)
- D: 28.5"(724mm)
- W: 29"(737mm)
- *SW: 19.9"(505mm)
- *AH: 6.7"-11.5"
(170mm-292mm)
- *SD: 15.5"-18.5"
(394mm-470mm)

* All measurements taken with the BIFMA chair measuring device.

Features

- Back: Flexible back with built in fronds wrapped in lofted mesh, knit or faux leather.
- Seat: Flexible seat pan with standard upholstered foam.
- Standard fixed seat. Optional seat depth adjustment (3"(76mm) range).
- Optional height adjustable lumbar support (4"(102mm) adjustment).
- Arms: Height Adjustable with soft arm caps. Adjustment range of 4.8"(122mm).
- Mechanism: Synchronized 3-point tilt; standard tilt tension adjustment.
- Height Adjustment: Pneumatic. Range: 21.75"-29.25"(552mm-743mm).
- Back Stop: 5 positions.
- Base: Aluminum five-star base.
- Footring: Adjusts 1.5"(38mm) up and down. Brushed aluminum finish.
- Casters: Hard casters in black or two-tone grey; Soft casters black only.
- COM yardage / COL square footage: (Seat only) 0.71/8

To Order, Specify:

1) Product number, including;

1 Caster Option:

- 1** Hard Casters (Black)
- 2** Soft Casters (Black), add **\$45.00** to list
- T** Hard Two-Tone Casters (Grey)

- 2) Fabric surface and color (seat).
- 3) Mesh, knit or faux leather color (back).
- 4) Plastic trim color for back frame/cradle. (Add **\$64.37** list for Snow TR-UFM for back frame/cradle.)
- 5) Aluminum trim color for back and arm upright/mechanism/base. (Add **\$105.33** list for polished aluminum back upright and mechanism.)

1st Trim Color (Plastic)	Arm Cap/Levers	Lumbar Handle
TR-F Black	TR-F Black	TR-TF Pitch
TR-7 Fog	TR-7 Fog	TR-AR Argent
TR-UFM Snow	TR-7 Fog	TR-FS Snowfall
TR-UFM Snow w/2nd trim PM-P Polished Aluminum	TR-7 Fog	PM-P Polished Aluminum

Specification Tip

- When Polished Aluminum trim is specified, lumbar handle will default to Polished Aluminum.

Description	Number	1	Fabric Grade							Leather Grade A	Leather Grade B	
			A	B	C	D	E	F	G			H
Mesh Back, No Lumbar Adjustment												
Back Stop w/Seat Depth Adjustment	SFS-U0-4S01A		\$2047.09	\$2086.88	\$2129.02	\$2150.08	\$2165.30	\$2202.76	\$2237.87	\$2330.32	\$2395.87	\$2562.07
Knit Back, No Lumbar Adjustment												
Back Stop w/Seat Depth Adjustment	SFS-UU-4S01A		\$2234.29	\$2274.08	\$2316.22	\$2337.28	\$2352.50	\$2389.96	\$2425.07	\$2517.52	\$2583.07	\$2749.27
Mesh Back, Lumbar Adjustment												
Back Stop w/Seat Depth Adjustment	SFS-U0-4S11A		\$2152.42	\$2192.21	\$2234.35	\$2255.41	\$2270.63	\$2308.09	\$2343.20	\$2435.65	\$2501.20	\$2667.40
Knit Back, Lumbar Adjustment												
Back Stop w/Seat Depth Adjustment	SFS-UU-4S11A		\$2339.62	\$2379.41	\$2421.55	\$2442.61	\$2457.83	\$2495.29	\$2530.40	\$2622.85	\$2688.40	\$2854.60

The following options require modification of the product number.

- Fixed seat To specify, change the 10th digit from an **A** to **F**; **Example:** SFS-U0-4S01F1
- Faux Leather back To specify, change the fifth digit in the product number to **U**; **Example:** SFS-UU-4S01A1 (Wellington; add **\$134.60** list, Brisa; add **\$347.62** list)
- Stain repellent (Seat only) To specify, add **P** to the end of the product number and add **\$40.97** list; **Example:** SFS-U0-4S01A1P

Fern

Task Stool with Fixed Arms — Plastic Base Model



SFS-U0-1S0A

1st Trim Color (Plastic)	Arm Cap/Levers	Lumbar Handle
TR-F Black	TR-F Black	TR-TF Pitch
TR-7 Fog	TR-7 Fog	TR-AR Argent

Dimensions

- *SH: 21.75"-29.25"
(552mm-743mm)
- H: 46.75"-54.75"
(1187mm-1391mm)
- D: 28.5"(724mm)
- W: 29"(737mm)
- *SW: 19.9"(505mm)
- *AH: 9"(229mm)
- *SD: 15.5"-18.5"
(394mm-470mm)

* All measurements taken with the BIFMA chair measuring device.

Features

- Back: Flexible back with built in fronds wrapped in lofted mesh, knit or faux leather.
- Seat: Flexible seat pan with standard upholstered foam.
- Standard fixed seat. Optional seat depth adjustment (3"(76mm) range).
- Optional height adjustable lumbar support (4"(102mm) adjustment).
- Arms: Fixed aluminum arms with soft arm caps.
- Optional leather arm cap available when ordering a leather seat. Leather arm cap coordinates with leather seat selection.
- Mechanism: Synchronized 3-point tilt; standard tilt tension adjustment.
- Height Adjustment: Pneumatic. Range: 21.75"-29.25"(552mm-743mm).
- Back Stop: 5 positions.
- Base: Plastic five-star base.
- Footring: Adjusts 1.5"(38mm) up and down. Brushed aluminum finish.
- Casters: Hard casters in black or two-tone grey; Soft casters black only.
- COM yardage / COL square footage: (Seat only) 0.71/8

To Order, Specify:

- 1) Product number, including;
 - 1** **Caster Option:**
 - 5** Hard Casters (Black)
 - 6** Soft Casters (Black), add **\$45.00** to list
 - 7** Hard Two-Tone Casters (Grey)
- 2) Fabric surface and color (seat).
- 3) Mesh, knit or faux leather color (back).
- 4) Plastic trim color for back frame/cradle/base.
- 5) Aluminum trim color for back and arm upright/mechanism. (Add **\$105.33** list for polished aluminum back upright and mechanism.)

Specification Tip

- When Polished Aluminum trim is specified, lumbar handle will default to Polished Aluminum.

Description	Number	①	Fabric Grade								Leather Grade A	Leather Grade B
			A	B	C	D	E	F	G	H		
Mesh Back, No Lumbar Adjustment												
Back Stop w/Seat Depth Adjustment	SFS-U0-1S01A	■	\$1851.62	\$1891.41	\$1933.55	\$1954.61	\$1969.83	\$2007.29	\$2042.40	\$2134.85	\$2200.40	\$2366.60
Knit Back, No Lumbar Adjustment												
Back Stop w/Seat Depth Adjustment	SFS-UU-1S01A	■	\$2038.82	\$2078.61	\$2120.75	\$2141.81	\$2157.03	\$2194.49	\$2229.60	\$2322.05	\$2387.60	\$2553.80
Mesh Back, Lumbar Adjustment												
Back Stop w/Seat Depth Adjustment	SFS-U0-1S11A	■	\$1956.95	\$1996.74	\$2038.88	\$2059.94	\$2075.16	\$2112.62	\$2147.73	\$2240.18	\$2305.73	\$2471.93
Knit Back, Lumbar Adjustment												
Back Stop w/Seat Depth Adjustment	SFS-UU-1S11A	■	\$2144.15	\$2183.94	\$2226.08	\$2247.14	\$2262.36	\$2299.82	\$2334.93	\$2427.38	\$2492.93	\$2659.13

The following options require modification of the product number.

- | | |
|-----------------------------|--|
| Fixed seat | To specify, change the 10th digit from an A to F ; Example: SFS-U0-1S01 F5 |
| Leather arm cap | To specify, change the 7th digit from S to L ; Example: SFS-U0-1 L 01A5 (matches required Leather seat), add \$81.93 list |
| Faux Leather back | To specify, change the fifth digit in the product number to U ; Example: SFS-UU-1S01A5 (Wellington; add \$134.60 list, Brisa; add \$347.62 list) |
| Stain repellent (Seat only) | To specify, add P to the end of the product number and add \$40.97 list; Example: SFS-U0-1S01A5 P |

Fern

Task Stool with Fixed Arms — Aluminum Base Model



SFS-U0-1S01A

Dimensions

- *SH: 21.75"-29.25"
(552mm-743mm)
- H: 46.75"-54.75"
(1187mm-1391mm)
- D: 28.5"(724mm)
- W: 29"(737mm)
- *SW: 19.9"(505mm)
- *AH: 9"(229mm)
- *SD: 15.5"-18.5"
(394mm-470mm)

* All measurements taken with the BIFMA chair measuring device.

Features

- Back: Flexible back with built in fronds wrapped in lofted mesh, knit or faux leather.
- Seat: Flexible seat pan with standard upholstered foam.
- Standard fixed seat. Optional seat depth adjustment (3"(76mm) range).
- Optional height adjustable lumbar support (4"(102mm) adjustment).
- Arms: Fixed with soft arm caps.
- Optional leather arm cap available when ordering a leather seat. Leather arm cap coordinates with leather seat selection.
- Mechanism: Synchronized 3-point tilt; standard tilt tension adjustment.
- Height Adjustment: Pneumatic. Range: 21.75"-29.25"(552mm-743mm).
- Back Stop: 5 positions.
- Base: Aluminum five-star base.
- Footring: Adjusts 1.5"(38mm) up and down. Brushed aluminum finish.
- Casters: Hard casters in black or two-tone grey; Soft casters black only.
- COM yardage / COL square footage: (Seat only) 0.71/8

To Order, Specify:

1) Product number, including;

1 Caster Option:

- 1** Hard Casters (Black)
- 2** Soft Casters (Black), add **\$45.00** to list
- T** Hard Two-Tone Casters (Grey)

- 2) Fabric surface and color (seat).
- 3) Mesh, knit or faux leather color (back).
- 4) Plastic trim color for base frame/cradle. (Add **\$64.37** list for Snow TR-UFM for back frame/cradle.)
- 5) Aluminum trim color for back and arm upright/mechanism/base. (Add **\$105.33** list for polished aluminum back upright and mechanism.)

1st Trim Color (Plastic)	Arm Cap/Levers	Lumbar Handle
TR-F Black	TR-F Black	TR-TF Pitch
TR-7 Fog	TR-7 Fog	TR-AR Argent
TR-UFM Snow	TR-7 Fog	TR-FS Snowfall
TR-UFM Snow w/2nd trim PM-P Polished Aluminum	TR-7 Fog	PM-P Polished Aluminum

Specification Tip

- When Polished Aluminum trim is specified, lumbar handle will default to Polished Aluminum.

Description	Number	1	Fabric Grade								Leather Grade A	Leather Grade B
			A	B	C	D	E	F	G	H		
Mesh Back, No Lumbar Adjustment												
Back Stop w/Seat Depth Adjustment	SFS-U0-1S01A		\$2029.52	\$2069.31	\$2111.45	\$2132.51	\$2147.73	\$2185.19	\$2220.30	\$2312.75	\$2378.30	\$2544.50
Knit Back, No Lumbar Adjustment												
Back Stop w/Seat Depth Adjustment	SFS-UU-1S01A		\$2216.72	\$2256.51	\$2298.65	\$2319.71	\$2334.93	\$2372.39	\$2407.50	\$2499.95	\$2565.50	\$2731.70
Mesh Back, Lumbar Adjustment												
Back Stop w/Seat Depth Adjustment	SFS-U0-1S11A		\$2134.85	\$2174.64	\$2216.78	\$2237.84	\$2253.06	\$2290.52	\$2325.63	\$2418.08	\$2483.63	\$2649.83
Knit Back, Lumbar Adjustment												
Back Stop w/Seat Depth Adjustment	SFS-UU-1S11A		\$2322.05	\$2361.84	\$2403.98	\$2425.04	\$2440.26	\$2477.72	\$2512.83	\$2605.28	\$2670.83	\$2837.03

The following options require modification of the product number.

- Fixed seat To specify, change the 10th digit from an **A** to **F**; **Example:** SFS-U0-1S01F1
- Leather arm cap To specify, change the 7th digit from **S** to **L**; **Example:** SFS-U0-1L01A1 (matches required Leather seat), add **\$81.93** list
- Faux Leather back To specify, change the fifth digit in the product number to **U**; **Example:** SFS-UU-1S01A1 (Wellington; add **\$134.60** list, Brisa; add **\$347.62** list)
- Stain repellent (Seat only) To specify, add **P** to the end of the product number and add **\$40.97** list; **Example:** SFS-U0-1S01A1P

Fern

Task Stool without Arms — Plastic Base Model



SFS-U0-0N01A

Dimensions

- *SH: 21.75"-29.25"
(552mm-743mm)
- H: 46.75"-54.75"
(1187mm-1391mm)
- D: 28.5"(724mm)
- W: 29"(737mm)
- *SW: 19.9"(505mm)
- *SD: 15.5"-18.5"
(394mm-470mm)

* All measurements taken with the BIFMA chair measuring device.

Features

- Back: Flexible back with built in fronds wrapped in lofted mesh, knit or faux leather.
- Seat: Flexible seat pan with standard upholstered foam.
- Standard fixed seat. Optional seat depth adjustment (3"(76mm) range).
- Optional height adjustable lumbar support (4"(102mm) adjustment).
- Mechanism: Synchronized 3-point tilt; standard tilt tension adjustment.
- Height Adjustment: Pneumatic. Range: 21.75"-29.25"(552mm-743mm).
- Back Stop: 5 positions.
- Footring: Adjusts 1.5"(38mm) up and down. Brushed aluminum finish.
- Casters: Hard casters in black or two-tone grey; Soft casters black only.
- COM yardage / COL square footage: (Seat only) 0.71/8

To Order, Specify:

- 1) Product number, including;
 - 1** **Caster Option:**
 - 5** Hard Casters (Black)
 - 6** Soft Casters (Black), add **\$45.00** to list
 - 7** Hard Two-Tone Casters (Grey)
- 2) Fabric surface and color (seat).
- 3) Mesh, knit or faux leather color (back).
- 4) Plastic trim color for back frame/cradle/base.
- 5) Aluminum trim color for back upright and mechanism. (Add **\$105.33** list for polished aluminum back upright and mechanism.)

1st Trim Color (Plastic)	Levers	Lumbar Handle
TR-F Black	TR-F Black	TR-TF Pitch
TR-7 Fog	TR-7 Fog	TR-AR Argent

Specification Tip

- When Polished Aluminum trim is specified, lumbar handle will default to Polished Aluminum.

Description	Number	1	Fabric Grade								Leather Grade A	Leather Grade B
			A	B	C	D	E	F	G	H		
Mesh Back, No Lumbar Adjustment												
Back Stop w/Seat Depth Adjustment	SFS-U0-0N01A		\$1711.17	\$1750.96	\$1793.10	\$1814.16	\$1829.38	\$1866.84	\$1901.95	\$1994.40	\$2059.95	\$2226.15
Knit Back, No Lumbar Adjustment												
Back Stop w/Seat Depth Adjustment	SFS-UU-0N01A		\$1898.37	\$1938.16	\$1980.30	\$2001.36	\$2016.58	\$2054.04	\$2089.15	\$2181.60	\$2247.15	\$2413.35
Mesh Back, Lumbar Adjustment												
Back Stop w/Seat Depth Adjustment	SFS-U0-0N11A		\$1816.50	\$1856.29	\$1898.43	\$1919.49	\$1934.71	\$1972.17	\$2007.28	\$2099.73	\$2165.28	\$2331.48
Knit Back, Lumbar Adjustment												
Back Stop w/Seat Depth Adjustment	SFS-UU-0N11A		\$2003.70	\$2043.49	\$2085.63	\$2106.69	\$2121.91	\$2159.37	\$2194.48	\$2286.93	\$2352.48	\$2518.68

The following options require modification of the product number.

- | | |
|-----------------------------|--|
| Fixed seat | To specify, change the 10th digit from an A to F ; Example: SFS-U0-0N01 F5 |
| Faux Leather back | To specify, change the fifth digit in the product number to U ; Example: SFS-UU-0N01 A5 (Wellington; add \$134.60 list, Brisa; add \$347.62 list) |
| Stain repellent (Seat only) | To specify, add P to the end of the product number and add \$40.97 list; Example: SFS-U0-0N01 A5P |

Fern

Task Stool without Arms — Aluminum Base Model



SFS-U0-0N01A

Dimensions

- *SH: 21.75"-29.25"
(552mm-743mm)
- H: 46.75"-54.75"
(1187mm-1391mm)
- D: 28.5"(724mm)
- W: 29"(737mm)
- *SW: 19.9"(505mm)
- *SD: 15.5"-18.5"
(394mm-470mm)

* All measurements taken with the BIFMA chair measuring device.

Features

- Back: Flexible back with built in fronds wrapped in lofted mesh, knit or faux leather.
- Seat: Flexible seat pan with standard upholstered foam.
- Standard fixed seat. Optional seat depth adjustment (3"(76mm) range).
- Optional height adjustable lumbar support (4"(102mm) adjustment).
- Mechanism: Synchronized 3-point tilt; standard tilt tension adjustment.
- Height Adjustment: Pneumatic. Range: 21.75"-29.25"(552mm-743mm).
- Back Stop: 5 positions.
- Base: Aluminum five-star base.
- Footring: Adjusts 1.5"(38mm) up and down. Brushed aluminum finish.
- Casters: Hard casters in black or two-tone grey; Soft casters black only.
- COM yardage / COL square footage: (Seat only) 0.71/8

To Order, Specify:

1) Product number, including;

1 Caster Option:

- 1** Hard Casters (Black)
- 2** Soft Casters (Black), add **\$45.00** to list
- T** Hard Two-Tone Casters (Grey)

- 2) Fabric surface and color (seat).
- 3) Mesh, knit or faux leather color (back).
- 4) Plastic trim color for back frame/cradle. (Add **\$64.37** list for Snow TR-UFM for back frame/cradle.)
- 5) Aluminum trim color for back upright/mechanism/base. (Add **\$105.33** list for polished aluminum back upright and mechanism.)

1st Trim Color (Plastic)	Levers	Lumbar Handle
TR-F Black	TR-F Black	TR-TF Pitch
TR-7 Fog	TR-7 Fog	TR-AR Argent
TR-UFM Snow	TR-7 Fog	TR-FS Snowfall
TR-UFM Snow w/2nd trim PM-P Polished Aluminum	TR-7 Fog	PM-P Polished Aluminum

Specification Tip

- When Polished Aluminum trim is specified, lumbar handle will default to Polished Aluminum.

Description	Number	1	Fabric Grade								Leather Grade A	Leather Grade B
			A	B	C	D	E	F	G	H		
Mesh Back, No Lumbar Adjustment												
Back Stop w/Seat Depth Adjustment	SFS-U0-0N01A		\$1889.07	\$1928.86	\$1971.00	\$1992.06	\$2007.28	\$2044.74	\$2079.85	\$2172.30	\$2237.85	\$2404.05
Knit Back, No Lumbar Adjustment												
Back Stop w/Seat Depth Adjustment	SFS-UU-0N01A		\$2076.27	\$2116.06	\$2158.20	\$2179.26	\$2194.48	\$2231.94	\$2267.05	\$2359.50	\$2425.05	\$2591.25
Mesh Back, Lumbar Adjustment												
Back Stop w/Seat Depth Adjustment	SFS-U0-0N11A		\$1994.40	\$2034.19	\$2076.33	\$2097.39	\$2112.61	\$2150.07	\$2185.18	\$2277.63	\$2343.18	\$2509.38
Knit Back, Lumbar Adjustment												
Back Stop w/Seat Depth Adjustment	SFS-UU-0N11A		\$2181.60	\$2221.39	\$2263.53	\$2284.59	\$2299.81	\$2337.27	\$2372.38	\$2464.83	\$2530.38	\$2696.58

The following options require modification of the product number.

- Fixed seat To specify, change the 10th digit from an **A** to **F**; **Example:** SFS-U0-0N01**F**1
- Faux Leather back To specify, change the fifth digit in the product number to **U**; **Example:** SFS-UU-0N01**A**1 (Wellington; add **\$134.60** list, Brisa; add **\$347.62** list)
- Stain repellent (Seat only) To specify, add **P** to the end of the product number and add **\$40.97** list; **Example:** SFS-U0-0N01**A**1**P**

Zody-At-A-Glance

Designer	ITO Design and Haworth Design Studio
Awards/Achievements	NeoCon Silver, Best of NeoCon, Seating: Ergonomic Desk/Task, June 2005, USA IIDEX/NeoCon Gold, Seating: Desk/Workstation Chairs, September 2005, Canada BIFMA level 3 certified.
Zody	A high-performing chair that blends science-based wellness and comfort with sustainability and international design.

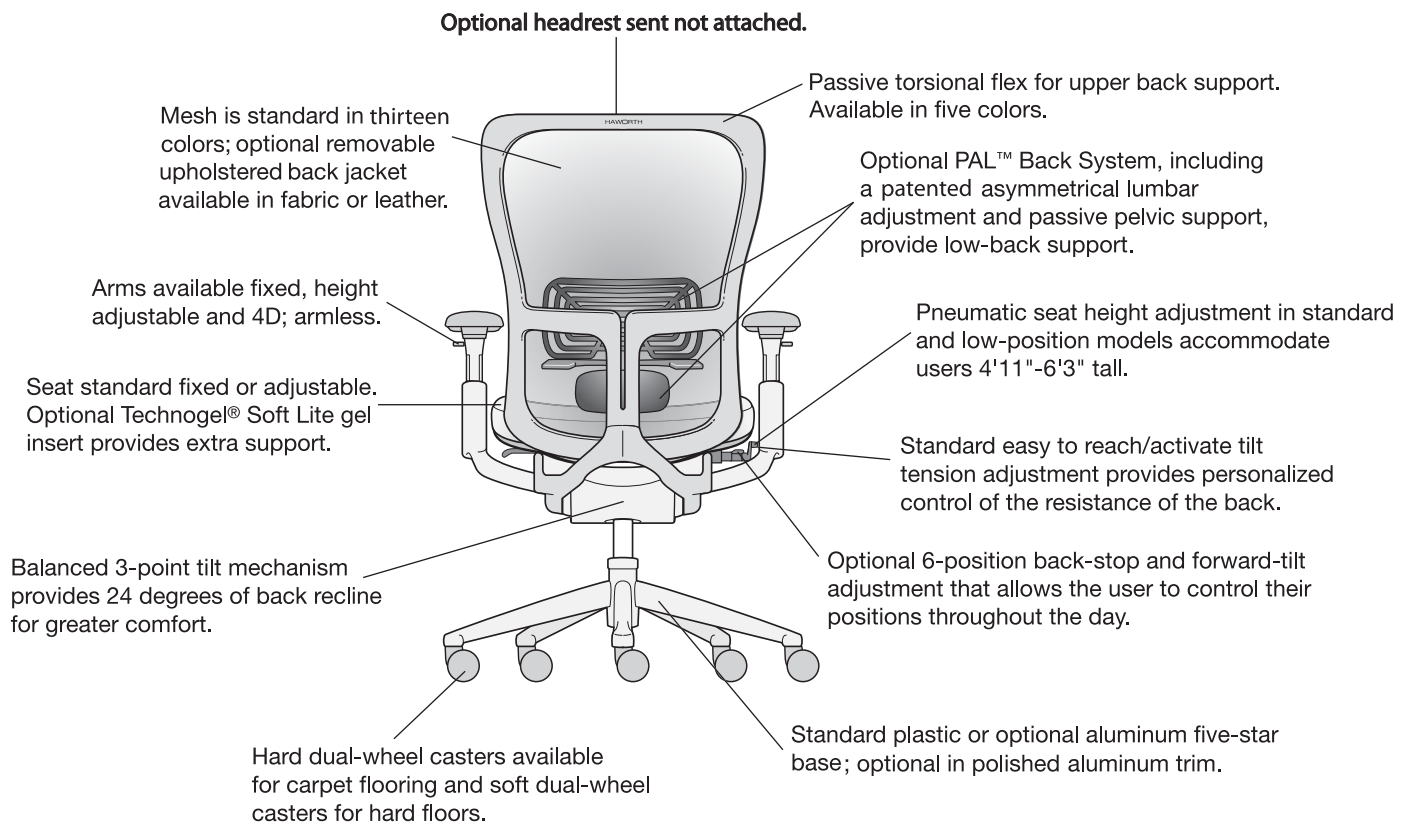

Note: Headrest and forward-tilt options not available on Stool.

Zody-At-A-Glance

General Specifications

General Guidelines for Product Specification

Zody seating specification numbers are based on an alpha-numeric logic that identifies a product by model and certain characteristics.

For example, a product number that reads **SZT-20-702MA5 3A-18 MA-001 TR-F TR-F** identifies the product as a Zody mesh back chair with 4D arms, no lumbar, pneumatic seat height adjustment, foam adjustable seat and standard plastic base TR-F black only with hard casters. The numeric logic for this model with fabric and finish codes is shown below:

Mesh Back

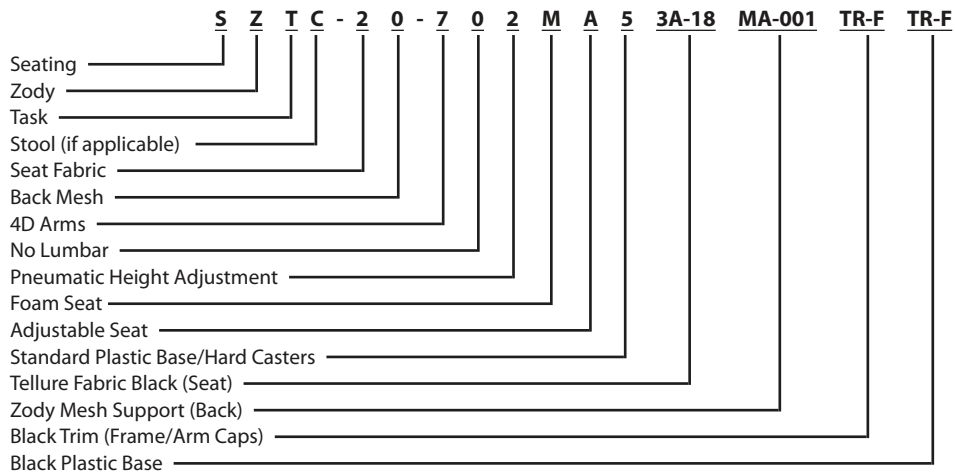

Mesh Back with Upholstered Back Jacket

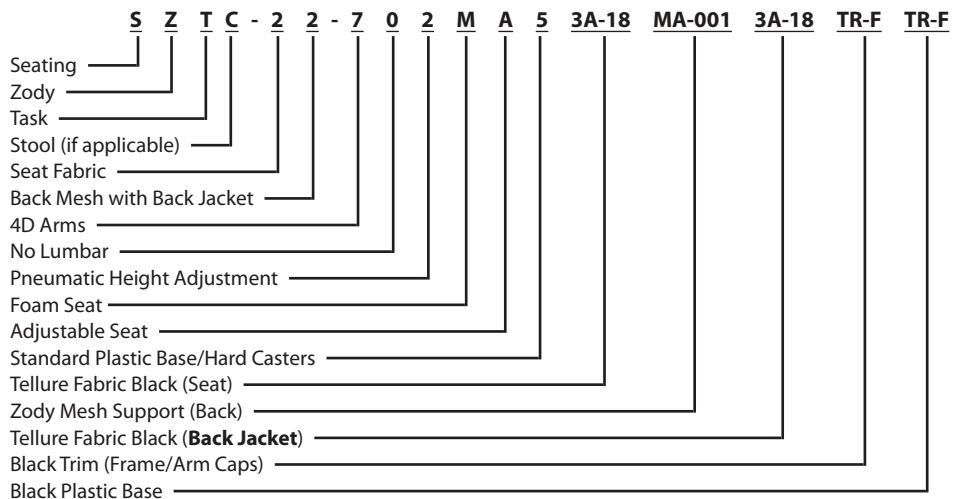

There are exceptions to this logic; therefore, always refer to the price charts for product numbers rather than attempting to construct them. Product number modification instructions for additional options appear in footnoted copy for each applicable model.

Beyond the printed product number, fabric and finish codes are required to complete an order specification. To communicate your order clearly, list the product number and fabric/finish codes in the sequence outlined on each price page.

Zody-At-A-Glance

General Specifications

Environmental Factors	<ul style="list-style-type: none"> • Zody has been evaluated for its human health, environmental health, lifecycle attributes, renewable energy, water stewardship and social responsibility characteristics against stringent certification criteria and is considered an ecologically intelligent product. • Refer to Product Environmental Data sheet (PED) for recycled content and certifications. • Zody is produced in an ISO 14001 certified manufacturing facility. • Components are identified with ISO recycling symbols and material information to assist in the recycling effort, where practical. • Haworth will take back Zody chairs after their useful life and recycle the components. Please contact Haworth's Material Recovery Center at (616)393-1215. • Optional Trivalent chrome finish provides safer and more environmentally friendly alternative for customers requiring the attributes of a chrome finish.
COM & COL General Information	<p>To order a COM fabric (Customer's Own Material), contact the Haworth Inquiry Center (1.800.426.8562), your local Haworth dealer, or go to surfaces.haworth.com to find out if the COM you have selected has already been tested and approved. The surface collection site also has information on the Haworth alliance program with Carnegie, Luna Textiles, and Maharam as well as our industry-leading Pre-Approved COM program.</p> <p>COM fabrics are placed into Grades based on the cost per linear yard. If a fabric's cost exceeds the range of our highest Grade it will be noted as Non-Graded. The product will be priced at Grade A; the COM fabric costs will appear as a separate line item. The fabric charge will be Haworth's purchase cost plus a 4% administrative fee (based on the cost of the fabric). Yardage calculations will include any applicable fabric repeat.</p> <p>COM Leather products will be priced at a leather Grade A; COL costs will appear as a separate line item. The leather costs will be Haworth's purchase cost plus a 4% administrative fee (based on the cost of the leather).</p>
Finishes and Fabrics	A complete listing of finishes and fabrics for Zody seating is available in the back of the price list.
Shipping Weights (Including packaging)	<ul style="list-style-type: none"> • Chairs with arms: 55 pounds/1 chair per carton/17.3 cubic feet • Chairs without arms: 51 pounds/1 chair per carton/17.3 cubic feet • Chairs with sled base: 24 pounds/1 chair per carton/17.3 cubic feet • Chairs with leg base: 21 pounds/1 chair per carton/17.3 cubic feet • Stool with arms: 58 pounds/1 stool per carton/21.5 cubic feet • Stool without arms: 54 pounds/1 stool per carton/21.5 cubic feet
Stain Repellent	<p>To specify add "P" to end of product number. Example: SZT-22-702MA1P</p> <p>Not available on mesh, faux leather, or leather. For available fabrics, refer to surfaces.haworth.com.</p>

Zody

General Specifications

STANDARD MOBILITY AND ADJUSTABILITY

Balanced 3-point tilt

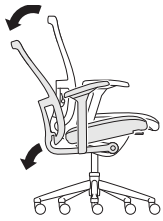

Features:

- Balanced 3-point tilt mechanism.
- Back reclines 24° from the upright position.
- Seat pan moves downward 3° from the initial position.

Benefits:

- Comfortable relaxed posture.
- Recline allows for the opening of the users' chest cavity providing good airflow to promote alertness.
- Users' feet remain flat.

Tilt Tension Control

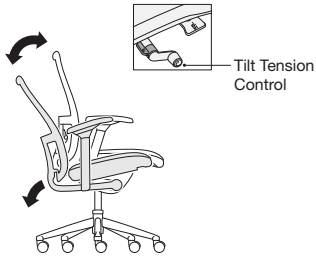

Feature:

- Easy-to-reach and easy-to-activate side-mounted tilt tension control regulates the amount of resistance felt when leaning back in the chair and the effort required to recline the chair backwards.

Benefit:

- Personalized support to accommodate users of different body types and different work styles.

Seat Height Adjustment

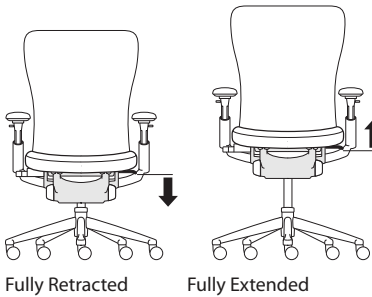

Features:

- Pneumatic seat height adjustment.
- Task chair seat height adjusts 5"(127mm) from 16" to 21"(406mm to 533mm) in standard models. Low-position adjusts 14" to 17"(356 to 432mm).
- Task stool seat height adjusts 7.5"(191mm) from 21.5" to 29"(546mm to 737mm).

Benefits:

- Ensures the comfort of the lower limbs by avoiding pressure on the underside of the thigh caused by a seat pan that is too high, or decreased thigh-to-torso angle if the seat pan is too low.
- Accommodates for users between approximately 4'11"(1499mm) and 6'3"(1905mm) tall to provide good leg circulation.
- Seat height adjustment also is important in setting the proper hand position and allowing for a proper sitting eye height.

Seat Depth Adjustment

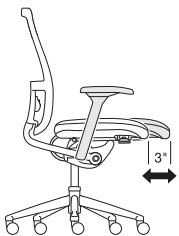

Features:

- 3"(76mm) of seat depth range. (Fixed seat also available.)
- Available with conventional foam material or optional Technogel® Soft Lite gel insert.
- Waterfall edge.

Benefit:

- Supports the thighs, allows users to rest against the seat back for back support, and avoids pressure on the back of the knees of small to tall users.

Upper Back Torsional Movement



Feature:

- Passive 2"(51mm) of torsional flex in the upper back.
- Patented mesh with built in tension zones for added comfort.

Benefit:

- Increases users' mobility and comfort when reaching sideways for objects.

Zody

General Specifications

OPTIONAL MOBILITY AND ADJUSTABILITY

PAL Back System**Features:**

- PAL Back System includes Asymmetrical Lumbar Adjustment and passive pelvic support.
- Asymmetrical Lumbar Adjustment adjusts 4"(102mm) in height; support level can be adjusted independently for right or left-hand side of users' body.
- Passive pelvic support.

Benefits:

- Lumbar adjustment maintains the natural curvature of the spine at the lower back and allows users to choose the support that feels right for them.
- Passive pelvic support rotates the pelvis forward to maintain the natural spine shape.

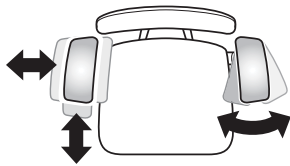
4D Arm**Features:**

- Optional 4D arm.
- Arm adjusts in 4 ways:
 - Height adjustment: 4"(102mm)
 - Side-to-side arm cap adjustment range: 3"(76mm) [1.5"(38mm) each arm cap]
 - Front-to-back adjustment range: 3.5"(89mm)
 - Pivoting: In 20°; out 20°

Benefits:

- Arms support the muscular system of users' neck and shoulders and proper arm support provides back relief. Arms can be an aid in standing or sitting down.
- Height adjustment accommodates for users with varying elbow rest heights so that users avoid lifting their shoulders or leaning sideways to get arm support.
- Front-to-back adjustment adjusts the armrest length, which is important because it allows users to get close to the worksurface while maintaining the effective use of the backrest.
- Side-to-side adjustment ensures a comfortable resting position for the arms with proper support of the forearm while allowing for easy entry/exit of the chair.
- Pivoting provides proper support of the forearm when performing tasks involving keying and mousing.

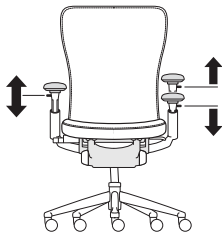
Adjustable Height Arm**Feature:**

- Optional height adjustable arms adjust 4"(102mm) vertically.

Benefit:

- Height adjustment accommodates users with varying elbow rest heights so that users avoid lifting their shoulders or leaning sideways to get arm support.

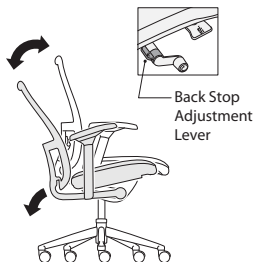
Tilt with Back Stop**Features:**

- Optional back stop;
- Back stops in 6 positions - upright and every 4° backward.
- Tilt limiter.

Benefit:

- Allows users the choice of selecting an upright position or limiting the amount of recline while performing different tasks.

Zody

General Specifications

OPTIONAL MOBILITY AND ADJUSTABILITY (continued)

Back Stop/Forward Tilt

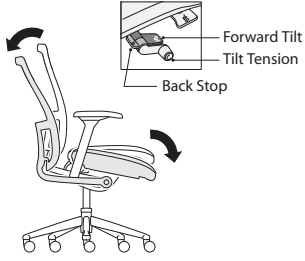

Feature:

- Optional back-stop and forward tilt.
- Back stops in 6 positions, upright and every 4° backward.
- Seat pan moves downward 5° from the initial position.

Benefit:

- Allows users to vary their posture for maximum comfort and for changes in task requirements.

Note: Not available on task stool.

Base

Standard Plastic Base

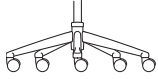

TR-F Black

Note: When plastic base is specified all metal trim defaults to Black (TF-F)

Optional Aluminum Base

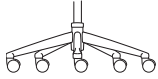

TR-F Black

TR-LE Metallic Silver

TR-MC Metallic Champagne

TR-MG Metallic Gunmetal*

PM-P Polished Aluminum

Low Position Base (Aluminum only)

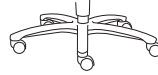

TR-F Black

TR-LE Metallic Silver

TR-MC Metallic Champagne

TR-MG Metallic Gunmetal*

*Color on Alert status and being considered for future obsolescence due to low volume.

Note: Low Position Base not available on stool.

Ergonomic Standards Guidelines

- All Zody models meet or exceed all ANSI/BIFMA durability standards for office seating.
- Zody meets the following ergonomic standards/guidelines:
 - BSR/HFES 100-2002
 - BIFMA G1-2002
 - CSA-Z412-2000
 - CAN/CGSB 44.232-2002
 - HFES 2007

Zody

General Specifications
UPHOLSTERY / AESTHETIC OPTIONS

Leather Upholstery



Seat: Stitched double seams. Vertically in the center and on the edges of the seat cushion.

Back: Vertical stitched double seams on the upholstered back jacket with leather or Customers Own Leather (COL).

Upholstered Back Jacket

Front View:

Leather Jacket



Back View:



Features

- Removable.
- Back jacket covers the inside back of the chairs allowing a back view of the mesh. Jacket consists of padding covered with fabric or leather upholstery.
- Available in fabric, faux leather, leather, COM and COL.

Headrest



Features

- Height-adjustable 2.5" to fit a wide range of users, headrest is TPU material, like Zody arm.
 - Trim color of headrest front and back are in same color. Black or Smoke only. If a trim color other than Black or Smoke is specified, the headrest will default to Black or Smoke based on the matrix below.
 - Headrest sent not attached; 10.5"W x 7.5"H, 2.5" height adjustment.
 - See Zody price pages for specification (available on all task seating models). Not available on stools. Specification Example: SZE-22-722MA1 (Zody with headrest, 4D arm).
- To add a headrest to an existing model in the field order service part: Back and Headrest replacement, see e-Parts.

Specification

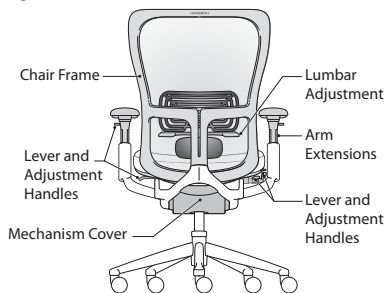

Features

- Trim color specification applies to the following components:
 - Chair frame
 - Levers
 - Adjustment handles
 - Lumbar adjustment (not lumbar pad)
 - Arm extensions
 - Mechanism covers
- Arm cap and Headrest color defaults based on the matrix below.

Trim Color	Arm Cap & Headrest Color*	
	Black	Smoke
Black (TR-F)	•	
Smoke (TR-E)		•
Snow (TR-UFM)		•

*Not specifiable.

This page intentionally blank

Zody

Task Chair with 4D Arms



SZT-20-702MA1

Dimensions*

- *SH: 16-21"
(406mm-533mm)
- H: 38-43"(965mm-1092mm)
- D: 29"(737mm)
- W: 29"(737mm)
- *SW: 19.25"(489mm)
- *SD: 16-19"(406mm-483mm)
- *AH: 6.8-10.8"
(173mm-274mm)

Low position seat height:
14-17"(356mm-432mm)

* All measurements taken with the BIFMA chair measuring device.

Trim Color ¹	Arm Cap & Headrest Color*	
	Black	Smoke
Black (TR-F)	•	
Smoke (TR-E)		•
Snow (TR-UFM)		•

*Not specifiable.

¹Plastic base option will default all metal trim to Black (TR-F).

Features

- Back: Knit, mesh, or mesh back with upholstered back jacket.
- Seat: Standard upholstered with foam or optional foam with Technogel® Soft Lite gel insert.
- Seat Type: Standard adjustable [3"(76mm) range] or optional fixed.
- Base: Standard Plastic painted five-star base or optional painted aluminum or polished aluminum. –Plastic base available in Black. –Aluminum base available with painted Black, Metallic Silver, Metallic Champagne, or optional Polished Aluminum.
- Arms: 4D with soft arm caps. See matrix for default colors.
- Mechanism: Balanced 3-point tilt; standard tilt tension.
- Height adjustment: Pneumatic or low-position pneumatic.
- Optional Back Stop: Tilt stop in 6 positions.
- Optional Back Stop with Forward Tilt; Seat tilts 5° downward from initial position.
- Optional Asymmetrical Lumbar Adjustment: 4"(102mm) height adjustment; support level can be adjusted independently for right or left hand side of users body. Optional PAL Back System: Passive pelvic support.
- Casters: Hard or soft casters in black only.
- COM yardage / COL square footage:
Mesh back model: .75/10
Mesh back/upholstered back jacket: 1.5/18

NOTE: When specifying fabric or leather back jacket; must also specify mesh surface color for outside back.

Upcharge for mixed grade surfaces, refer to the electronic design and specification tools.

To Order with Fabric or Leather Upholstered Back Jacket Specify:

1) Product number, including:

1 Base/Caster Option:

Aluminum Base

- 1 Aluminum Base, Hard Caster, add **\$35.64** to list
- 2 Aluminum Base, Soft Caster, add **\$80.64** to list
- 3 Aluminum Low Base, Hard Caster, add **\$35.64** to list
- 4 Aluminum Low Base, Soft Caster, add **\$80.64** to list

Plastic Base

- 5 Plastic Std. Base, Hard Caster
- 6 Plastic Std. Base, Soft Caster, add **\$45.00** to list

- 2) Fabric surface and color (seat).
- 3) Mesh surface color (back).
- 4) Fabric surface and color (back jacket).
- 5) Trim color for frame. (Add **\$61.00** list for Snow.)
- 6) Trim color for base/arms. (Add **\$208.32** list for polished aluminum.)

To Order with Knit or Mesh Back Specify:

1) Product number, including:

1 Base/Caster Option:

Aluminum Base

- 1 Aluminum Base, Hard Caster, add **\$35.64** to list
- 2 Aluminum Base, Soft Caster, add **\$80.64** to list
- 3 Aluminum Low Base, Hard Caster, add **\$35.64** to list
- 4 Aluminum Low Base, Soft Caster, add **\$80.64** to list

Plastic Base

- 5 Plastic Std. Base, Hard Caster
- 6 Plastic Std. Base, Soft Caster, add **\$45.00** to list

- 2) Fabric surface and color (seat).
- 3) Knit or Mesh surface and color (back).
- 4) Trim color for frame. (Add **\$61.00** list for Snow.)
- 5) Trim color for base/arms. (Add **\$208.32** list for polished aluminum.)

Zody

Task Chair with 4D Arms

 **OBSOLETE** | September 2022
Pneumatic configurations have been obsolete.

Upholstered		Fabric Grade										Leather	Leather
Foam Seat	Adjustments	Number	A	B	C	D	E	F	G	H	Grade A	Grade B	
No Lumbar Adjustment - Mesh Back w/Plastic Base													
Pneumatic		SZT-20-702MA	\$1349.54	\$1386.96	\$1426.87	\$1446.84	\$1461.81	\$1497.99	\$1530.41	\$1618.98	\$1680.10	\$1842.58	
Back Stop		SZT-20-701MA	1349.54	1386.96	1426.87	1446.84	1461.81	1497.99	1530.41	1618.98	1680.10	1842.58	
Back Stop/ Forward Tilt		SZT-20-704MA	1414.47	1451.89	1491.80	1511.77	1526.74	1562.92	1595.34	1683.91	1745.03	1907.51	
No Lumbar Adjustment - Knit Back w/Plastic Base													
Pneumatic		SZT-20-702MA	\$1498.17	\$1535.59	\$1575.50	\$1595.47	\$1610.44	\$1646.62	\$1679.04	\$1767.61	\$1828.73	\$1991.21	
Back Stop		SZT-20-701MA	1498.17	1535.59	1575.50	1595.47	1610.44	1646.62	1679.04	1767.61	1828.73	1991.21	
Back Stop/ Forward Tilt		SZT-20-704MA	1563.10	1600.52	1640.43	1660.40	1675.37	1711.55	1743.97	1832.54	1893.66	2056.14	
No Lumbar Adjustment - Upholstered Back Jacket w/Plastic Base													
Pneumatic		SZT-22-702MA	\$1473.03	\$1547.87	\$1627.69	\$1667.63	\$1697.57	\$1769.93	\$1834.77	\$2011.91	\$2134.15	\$2459.11	
Back Stop		SZT-22-701MA	1473.03	1547.87	1627.69	1667.63	1697.57	1769.93	1834.77	2011.91	2134.15	2459.11	
Back Stop/ Forward Tilt		SZT-22-704MA	1537.96	1612.80	1692.62	1732.56	1762.50	1834.86	1899.70	2076.84	2199.08	2524.04	
Lumbar Adjustment - Mesh Back w/Plastic Base													
Pneumatic		SZT-20-712MA	\$1459.32	\$1496.74	\$1536.65	\$1556.62	\$1571.59	\$1607.77	\$1640.19	\$1728.76	\$1789.88	\$1952.36	
Back Stop		SZT-20-711MA	1459.32	1496.74	1536.65	1556.62	1571.59	1607.77	1640.19	1728.76	1789.88	1952.36	
Back Stop/ Forward Tilt		SZT-20-714MA	1524.25	1561.67	1601.58	1621.55	1636.52	1672.70	1705.12	1793.69	1854.81	2017.29	
Lumbar Adjustment - Knit Back w/Plastic Base													
Pneumatic		SZT-20-712MA	\$1607.95	\$1645.37	\$1685.28	\$1705.25	\$1720.22	\$1756.40	\$1788.82	\$1877.39	\$1938.51	\$2100.99	
Back Stop		SZT-20-711MA	1607.95	1645.37	1685.28	1705.25	1720.22	1756.40	1788.82	1877.39	1938.51	2100.99	
Back Stop/ Forward Tilt		SZT-20-714MA	1672.88	1710.30	1750.21	1770.18	1785.15	1821.33	1853.75	1942.32	2003.44	2165.92	
Lumbar Adjustment - Upholstered Back Jacket w/Plastic Base													
Pneumatic		SZT-22-712MA	\$1582.81	\$1657.65	\$1737.47	\$1777.41	\$1807.35	\$1879.71	\$1944.55	\$2121.69	\$2243.93	\$2568.89	
Back Stop		SZT-22-711MA	1582.81	1657.65	1737.47	1777.41	1807.35	1879.71	1944.55	2121.69	2243.93	2568.89	
Back Stop/ Forward Tilt		SZT-22-714MA	1647.74	1722.58	1802.40	1842.34	1872.28	1944.64	2009.48	2186.62	2308.86	2633.82	
PAL Back System - Mesh Back w/Plastic Base													
Pneumatic		SZT-20-722MA	\$1488.01	\$1525.43	\$1565.34	\$1585.31	\$1600.28	\$1636.46	\$1668.88	\$1757.45	\$1818.57	\$1981.05	
Back Stop		SZT-20-721MA	1488.01	1525.43	1565.34	1585.31	1600.28	1636.46	1668.88	1757.45	1818.57	1981.05	
Back Stop/ Forward Tilt		SZT-20-724MA	1552.94	1590.36	1630.27	1650.24	1665.21	1701.39	1733.81	1822.38	1883.50	2045.98	
PAL Back System - Knit Back w/Plastic Base													
Pneumatic		SZT-20-722MA	\$1636.64	\$1674.06	\$1713.97	\$1733.94	\$1748.91	\$1785.09	\$1817.51	\$1906.08	\$1967.20	\$2129.68	
Back Stop		SZT-20-721MA	1636.64	1674.06	1713.97	1733.94	1748.91	1785.09	1817.51	1906.08	1967.20	2129.68	
Back Stop/ Forward Tilt		SZT-20-724MA	1701.57	1738.99	1778.90	1798.87	1813.84	1850.02	1882.44	1971.01	2032.13	2194.61	
PAL Back System - Upholstered Back Jacket w/Plastic Base													
Pneumatic		SZT-22-722MA	\$1611.50	\$1686.34	\$1766.16	\$1806.10	\$1836.04	\$1908.40	\$1973.24	\$2150.38	\$2272.62	\$2597.58	
Back Stop		SZT-22-721MA	1611.50	1686.34	1766.16	1806.10	1836.04	1908.40	1973.24	2150.38	2272.62	2597.58	
Back Stop/ Forward Tilt		SZT-22-724MA	1676.43	1751.27	1831.09	1871.03	1900.97	1973.33	2038.17	2215.31	2337.55	2662.51	

The following options require modification of the product number.

- Fixed seat
- Headrest
- Stain repellent
- Leather Seat with Mesh Back
- Leather Seat with Leather Upholstered Back Jacket
- Faux Leather Seat with Mesh Back
- Faux Leather Seat with Faux Leather Upholstered Back Jacket

- To specify, change the 10th digit from A to X; **Example:** SZT-20-702MX1
- To specify, change the 3rd digit from a T to an E; **Example:** SZE-22-702MA1 with headrest (add \$64.86 list)
- To specify, add P to end of the product number (add \$38.67 list)
- To specify, change the 4th digit to 1 and 5th digit to 0; **Example:** SZT-10-702MA5
- To specify, change the 4th digit to 1 and 5th digit to 1; **Example:** SZT-11-702MA5
- To specify, change the 4th digit to 3; **Example:** SZT-30-702MA5
- To specify, change the 4th and 5th digits to 33; **Example:** SZT-33-702MA5

NOTE: For available fabrics, refer to surfaces.haworth.com.

⚠️ OBSOLETE | September 2022
Pneumatic configurations have been obsolete.

Zody
Task Chair with 4D Arms

Upholstered		Fabric Grade										Leather	Leather
Gel Insert Seat	Adjustments	Number	A	B	C	D	E	F	G	H	Grade A	Grade B	
No Lumbar Adjustment - Mesh Back w/Plastic Base													
Pneumatic	SZT-20-702EA	■	\$1453.09	\$1490.51	\$1530.42	\$1550.39	\$1565.36	\$1601.54	\$1633.96	\$1722.53	\$1783.65	\$1946.13	
Back Stop	SZT-20-701EA	■	1453.09	1490.51	1530.42	1550.39	1565.36	1601.54	1633.96	1722.53	1783.65	1946.13	
Back Stop/ Forward Tilt	SZT-20-704EA	■	1518.02	1555.44	1595.35	1615.32	1630.29	1666.47	1698.89	1787.46	1848.58	2011.06	
No Lumbar Adjustment - Knit Back w/Plastic Base													
Pneumatic	SZT-20-702EA	■	\$1601.72	\$1639.14	\$1679.05	\$1699.02	\$1713.99	\$1750.17	\$1782.59	\$1871.16	\$1932.28	\$2094.76	
Back Stop	SZT-20-701EA	■	1601.72	1639.14	1679.05	1699.02	1713.99	1750.17	1782.59	1871.16	1932.28	2094.76	
Back Stop/ Forward Tilt	SZT-20-704EA	■	1666.65	1704.07	1743.98	1763.95	1778.92	1815.10	1847.52	1936.09	1997.21	2159.69	
No Lumbar Adjustment - Upholstered Back Jacket w/Plastic Base													
Pneumatic	SZT-22-702EA	■	\$1576.58	\$1651.42	\$1731.24	\$1771.18	\$1801.12	\$1873.48	\$1938.32	\$2115.46	\$2237.70	\$2562.66	
Back Stop	SZT-22-701EA	■	1576.58	1651.42	1731.24	1771.18	1801.12	1873.48	1938.32	2115.46	2237.70	2562.66	
Back Stop/ Forward Tilt	SZT-22-704EA	■	1641.51	1716.35	1796.17	1836.11	1866.05	1938.41	2003.25	2180.39	2302.63	2627.59	
Lumbar Adjustment - Mesh Back w/Plastic Base													
Pneumatic	SZT-20-712EA	■	\$1562.87	\$1600.29	\$1640.20	\$1660.17	\$1675.14	\$1711.32	\$1743.74	\$1832.31	\$1893.43	\$2055.91	
Back Stop	SZT-20-711EA	■	1562.87	1600.29	1640.20	1660.17	1675.14	1711.32	1743.74	1832.31	1893.43	2055.91	
Back Stop/ Forward Tilt	SZT-20-714EA	■	1627.80	1665.22	1705.13	1725.10	1740.07	1776.25	1808.67	1897.24	1958.36	2120.84	
Lumbar Adjustment - Knit Back w/Plastic Base													
Pneumatic	SZT-20-712EA	■	\$1711.50	\$1748.92	\$1788.83	\$1808.80	\$1823.77	\$1859.95	\$1892.37	\$1980.94	\$2042.06	\$2204.54	
Back Stop	SZT-20-711EA	■	1711.50	1748.92	1788.83	1808.80	1823.77	1859.95	1892.37	1980.94	2042.06	2204.54	
Back Stop/ Forward Tilt	SZT-20-714EA	■	1776.43	1813.85	1853.76	1873.73	1888.70	1924.88	1957.30	2045.87	2106.99	2269.47	
Lumbar Adjustment - Upholstered Back Jacket w/Plastic Base													
Pneumatic	SZT-22-712EA	■	\$1686.36	\$1761.20	\$1841.02	\$1880.96	\$1910.90	\$1983.26	\$2048.10	\$2225.24	\$2347.48	\$2672.44	
Back Stop	SZT-22-711EA	■	1686.36	1761.20	1841.02	1880.96	1910.90	1983.26	2048.10	2225.24	2347.48	2672.44	
Back Stop/ Forward Tilt	SZT-22-714EA	■	1751.29	1826.13	1905.95	1945.89	1975.83	2048.19	2113.03	2290.17	2412.41	2737.37	
PAL Back System - Mesh Back w/Plastic Base													
Pneumatic	SZT-20-722EA	■	\$1591.56	\$1628.98	\$1668.89	\$1688.86	\$1703.83	\$1740.01	\$1772.43	\$1861.00	\$1922.12	\$2084.60	
Back Stop	SZT-20-721EA	■	1591.56	1628.98	1668.89	1688.86	1703.83	1740.01	1772.43	1861.00	1922.12	2084.60	
Back Stop/ Forward Tilt	SZT-20-724EA	■	1656.49	1693.91	1733.82	1753.79	1768.76	1804.94	1837.36	1925.93	1987.05	2149.53	
PAL Back System - Knit Back w/Plastic Base													
Pneumatic	SZT-20-722EA	■	\$1740.19	\$1777.61	\$1817.52	\$1837.49	\$1852.46	\$1888.64	\$1921.06	\$2009.63	\$2070.75	\$2233.23	
Back Stop	SZT-20-721EA	■	1740.19	1777.61	1817.52	1837.49	1852.46	1888.64	1921.06	2009.63	2070.75	2233.23	
Back Stop/ Forward Tilt	SZT-20-724EA	■	1805.12	1842.54	1882.45	1902.42	1917.39	1953.57	1985.99	2074.56	2135.68	2298.16	
PAL Back System - Upholstered Back Jacket w/Plastic Base													
Pneumatic	SZT-22-722EA	■	\$1715.05	\$1789.89	\$1869.71	\$1909.65	\$1939.59	\$2011.95	\$2076.79	\$2253.93	\$2376.17	\$2701.13	
Back Stop	SZT-22-721EA	■	1715.05	1789.89	1869.71	1909.65	1939.59	2011.95	2076.79	2253.93	2376.17	2701.13	
Back Stop/ Forward Tilt	SZT-22-724EA	■	1779.98	1854.82	1934.64	1974.58	2004.52	2076.88	2141.72	2318.86	2441.10	2766.06	

The following options require modification of the product number.

- Fixed seat
- Headrest
- Stain repellent
- Leather Seat with Mesh Back
- Leather Seat with Leather Upholstered Back Jacket
- Faux Leather Seat with Mesh Back
- Faux Leather Seat with Faux Leather Upholstered Back Jacket

- To specify, change the 10th digit from A to X; **Example:** SZT-20-702EX1
- To specify, change the 3rd digit from a T to an E; **Example:** SZE-22-702EA1 with headrest (add \$64.86 list)
- To specify, add P to end of the product number (add \$38.67 list)
- To specify, change the 4th digit to 1 and 5th digit to 0; **Example:** SZT-10-702EA5
- To specify, change the 4th digit to 1 and 5th digit to 1; **Example:** SZT-11-702EA5
- To specify, change the 4th digit to 3; **Example:** SZT-30-702EA5
- To specify, change the 4th and 5th digits to 33; **Example:** SZT-33-702EA5
- NOTE:** For available fabrics, refer to surfaces.haworth.com.

This page intentionally blank

Zody

Task Chair with Height Adjustable Arms



SZT-20-402MA1

Dimensions*

- *SH: 16-21"
(406mm-533mm)
- H: 38-43"(965mm-1092mm)
- D: 29"(737mm)
- W: 29"(737mm)
- *SW: 19.25"(489mm)
- *SD: 16-19"(406mm-483mm)
- *AH: 6.8-10.8"
(173mm-274mm)

Low position seat height:
14-17"(356mm-432mm)

* All measurements taken with the BIFMA chair measuring device.

Trim Color ¹	Arm Cap & Headrest Color*	
	Black	Smoke
Black (TR-F)	•	
Smoke (TR-E)		•
Snow (TR-UFM)		•

*Not specifiable.

¹Plastic base option will default all metal trim to Black (TR-F).

Features

- Back: Knit, mesh, or mesh back with upholstered back jacket.
- Seat: Standard upholstered with foam or optional foam with Technogel[®] Soft Lite gel insert.
- Seat Type: Standard adjustable [3"(76mm) range] or optional fixed.
- Base: Standard Plastic painted five-star base or optional painted aluminum or polished aluminum.
 - Plastic base available in Black.
 - Aluminum base available with painted Black, Metallic Silver, Metallic Champagne, or optional Polished Aluminum.
- Arms: Height-adjustable with soft arm caps. See matrix for default colors.
- Mechanism: Balanced 3-point tilt; standard tilt tension.
- Height adjustment: Pneumatic or low-position pneumatic.
- Optional Back Stop: Tilt stop in 6 positions.
- Optional Back Stop with Forward Tilt; Seat tilts 5° downward from initial position.
- Optional Asymmetrical Lumbar Adjustment: 4"(102mm) height adjustment; support level can be adjusted independently for right or left hand side of users body. Optional PAL Back System: Passive pelvic support.
- Casters: Hard or soft casters in black only.
- COM yardage / COL square footage:
 - Mesh back model: 0.75/10
 - Mesh back/upholstered back jacket: 1.5/18

NOTE: When specifying fabric or leather back jacket; must also specify mesh surface color for outside back.

Upcharge for mixed grade surfaces, refer to the electronic design and specification tools.

To Order with Fabric or Leather Upholstered Back Jacket Specify:

1) Product number, including:

1 Base/Caster Option:

Aluminum Base

- 1 Aluminum Base, Hard Caster, add **\$35.64** to list
- 2 Aluminum Base, Soft Caster, add **\$80.64** to list
- 3 Aluminum Low Base, Hard Caster, add **\$35.64** to list
- 4 Aluminum Low Base, Soft Caster, add **\$80.64** to list

Plastic Base

- 5 Plastic Std. Base, Hard Caster
- 6 Plastic Std. Base, Soft Caster, add **\$45.00** to list

- 2) Fabric surface and color (seat).
- 3) Mesh surface color (back).
- 4) Fabric surface and color (back jacket).
- 5) Trim color for frame. (Add **\$61.00** list for Snow.)
- 6) Trim color for base/arms. (Add **\$208.32** list for polished aluminum.)

To Order with Knit or Mesh Back Specify:

1) Product number, including:

1 Base/Caster Option:

Aluminum Base

- 1 Aluminum Base, Hard Caster, add **\$35.64** to list
- 2 Aluminum Base, Soft Caster, add **\$80.64** to list
- 3 Aluminum Low Base, Hard Caster, add **\$35.64** to list
- 4 Aluminum Low Base, Soft Caster, add **\$80.64** to list

Plastic Base

- 5 Plastic Std. Base, Hard Caster
- 6 Plastic Std. Base, Soft Caster, add **\$45.00** to list

- 2) Fabric surface and color (seat).
- 3) Knit or Mesh surface and color (back).
- 4) Trim color for frame. (Add **\$61.00** list for Snow.)
- 5) Trim color for base/arms. (Add **\$208.32** list for polished aluminum.)

Zody

Task Chair with Height Adjustable Arms

⚠️ OBSOLETE | September 2022
Pneumatic configurations have been obsolete.

Upholstered Foam Seat	Adjustments	Number	①	Fabric Grade								Leather Grade A	Leather Grade B
				A	B	C	D	E	F	G	H		
No Lumbar Adjustment - Mesh w/Plastic Base													
Pneumatic		SZT-20-402MA		\$1308.37	\$1345.79	\$1385.70	\$1405.67	\$1420.64	\$1456.82	\$1489.24	\$1577.81	\$1638.93	\$1801.41
Back Stop		SZT-20-401MA		1308.37	1345.79	1385.70	1405.67	1420.64	1456.82	1489.24	1577.81	1638.93	1801.41
Back Stop/ Forward Tilt		SZT-20-404MA		1373.30	1410.72	1450.63	1470.60	1485.57	1521.75	1554.17	1642.74	1703.86	1866.34
No Lumbar Adjustment - Knit w/Plastic Base													
Pneumatic		SZT-20-402MA		\$1457.00	\$1494.42	\$1534.33	\$1554.30	\$1569.27	\$1605.45	\$1637.87	\$1726.44	\$1787.56	\$1950.04
Back Stop		SZT-20-401MA		1457.00	1494.42	1534.33	1554.30	1569.27	1605.45	1637.87	1726.44	1787.56	1950.04
Back Stop/ Forward Tilt		SZT-20-404MA		1521.93	1559.35	1599.26	1619.23	1634.20	1670.38	1702.80	1791.37	1852.49	2014.97
No Lumbar Adjustment - Upholstered Back Jacket w/Plastic Base													
Pneumatic		SZT-22-402MA		\$1431.86	\$1506.70	\$1586.52	\$1626.46	\$1656.40	\$1728.76	\$1793.60	\$1970.74	\$2092.98	\$2417.94
Back Stop		SZT-22-401MA		1431.86	1506.70	1586.52	1626.46	1656.40	1728.76	1793.60	1970.74	2092.98	2417.94
Back Stop/ Forward Tilt		SZT-22-404MA		1496.79	1571.63	1651.45	1691.39	1721.33	1793.69	1858.53	2035.67	2157.91	2482.87
Lumbar Adjustment - Mesh w/Plastic Base													
Pneumatic		SZT-20-412MA		\$1418.15	\$1455.57	\$1495.48	\$1515.45	\$1530.42	\$1566.60	\$1599.02	\$1687.59	\$1748.71	\$1911.19
Back Stop		SZT-20-411MA		1418.15	1455.57	1495.48	1515.45	1530.42	1566.60	1599.02	1687.59	1748.71	1911.19
Back Stop/ Forward Tilt		SZT-20-414MA		1483.08	1520.50	1560.41	1580.38	1595.35	1631.53	1663.95	1752.52	1813.64	1976.12
Lumbar Adjustment - Knit w/Plastic Base													
Pneumatic		SZT-20-412MA		\$1566.78	\$1604.20	\$1644.11	\$1664.08	\$1679.05	\$1715.23	\$1747.65	\$1836.22	\$1897.34	\$2059.82
Back Stop		SZT-20-411MA		1566.78	1604.20	1644.11	1664.08	1679.05	1715.23	1747.65	1836.22	1897.34	2059.82
Back Stop/ Forward Tilt		SZT-20-414MA		1631.71	1669.13	1709.04	1729.01	1743.98	1780.16	1812.58	1901.15	1962.27	2124.75
Lumbar Adjustment - Upholstered Back Jacket w/Plastic Base													
Pneumatic		SZT-22-412MA		\$1541.64	\$1616.48	\$1696.30	\$1736.24	\$1766.18	\$1838.54	\$1903.38	\$2080.52	\$2202.76	\$2527.72
Back Stop		SZT-22-411MA		1541.64	1616.48	1696.30	1736.24	1766.18	1838.54	1903.38	2080.52	2202.76	2527.72
Back Stop/ Forward Tilt		SZT-22-414MA		1606.57	1681.41	1761.23	1801.17	1831.11	1903.47	1968.31	2145.45	2267.69	2592.65
PAL Back System - Mesh w/Plastic Base													
Pneumatic		SZT-20-422MA		\$1446.84	\$1484.26	\$1524.17	\$1544.14	\$1559.11	\$1595.29	\$1627.71	\$1716.28	\$1777.40	\$1939.88
Back Stop		SZT-20-421MA		1446.84	1484.26	1524.17	1544.14	1559.11	1595.29	1627.71	1716.28	1777.40	1939.88
Back Stop/ Forward Tilt		SZT-20-424MA		1511.77	1549.19	1589.10	1609.07	1624.04	1660.22	1692.64	1781.21	1842.33	2004.81
PAL Back System - Knit w/Plastic Base													
Pneumatic		SZT-20-422MA		\$1595.47	\$1632.89	\$1672.80	\$1692.77	\$1707.74	\$1743.92	\$1776.34	\$1864.91	\$1926.03	\$2088.51
Back Stop		SZT-20-421MA		1595.47	1632.89	1672.80	1692.77	1707.74	1743.92	1776.34	1864.91	1926.03	2088.51
Back Stop/ Forward Tilt		SZT-20-424MA		1660.40	1697.82	1737.73	1757.70	1772.67	1808.85	1841.27	1929.84	1990.96	2153.44
PAL Back System - Upholstered Back Jacket w/Plastic Base													
Pneumatic		SZT-22-422MA		\$1570.33	\$1645.17	\$1724.99	\$1764.93	\$1794.87	\$1867.23	\$1932.07	\$2109.21	\$2231.45	\$2556.41
Back Stop		SZT-22-421MA		1570.33	1645.17	1724.99	1764.93	1794.87	1867.23	1932.07	2109.21	2231.45	2556.41
Back Stop/ Forward Tilt		SZT-22-424MA		1635.26	1710.10	1789.92	1829.86	1859.80	1932.16	1997.00	2174.14	2296.38	2621.34

The following options require modification of the product number.

- Fixed seat
- Headrest
- Stain repellent
- Leather Seat with Mesh Back
- Leather Seat with Leather Upholstered Back Jacket
- Faux Leather Seat with Mesh Back
- Faux Leather Seat with Faux Leather Upholstered Back Jacket

- To specify, change the 10th digit from A to X; **Example:** SZT-20-402MX1
- To specify, change the 3rd digit from a T to an E; **Example:** SZE-22-402MA1 with headrest (add \$64.86 list)
- To specify, add P to end of the product number (add \$38.67 list)
- To specify, change the 4th digit to 1 and 5th digit to 0; **Example:** SZT-10-402MA5
- To specify, change the 4th digit to 1 and 5th digit to 1; **Example:** SZT-11-402MA5
- To specify, change the 4th digit to 3; **Example:** SZT-30-402MA5
- To specify, change the 4th and 5th digits to 33; **Example:** SZT-33-402MA5

NOTE: For available fabrics, refer to surfaces.haworth.com.

! OBSOLETE | September 2022 Task Chair with Height Adjustable Arms
Pneumatic configurations have been obsolete.

Zody

Upholstered		Fabric Grade										Leather	Leather
Gel Insert Seat	Adjustments	Number	A	B	C	D	E	F	G	H	Grade A	Grade B	
No Lumbar Adjustment - Mesh w/Plastic Base													
Pneumatic	SZT-20-402EA	■	\$1411.92	\$1449.34	\$1489.25	\$1509.22	\$1524.19	\$1560.37	\$1592.79	\$1681.36	\$1742.48	\$1904.96	
Back Stop	SZT-20-401EA	■	1411.92	1449.34	1489.25	1509.22	1524.19	1560.37	1592.79	1681.36	1742.48	1904.96	
Back Stop/ Forward Tilt	SZT-20-404EA	■	1476.85	1514.27	1554.18	1574.15	1589.12	1625.30	1657.72	1746.29	1807.41	1969.89	
No Lumbar Adjustment - Knit w/Plastic Base													
Pneumatic	SZT-20-402EA	■	\$1560.55	\$1597.97	\$1637.88	\$1657.85	\$1672.82	\$1709.00	\$1741.42	\$1829.99	\$1891.11	\$2053.59	
Back Stop	SZT-20-401EA	■	1560.55	1597.97	1637.88	1657.85	1672.82	1709.00	1741.42	1829.99	1891.11	2053.59	
Back Stop/ Forward Tilt	SZT-20-404EA	■	1625.48	1662.90	1702.81	1722.78	1737.75	1773.93	1806.35	1894.92	1956.04	2118.52	
No Lumbar Adjustment - Upholstered Back Jacket w/Plastic Base													
Pneumatic	SZT-22-402EA	■	\$1535.41	\$1610.25	\$1690.07	\$1730.01	\$1759.95	\$1832.31	\$1897.15	\$2074.29	\$2196.53	\$2521.49	
Back Stop	SZT-22-401EA	■	1535.41	1610.25	1690.07	1730.01	1759.95	1832.31	1897.15	2074.29	2196.53	2521.49	
Back Stop/ Forward Tilt	SZT-22-404EA	■	1600.34	1675.18	1755.00	1794.94	1824.88	1897.24	1962.08	2139.22	2261.46	2586.42	
Lumbar Adjustment - Mesh w/Plastic Base													
Pneumatic	SZT-20-412EA	■	\$1521.70	\$1559.12	\$1599.03	\$1619.00	\$1633.97	\$1670.15	\$1702.57	\$1791.14	\$1852.26	\$2014.74	
Back Stop	SZT-20-411EA	■	1521.70	1559.12	1599.03	1619.00	1633.97	1670.15	1702.57	1791.14	1852.26	2014.74	
Back Stop/ Forward Tilt	SZT-20-414EA	■	1586.63	1624.05	1663.96	1683.93	1698.90	1735.08	1767.50	1856.07	1917.19	2079.67	
Lumbar Adjustment - Knit w/Plastic Base													
Pneumatic	SZT-20-412EA	■	\$1670.33	\$1707.75	\$1747.66	\$1767.63	\$1782.60	\$1818.78	\$1851.20	\$1939.77	\$2000.89	\$2163.37	
Back Stop	SZT-20-411EA	■	1670.33	1707.75	1747.66	1767.63	1782.60	1818.78	1851.20	1939.77	2000.89	2163.37	
Back Stop/ Forward Tilt	SZT-20-414EA	■	1735.26	1772.68	1812.59	1832.56	1847.53	1883.71	1916.13	2004.70	2065.82	2228.30	
Lumbar Adjustment - Upholstered Back Jacket w/Plastic Base													
Pneumatic	SZT-22-412EA	■	\$1645.19	\$1720.03	\$1799.85	\$1839.79	\$1869.73	\$1942.09	\$2006.93	\$2184.07	\$2306.31	\$2631.27	
Back Stop	SZT-22-411EA	■	1645.19	1720.03	1799.85	1839.79	1869.73	1942.09	2006.93	2184.07	2306.31	2631.27	
Back Stop/ Forward Tilt	SZT-22-414EA	■	1710.12	1784.96	1864.78	1904.72	1934.66	2007.02	2071.86	2249.00	2371.24	2696.20	
PAL Back System - Mesh w/Plastic Base													
Pneumatic	SZT-20-422EA	■	\$1550.39	\$1587.81	\$1627.72	\$1647.69	\$1662.66	\$1698.84	\$1731.26	\$1819.83	\$1880.95	\$2043.43	
Back Stop	SZT-20-421EA	■	1550.39	1587.81	1627.72	1647.69	1662.66	1698.84	1731.26	1819.83	1880.95	2043.43	
Back Stop/ Forward Tilt	SZT-20-424EA	■	1615.32	1652.74	1692.65	1712.62	1727.59	1763.77	1796.19	1884.76	1945.88	2108.36	
PAL Back System - Knit w/Plastic Base													
Pneumatic	SZT-20-422EA	■	\$1699.02	\$1736.44	\$1776.35	\$1796.32	\$1811.29	\$1847.47	\$1879.89	\$1968.46	\$2029.58	\$2192.06	
Back Stop	SZT-20-421EA	■	1699.02	1736.44	1776.35	1796.32	1811.29	1847.47	1879.89	1968.46	2029.58	2192.06	
Back Stop/ Forward Tilt	SZT-20-424EA	■	1763.95	1801.37	1841.28	1861.25	1876.22	1912.40	1944.82	2033.39	2094.51	2256.99	
PAL Back System - Upholstered Back Jacket w/Plastic Base													
Pneumatic	SZT-22-422EA	■	\$1673.88	\$1748.72	\$1828.54	\$1868.48	\$1898.42	\$1970.78	\$2035.62	\$2212.76	\$2335.00	\$2659.96	
Back Stop	SZT-22-421EA	■	1673.88	1748.72	1828.54	1868.48	1898.42	1970.78	2035.62	2212.76	2335.00	2659.96	
Back Stop/ Forward Tilt	SZT-22-424EA	■	1738.81	1813.65	1893.47	1933.41	1963.35	2035.71	2100.55	2277.69	2399.93	2724.89	

The following options require modification of the product number.

- Fixed seat
- Headrest
- Stain repellent
- Leather Seat with Mesh Back
- Leather Seat with Leather Upholstered Back Jacket
- Faux Leather Seat with Mesh Back
- Faux Leather Seat with Faux Leather Upholstered Back Jacket

- To specify, change the 10th digit from A to X; **Example:** SZT-20-402EX1
- To specify, change the 3rd digit from a T to an E; **Example:** SZE-22-402EA1 with headrest (add \$64.86 list)
- To specify, add P to end of the product number (add \$38.67 list)
- To specify, change the 4th digit to 1 and 5th digit to 0; **Example:** SZT-10-402EA5
- To specify, change the 4th digit to 1 and 5th digit to 1; **Example:** SZT-11-402EA5
- To specify, change the 4th digit to 3; **Example:** SZT-30-402EA5
- To specify, change the 4th and 5th digits to 33; **Example:** SZT-33-402EA5

NOTE: For available fabrics, refer to surfaces.haworth.com.

This page intentionally blank

Zody

Task Chair with Fixed Arms



SZT-20-102MA1

Dimensions*

- *SH: 16-21"
(406mm-533mm)
- H: 38-43"(965mm-1092mm)
- D: 29"(737mm)
- W: 29"(737mm)
- *SW: 19.25"(489mm)
- *SD: 16-19"(406mm-483mm)
- *AH: 9"(229mm)
- Low position seat height:
14-17"(356mm-432mm)

* All measurements taken with the BIFMA chair measuring device.

Trim Color ¹	Arm Cap & Headrest Color*	
	Black	Smoke
Black (TR-F)	•	
Smoke (TR-E)		•
Snow (TR-UFM)		•

*Not specifiable.

¹Plastic base option will default all metal trim to Black (TR-F).

Features

- Back: Knit, mesh, or mesh back with upholstered back jacket.
- Seat: Standard upholstered with foam or optional foam with Technogel[®] Soft Lite gel insert.
- Seat Type: Standard adjustable [3"(76mm) range] or optional fixed.
- Base: Standard Plastic painted five-star base or optional painted aluminum or polished aluminum. –Plastic base available in Black. –Aluminum base available with painted Black, Metallic Silver, Metallic Champagne, or optional Polished Aluminum.
- Arms: Fixed with soft arm caps. See matrix for default colors.
- Mechanism: Balanced 3-point tilt; standard tilt tension.
- Height adjustment: Pneumatic or low-position pneumatic.
- Optional Back Stop: Tilt stop in 6 positions.
- Optional Back Stop with Forward Tilt; Seat tilts 5° from initial position.
- Optional Asymmetrical Lumbar Adjustment: 4"(102mm) height adjustment; support level can be adjusted independently for right or left hand side of users body. Optional PAL Back System: Passive pelvic support.
- Casters: Hard or soft casters in black only.
- COM yardage / COL square footage:
Mesh back model: 0.75/10
Mesh back/upholstered back jacket: 1.5/18

NOTE: When specifying fabric or leather back jacket; must also specify mesh surface color for outside back.

Upcharge for mixed grade surfaces, refer to the electronic design and specification tools.

To Order with Fabric or Leather Upholstered Back Jacket Specify:

1) Product number, including:

1 Base/Caster Option:

Aluminum Base

- 1 Aluminum Base, Hard Caster, add **\$35.64** to list
- 2 Aluminum Base, Soft Caster, add **\$80.64** to list
- 3 Aluminum Low Base, Hard Caster, add **\$35.64** to list
- 4 Aluminum Low Base, Soft Caster, add **\$80.64** to list

Plastic Base

- 5 Plastic Std. Base, Hard Caster
- 6 Plastic Std. Base, Soft Caster, add **\$45.00** to list

- 2) Fabric surface and color (seat).
- 3) Mesh surface color (back).
- 4) Fabric surface and color (back jacket).
- 5) Trim color for frame. (Add **\$61.00** list for Snow.)
- 6) Trim color for base/arms. (Add **\$208.32** list for polished aluminum.)

To Order with Knit or Mesh Back Specify:

1) Product number, including:

1 Base/Caster Option:

Aluminum Base

- 1 Aluminum Base, Hard Caster, add **\$35.64** to list
- 2 Aluminum Base, Soft Caster, add **\$80.64** to list
- 3 Aluminum Low Base, Hard Caster, add **\$35.64** to list
- 4 Aluminum Low Base, Soft Caster, add **\$80.64** to list

Plastic Base

- 5 Plastic Std. Base, Hard Caster
- 6 Plastic Std. Base, Soft Caster, add **\$45.00** to list

- 2) Fabric surface and color (seat).
- 3) Knit or Mesh surface and color (back).
- 4) Trim color for frame. (Add **\$61.00** list for Snow.)
- 5) Trim color for base/arms. (Add **\$208.32** list for polished aluminum.)

Zody

Task Chair with Fixed Arms

 **OBSOLETE** | September 2022
Pneumatic configurations have been obsolete.

Upholstered Foam Seat	Adjustments	Number	Fabric Grade								Leather Grade A	Leather Grade B
			A	B	C	D	E	F	G	H		
No Lumbar Adjustment - Mesh Back w/Plastic Base												
Pneumatic		SZT 20-102MA	\$1223.55	\$1260.97	\$1300.88	\$1320.85	\$1335.82	\$1372.00	\$1404.42	\$1492.99	\$1554.11	\$1716.59
Back Stop		SZT-20-101MA	1223.55	1260.97	1300.88	1320.85	1335.82	1372.00	1404.42	1492.99	1554.11	1716.59
Back Stop/ Forward Tilt		SZT-20-104MA	1288.48	1325.90	1365.81	1385.78	1400.75	1436.93	1469.35	1557.92	1619.04	1781.52
No Lumbar Adjustment - Knit w/Plastic Base												
Pneumatic		SZT 20-102MA	\$1372.18	\$1409.60	\$1449.51	\$1469.48	\$1484.45	\$1520.63	\$1553.05	\$1641.62	\$1702.74	\$1865.22
Back Stop		SZT-20-101MA	1372.18	1409.60	1449.51	1469.48	1484.45	1520.63	1553.05	1641.62	1702.74	1865.22
Back Stop/ Forward Tilt		SZT-20-104MA	1437.11	1474.53	1514.44	1534.41	1549.38	1585.56	1617.98	1706.55	1767.67	1930.15
No Lumbar Adjustment - Upholstered Back Jacket w/Plastic Base												
Pneumatic		SZT 22-102MA	\$1347.04	\$1421.88	\$1501.70	\$1541.64	\$1571.58	\$1643.94	\$1708.78	\$1885.92	\$2008.16	\$2333.12
Back Stop		SZT-22-101MA	1347.04	1421.88	1501.70	1541.64	1571.58	1643.94	1708.78	1885.92	2008.16	2333.12
Back Stop/ Forward Tilt		SZT-22-104MA	1411.97	1486.81	1566.63	1606.57	1636.51	1708.87	1773.71	1950.85	2073.09	2398.05
Lumbar Adjustment - Mesh Back w/Plastic Base												
Pneumatic		SZT 20-112MA	\$1333.33	\$1370.75	\$1410.66	\$1430.63	\$1445.60	\$1481.78	\$1514.20	\$1602.77	\$1663.89	\$1826.37
Back Stop		SZT-20-111MA	1333.33	1370.75	1410.66	1430.63	1445.60	1481.78	1514.20	1602.77	1663.89	1826.37
Back Stop/ Forward Tilt		SZT-20-114MA	1398.26	1435.68	1475.59	1495.56	1510.53	1546.71	1579.13	1667.70	1728.82	1891.30
Lumbar Adjustment - Knit Back w/Plastic Base												
Pneumatic		SZT 20-112MA	\$1481.96	\$1519.38	\$1559.29	\$1579.26	\$1594.23	\$1630.41	\$1662.83	\$1751.40	\$1812.52	\$1975.00
Back Stop		SZT-20-111MA	1481.96	1519.38	1559.29	1579.26	1594.23	1630.41	1662.83	1751.40	1812.52	1975.00
Back Stop/ Forward Tilt		SZT-20-114MA	1546.89	1584.31	1624.22	1644.19	1659.16	1695.34	1727.76	1816.33	1877.45	2039.93
Lumbar Adjustment - Upholstered Back Jacket w/Plastic Base												
Pneumatic		SZT 22-112MA	\$1456.82	\$1531.66	\$1611.48	\$1651.42	\$1681.36	\$1753.72	\$1818.56	\$1995.70	\$2117.94	\$2442.90
Back Stop		SZT-22-111MA	1456.82	1531.66	1611.48	1651.42	1681.36	1753.72	1818.56	1995.70	2117.94	2442.90
Back Stop/ Forward Tilt		SZT-22-114MA	1521.75	1596.59	1676.41	1716.35	1746.29	1818.65	1883.49	2060.63	2182.87	2507.83
PAL Back System - Mesh Back w/Plastic Base												
Pneumatic		SZT-20-122MA	\$1362.02	\$1399.44	\$1439.35	\$1459.32	\$1474.29	\$1510.47	\$1542.89	\$1631.46	\$1692.58	\$1855.06
Back Stop		SZT-20-121MA	1362.02	1399.44	1439.35	1459.32	1474.29	1510.47	1542.89	1631.46	1692.58	1855.06
Back Stop/ Forward Tilt		SZT-20-124MA	1426.95	1464.37	1504.28	1524.25	1539.22	1575.40	1607.82	1696.39	1757.51	1919.99
PAL Back System - Knit Back w/Plastic Base												
Pneumatic		SZT 20-122MA	\$1510.65	\$1548.07	\$1587.98	\$1607.95	\$1622.92	\$1659.10	\$1691.52	\$1780.09	\$1841.21	\$2003.69
Back Stop		SZT-20-121MA	1510.65	1548.07	1587.98	1607.95	1622.92	1659.10	1691.52	1780.09	1841.21	2003.69
Back Stop/ Forward Tilt		SZT-20-124MA	1575.58	1613.00	1652.91	1672.88	1687.85	1724.03	1756.45	1845.02	1906.14	2068.62
PAL Back System - Upholstered Back Jacket w/Plastic Base												
Pneumatic		SZT 22-122MA	\$1485.51	\$1560.35	\$1640.17	\$1680.11	\$1710.05	\$1782.41	\$1847.25	\$2024.39	\$2146.63	\$2471.59
Back Stop		SZT-22-121MA	1485.51	1560.35	1640.17	1680.11	1710.05	1782.41	1847.25	2024.39	2146.63	2471.59
Back Stop/ Forward Tilt		SZT-22-124MA	1550.44	1625.28	1705.10	1745.04	1774.98	1847.34	1912.18	2089.32	2211.56	2536.52

The following options require modification of the product number.

- Fixed seat
- Headrest
- Stain repellent
- Leather Seat with Mesh Back
- Leather Seat with Leather Upholstered Back Jacket
- Faux Leather Seat with Mesh Back
- Faux Leather Seat with Faux Leather Upholstered Back Jacket

- To specify, change the 10th digit from A to X; **Example:** SZT-20-102MX1
- To specify, change the 3rd digit from a T to an E; **Example:** SZE-22-102MA1 with headrest (add \$64.86 list)
- To specify, add P to end of the product number (add \$38.67 list)
- To specify, change the 4th digit to 1 and 5th digit to 0; **Example:** SZT-10-102MA5
- To specify, change the 4th digit to 1 and 5th digit to 1; **Example:** SZT-11-102MA5
- To specify, change the 4th digit to 3; **Example:** SZT-30-102MA5
- To specify, change the 4th and 5th digits to 33; **Example:** SZT-33-102MA5

NOTE: For available fabrics, refer to surfaces.haworth.com.

! OBSOLETE | September 2022
Pneumatic configurations have been obsolete.

Zody
Task Chair with Fixed Arms

Upholstered Gel Insert Seat	Adjustments	Number	①	Fabric Grade								Leather Grade A	Leather Grade B
				A	B	C	D	E	F	G	H		
No Lumbar Adjustment - Mesh Back w/Plastic Base													
Pneumatic		SZT-20-102EA		\$1327.10	\$1364.52	\$1404.43	\$1424.40	\$1439.37	\$1475.55	\$1507.97	\$1596.54	\$1657.66	\$1820.14
Back Stop		SZT-20-101EA		1327.10	1364.52	1404.43	1424.40	1439.37	1475.55	1507.97	1596.54	1657.66	1820.14
Back Stop/ Forward Tilt		SZT-20-104EA		1392.03	1429.45	1469.36	1489.33	1504.30	1540.48	1572.90	1661.47	1722.59	1885.07
No Lumbar Adjustment - Knit Back w/Plastic Base													
Pneumatic		SZT-20-102EA		\$1475.73	\$1513.15	\$1553.06	\$1573.03	\$1588.00	\$1624.18	\$1656.60	\$1745.17	\$1806.29	\$1968.77
Back Stop		SZT-20-101EA		1475.73	1513.15	1553.06	1573.03	1588.00	1624.18	1656.60	1745.17	1806.29	1968.77
Back Stop/ Forward Tilt		SZT-20-104EA		1540.66	1578.08	1617.99	1637.96	1652.93	1689.11	1721.53	1810.10	1871.22	2033.70
No Lumbar Adjustment - Upholstered Back Jacket w/Plastic Base													
Pneumatic		SZT-22-102EA		\$1450.59	\$1525.43	\$1605.25	\$1645.19	\$1675.13	\$1747.49	\$1812.33	\$1989.47	\$2111.71	\$2436.67
Back Stop		SZT-22-101EA		1450.59	1525.43	1605.25	1645.19	1675.13	1747.49	1812.33	1989.47	2111.71	2436.67
Back Stop/ Forward Tilt		SZT-22-104EA		1515.52	1590.36	1670.18	1710.12	1740.06	1812.42	1877.26	2054.40	2176.64	2501.60
Lumbar Adjustment - Mesh Back w/Plastic Base													
Pneumatic		SZT-20-112EA		\$1436.88	\$1474.30	\$1514.21	\$1534.18	\$1549.15	\$1585.33	\$1617.75	\$1706.32	\$1767.44	\$1929.92
Back Stop		SZT-20-111EA		1436.88	1474.30	1514.21	1534.18	1549.15	1585.33	1617.75	1706.32	1767.44	1929.92
Back Stop/ Forward Tilt		SZT-20-114EA		1501.81	1539.23	1579.14	1599.11	1614.08	1650.26	1682.68	1771.25	1832.37	1994.85
Lumbar Adjustment - Knit Back w/Plastic Base													
Pneumatic		SZT-20-112EA		\$1585.51	\$1622.93	\$1662.84	\$1682.81	\$1697.78	\$1733.96	\$1766.38	\$1854.95	\$1916.07	\$2078.55
Back Stop		SZT-20-111EA		1585.51	1622.93	1662.84	1682.81	1697.78	1733.96	1766.38	1854.95	1916.07	2078.55
Back Stop/ Forward Tilt		SZT-20-114EA		1650.44	1687.86	1727.77	1747.74	1762.71	1798.89	1831.31	1919.88	1981.00	2143.48
Lumbar Adjustment - Upholstered Back Jacket w/Plastic Base													
Pneumatic		SZT-22-112EA		1560.37	1635.21	1715.03	1754.97	1784.91	1857.27	1922.11	2099.25	2221.49	2546.45
Back Stop		SZT-22-111EA		1560.37	1635.21	1715.03	1754.97	1784.91	1857.27	1922.11	2099.25	2221.49	2546.45
Back Stop/ Forward Tilt		SZT-22-114EA		1625.30	1700.14	1779.96	1819.90	1849.84	1922.20	1987.04	2164.18	2286.42	2611.38
PAL Back System - Mesh Back w/Plastic Base													
Pneumatic		SZT-20-122EA		\$1465.57	\$1502.99	\$1542.90	\$1562.87	\$1577.84	\$1614.02	\$1646.44	\$1735.01	\$1796.13	\$1958.61
Back Stop		SZT-20-121EA		1465.57	1502.99	1542.90	1562.87	1577.84	1614.02	1646.44	1735.01	1796.13	1958.61
Back Stop/ Forward Tilt		SZT-20-124EA		1530.50	1567.92	1607.83	1627.80	1642.77	1678.95	1711.37	1799.94	1861.06	2023.54
PAL Back System - Knit Back w/Plastic Base													
Pneumatic		SZT-20-122EA		\$1614.20	\$1651.62	\$1691.53	\$1711.50	\$1726.47	\$1762.65	\$1795.07	\$1883.64	\$1944.76	\$2107.24
Back Stop		SZT-20-121EA		1614.20	1651.62	1691.53	1711.50	1726.47	1762.65	1795.07	1883.64	1944.76	2107.24
Back Stop/ Forward Tilt		SZT-20-124EA		1679.13	1716.55	1756.46	1776.43	1791.40	1827.58	1860.00	1948.57	2009.69	2172.17
PAL Back System - Upholstered Back Jacket w/Plastic Base													
Pneumatic		SZT-22-122EA		\$1589.06	\$1663.90	\$1743.72	\$1783.66	\$1813.60	\$1885.96	\$1950.80	\$2127.94	\$2250.18	\$2575.14
Back Stop		SZT-22-121EA		1589.06	1663.90	1743.72	1783.66	1813.60	1885.96	1950.80	2127.94	2250.18	2575.14
Back Stop/ Forward Tilt		SZT-22-124EA		1653.99	1728.83	1808.65	1848.59	1878.53	1950.89	2015.73	2192.87	2315.11	2640.07

The following options require modification of the product number.

- Fixed seat
- Headrest
- Stain repellent
- Leather Seat with Mesh Back
- Leather Seat with Leather Upholstered Back Jacket
- Faux Leather Seat with Mesh Back
- Faux Leather Seat with Faux Leather Upholstered Back Jacket

- To specify, change the 10th digit from A to X; **Example:** SZT-20-102EX1
- To specify, change the 3rd digit from a T to an E; **Example:** SZE-22-102EA1 with headrest (add \$64.86 list)
- To specify, add **P** to end of the product number (add \$38.67 list)
- To specify, change the 4th digit to 1 and 5th digit to 0; **Example:** SZT-10-102EA5
- To specify, change the 4th digit to 1 and 5th digit to 1; **Example:** SZT-11-102EA5
- To specify, change the 4th digit to 3; **Example:** SZT-30-102EA5
- To specify, change the 4th and 5th digits to 33; **Example:** SZT-33-102EA5

NOTE: For available fabrics, refer to surfaces.haworth.com.

This page intentionally blank

Zody

Task Chair without Arms



SZT-20-002MA1

Dimensions*

- *SH: 16-21" (406mm-533mm)
- H: 38-43" (965mm-1092mm)
- D: 29" (737mm)
- W: 29" (737mm)
- *SW: 19.25" (489mm)
- *SD: 16-19" (406mm-483mm)

Low position seat height:
14-17" (356mm-432mm)

* All measurements taken with the BIFMA chair measuring device.

Trim Color ¹	Headrest Color*	
	Black	Smoke
Black (TR-F)	•	
Smoke (TR-E)		•
Snow (TR-UFM)		•

*Not specifiable.

¹Plastic base option will default all metal trim to Black (TR-F).

Features

- Back: Knit, mesh, or mesh back with upholstered back jacket.
- Seat: Standard upholstered with foam or optional foam with Technogel[®] Soft Lite gel insert.
- Seat Type: Standard adjustable [3" (76mm) range] or optional fixed.
- Base: Standard Plastic painted five-star base or optional painted aluminum or polished aluminum.
 - Plastic base available in Black.
 - Aluminum base available with painted Black, Metallic Silver, Metallic Champagne, or optional Polished Aluminum.
- Mechanism: Balanced 3-point tilt; standard tilt tension.
- Height adjustment: Pneumatic or low-position pneumatic.
- Optional Back Stop: Tilt stop in 6 positions.
- Optional Back Stop with Forward Tilt; Seat tilts 5° downward from initial position.
- Optional Asymmetrical Lumbar Adjustment: 4" (102mm) height adjustment; support level can be adjusted independently for right or left hand side of users body. Optional PAL Back System: Passive pelvic support
- Casters: Hard or soft casters in black only.
- COM yardage / COL square footage:
 - Mesh back model: 0.75/10
 - Mesh back/upholstered back jacket: 1.5/18

NOTE: When specifying fabric or leather back jacket; must also specify mesh surface color for outside back.

Upcharge for mixed grade surfaces, refer to the electronic design and specification tools.

To Order with Fabric or Leather Upholstered Back Jacket Specify:

1) Product number, including:

1 Base/Caster Option:

Aluminum Base

- 1 Aluminum Base, Hard Caster, add **\$35.64** to list
- 2 Aluminum Base, Soft Caster, add **\$80.64** to list
- 3 Aluminum Low Base, Hard Caster, add **\$35.64** to list
- 4 Aluminum Low Base, Soft Caster, add **\$80.64** to list

Plastic Base

- 5 Plastic Std. Base, Hard Caster
- 6 Plastic Std. Base, Soft Caster, add **\$45.00** to list

- 2) Fabric surface and color (seat).
- 3) Mesh surface color (back).
- 4) Fabric surface and color (back jacket).
- 5) Trim color for frame. (Add **\$61.00** list for Snow.)
- 6) Trim color for base. (Add **\$208.32** list for polished aluminum.)

To Order with Knit or Mesh Back Specify:

1) Product number, including:

1 Base/Caster Option:

Aluminum Base

- 1 Aluminum Base, Hard Caster, add **\$35.64** to list
- 2 Aluminum Base, Soft Caster, add **\$80.64** to list
- 3 Aluminum Low Base, Hard Caster, add **\$35.64** to list
- 4 Aluminum Low Base, Soft Caster, add **\$80.64** to list

Plastic Base

- 5 Plastic Std. Base, Hard Caster
- 6 Plastic Std. Base, Soft Caster, add **\$45.00** to list

- 2) Fabric surface and color (seat).
- 3) Knit or Mesh surface and color (back).
- 4) Trim color for frame. (Add **\$61.00** list for Snow.)
- 5) Trim color for base. (Add **\$208.32** list for polished aluminum.)

Zody

Task Chair without Arms

 **OBSOLETE** | September 2022
Pneumatic configurations have been obsolete.

Upholstered		Fabric Grade										Leather	Leather
Foam Seat	Adjustments	Number	①	A	B	C	D	E	F	G	H	Grade A	Grade B
No Lumbar Adjustment - Mesh Back w/Plastic Base													
Pneumatic	SZT-20-002MA	1085.08	1122.50	1162.41	1182.38	1197.35	1233.53	1265.95	1354.52	1415.64	1578.12	1415.64	1578.12
Back Stop	SZT-20-001MA	1085.08	1122.50	1162.41	1182.38	1197.35	1233.53	1265.95	1354.52	1415.64	1578.12	1415.64	1578.12
Back Stop/ Forward Tilt	SZT-20-004MA	1150.01	1187.43	1227.34	1247.31	1262.28	1298.46	1330.88	1419.45	1480.57	1643.05	1480.57	1643.05
No Lumbar Adjustment - Knit Back w/Plastic Base													
Pneumatic	SZT-20-002MA	1233.71	1271.13	1311.04	1331.01	1345.98	1382.16	1414.58	1503.15	1564.27	1726.75	1564.27	1726.75
Back Stop	SZT-20-001MA	1233.71	1271.13	1311.04	1331.01	1345.98	1382.16	1414.58	1503.15	1564.27	1726.75	1564.27	1726.75
Back Stop/ Forward Tilt	SZT-20-004MA	1298.64	1336.06	1375.97	1395.94	1410.91	1447.09	1479.51	1568.08	1629.20	1791.68	1629.20	1791.68
No Lumbar Adjustment - Upholstered Back Jacket w/Plastic Base													
Pneumatic	SZT-22-002MA	1208.57	1283.41	1363.23	1403.17	1433.11	1505.47	1570.31	1747.45	1869.69	2194.65	1869.69	2194.65
Back Stop	SZT-22-001MA	1208.57	1283.41	1363.23	1403.17	1433.11	1505.47	1570.31	1747.45	1869.69	2194.65	1869.69	2194.65
Back Stop/ Forward Tilt	SZT-22-004MA	1273.50	1348.34	1428.16	1468.10	1498.04	1570.40	1635.24	1812.38	1934.62	2259.58	1934.62	2259.58
Lumbar Adjustment - Mesh Back w/Plastic Base													
Pneumatic	SZT-20-012MA	1194.86	1232.28	1272.19	1292.16	1307.13	1343.31	1375.73	1464.30	1525.42	1687.90	1525.42	1687.90
Back Stop	SZT-20-011MA	1194.86	1232.28	1272.19	1292.16	1307.13	1343.31	1375.73	1464.30	1525.42	1687.90	1525.42	1687.90
Back Stop/ Forward Tilt	SZT-20-014MA	1259.79	1297.21	1337.12	1357.09	1372.06	1408.24	1440.66	1529.23	1590.35	1752.83	1590.35	1752.83
Lumbar Adjustment - Knit Back w/Plastic Base													
Pneumatic	SZT-20-012MA	1343.49	1380.91	1420.82	1440.79	1455.76	1491.94	1524.36	1612.93	1674.05	1836.53	1674.05	1836.53
Back Stop	SZT-20-011MA	1343.49	1380.91	1420.82	1440.79	1455.76	1491.94	1524.36	1612.93	1674.05	1836.53	1674.05	1836.53
Back Stop/ Forward Tilt	SZT-20-014MA	1408.42	1445.84	1485.75	1505.72	1520.69	1556.87	1589.29	1677.86	1738.98	1901.46	1738.98	1901.46
Lumbar Adjustment - Upholstered Back Jacket w/Plastic Base													
Pneumatic	SZT-22-012MA	1318.35	1393.19	1473.01	1512.95	1542.89	1615.25	1680.09	1857.23	1979.47	2304.43	1979.47	2304.43
Back Stop	SZT-22-011MA	1318.35	1393.19	1473.01	1512.95	1542.89	1615.25	1680.09	1857.23	1979.47	2304.43	1979.47	2304.43
Back Stop/ Forward Tilt	SZT-22-014MA	1383.28	1458.12	1537.94	1577.88	1607.82	1680.18	1745.02	1922.16	2044.40	2369.36	2044.40	2369.36
PAL Back System - Mesh Back w/Plastic Base													
Pneumatic	SZT-20-022MA	1223.55	1260.97	1300.88	1320.85	1335.82	1372.00	1404.42	1492.99	1554.11	1716.59	1554.11	1716.59
Back Stop	SZT-20-021MA	1223.55	1260.97	1300.88	1320.85	1335.82	1372.00	1404.42	1492.99	1554.11	1716.59	1554.11	1716.59
Back Stop/ Forward Tilt	SZT-20-024MA	1288.48	1325.90	1365.81	1385.78	1400.75	1436.93	1469.35	1557.92	1619.04	1781.52	1619.04	1781.52
PAL Back System - Knit Back w/Plastic Base													
Pneumatic	SZT-20-022MA	1372.18	1409.60	1449.51	1469.48	1484.45	1520.63	1553.05	1641.62	1702.74	1865.22	1702.74	1865.22
Back Stop	SZT-20-021MA	1372.18	1409.60	1449.51	1469.48	1484.45	1520.63	1553.05	1641.62	1702.74	1865.22	1702.74	1865.22
Back Stop/ Forward Tilt	SZT-20-024MA	1437.11	1474.53	1514.44	1534.41	1549.38	1585.56	1617.98	1706.55	1767.67	1930.15	1767.67	1930.15
PAL Back System - Upholstered Back Jacket w/Plastic Base													
Pneumatic	SZT-22-022MA	1347.04	1421.88	1501.70	1541.64	1571.58	1643.94	1708.78	1885.92	2008.16	2333.12	2008.16	2333.12
Back Stop	SZT-22-021MA	1347.04	1421.88	1501.70	1541.64	1571.58	1643.94	1708.78	1885.92	2008.16	2333.12	2008.16	2333.12
Back Stop/ Forward Tilt	SZT-22-024MA	1411.97	1486.81	1566.63	1606.57	1636.51	1708.87	1773.71	1950.85	2073.09	2398.05	2073.09	2398.05

The following options require modification of the product number.

- Fixed seat
- Headrest
- Stain repellent
- Leather Seat with Mesh Back
- Leather Seat with Leather Upholstered Back Jacket
- Faux Leather Seat with Mesh Back
- Faux Leather Seat with Faux Leather Upholstered Back Jacket

- To specify, change the 10th digit from A to X; **Example:** SZT-20-002MX1
- To specify, change the 3rd digit from a T to an E; **Example:** SZE-22-002MA1 with headrest (add \$64.86 list)
- To specify, add P to end of the product number (add \$38.67 list)
- To specify, change the 4th digit to 1 and 5th digit to 0; **Example:** SZT-10-002MA5
- To specify, change the 4th digit to 1 and 5th digit to 1; **Example:** SZT-11-002MA5
- To specify, change the 4th digit to 3; **Example:** SZT-30-002MA5
- To specify, change the 4th and 5th digits to 33; **Example:** SZT-33-002MA5

NOTE: For available fabrics, refer to surfaces.haworth.com.

⚠️ OBSOLETE | September 2022

Pneumatic configurations have been obsolete.

Upholstered Gel Insert Seat	Adjustments	Number	Fabric Grade								Leather Grade A	Leather Grade B
			A	B	C	D	E	F	G	H		
No Lumbar Adjustment - Mesh Back w/Plastic Base												
Pneumatic		SZT-20-002EA	\$1188.63	\$1226.05	\$1265.96	\$1285.93	\$1300.90	\$1337.08	\$1369.50	\$1458.07	\$1519.19	\$1681.67
Back Stop		SZT-20-001EA	1188.63	1226.05	1265.96	1285.93	1300.90	1337.08	1369.50	1458.07	1519.19	1681.67
Back Stop/ Forward Tilt		SZT-20-004EA	1253.56	1290.98	1330.89	1350.86	1365.83	1402.01	1434.43	1523.00	1584.12	1746.60
No Lumbar Adjustment - Knit Back w/Plastic Base												
Pneumatic		SZT-20-002EA	\$1337.26	\$1374.68	\$1414.59	\$1434.56	\$1449.53	\$1485.71	\$1518.13	\$1606.70	\$1667.82	\$1830.30
Back Stop		SZT-20-001EA	1337.26	1374.68	1414.59	1434.56	1449.53	1485.71	1518.13	1606.70	1667.82	1830.30
Back Stop/ Forward Tilt		SZT-20-004EA	1402.19	1439.61	1479.52	1499.49	1514.46	1550.64	1583.06	1671.63	1732.75	1895.23
No Lumbar Adjustment - Upholstered Back Jacket w/Plastic Base												
Pneumatic		SZT-22-002EA	\$1312.12	\$1386.96	\$1466.78	\$1506.72	\$1536.66	\$1609.02	\$1673.86	\$1851.00	\$1973.24	\$2298.20
Back Stop		SZT-22-001EA	1312.12	1386.96	1466.78	1506.72	1536.66	1609.02	1673.86	1851.00	1973.24	2298.20
Back Stop/ Forward Tilt		SZT-22-004EA	1377.05	1451.89	1531.71	1571.65	1601.59	1673.95	1738.79	1915.93	2038.17	2363.13
Lumbar Adjustment - Mesh Back w/Plastic Base												
Pneumatic		SZT-20-012EA	\$1298.41	\$1335.83	\$1375.74	\$1395.71	\$1410.68	\$1446.86	\$1479.28	\$1567.85	\$1628.97	\$1791.45
Back Stop		SZT-20-011EA	1298.41	1335.83	1375.74	1395.71	1410.68	1446.86	1479.28	1567.85	1628.97	1791.45
Back Stop/ Forward Tilt		SZT-20-014EA	1363.34	1400.76	1440.67	1460.64	1475.61	1511.79	1544.21	1632.78	1693.90	1856.38
Lumbar Adjustment - Knit Back w/Plastic Base												
Pneumatic		SZT-20-012EA	\$1447.04	\$1484.46	\$1524.37	\$1544.34	\$1559.31	\$1595.49	\$1627.91	\$1716.48	\$1777.60	\$1940.08
Back Stop		SZT-20-011EA	1447.04	1484.46	1524.37	1544.34	1559.31	1595.49	1627.91	1716.48	1777.60	1940.08
Back Stop/ Forward Tilt		SZT-20-014EA	1511.97	1549.39	1589.30	1609.27	1624.24	1660.42	1692.84	1781.41	1842.53	2005.01
Lumbar Adjustment - Upholstered Back Jacket w/Plastic Base												
Pneumatic		SZT-22-012EA	\$1421.90	\$1496.74	\$1576.56	\$1616.50	\$1646.44	\$1718.80	\$1783.64	\$1960.78	\$2083.02	\$2407.98
Back Stop		SZT-22-011EA	1421.90	1496.74	1576.56	1616.50	1646.44	1718.80	1783.64	1960.78	2083.02	2407.98
Back Stop/ Forward Tilt		SZT-22-014EA	1486.83	1561.67	1641.49	1681.43	1711.37	1783.73	1848.57	2025.71	2147.95	2472.91
PAL Back System - Mesh Back w/Plastic Base												
Pneumatic		SZT-20-022EA	\$1327.10	\$1364.52	\$1404.43	\$1424.40	\$1439.37	\$1475.55	\$1507.97	\$1596.54	\$1657.66	\$1820.14
Back Stop		SZT-20-021EA	1327.10	1364.52	1404.43	1424.40	1439.37	1475.55	1507.97	1596.54	1657.66	1820.14
Back Stop/ Forward Tilt		SZT-20-024EA	1392.03	1429.45	1469.36	1489.33	1504.30	1540.48	1572.90	1661.47	1722.59	1885.07
PAL Back System - Knit Back w/Plastic Base												
Pneumatic		SZT-20-022EA	\$1475.73	\$1513.15	\$1553.06	\$1573.03	\$1588.00	\$1624.18	\$1656.60	\$1745.17	\$1806.29	\$1968.77
Back Stop		SZT-20-021EA	1475.73	1513.15	1553.06	1573.03	1588.00	1624.18	1656.60	1745.17	1806.29	1968.77
Back Stop/ Forward Tilt		SZT-20-024EA	1540.66	1578.08	1617.99	1637.96	1652.93	1689.11	1721.53	1810.10	1871.22	2033.70
PAL Back System - Upholstered Back Jacket w/Plastic Base												
Pneumatic		SZT-22-022EA	\$1450.59	\$1525.43	\$1605.25	\$1645.19	\$1675.13	\$1747.49	\$1812.33	\$1989.47	\$2111.71	\$2436.67
Back Stop		SZT-22-021EA	1450.59	1525.43	1605.25	1645.19	1675.13	1747.49	1812.33	1989.47	2111.71	2436.67
Back Stop/ Forward Tilt		SZT-22-024EA	1515.52	1590.36	1670.18	1710.12	1740.06	1812.42	1877.26	2054.40	2176.64	2501.60

The following options require modification of the product number.

- Fixed seat
- Headrest
- Stain repellent
- Leather Seat with Mesh Back
- Leather Seat with Leather Upholstered Back Jacket
- Faux Leather Seat with Mesh Back
- Faux Leather Seat with Faux Leather Upholstered Back Jacket

- To specify, change the 10th digit from A to X; **Example:** SZT-20-002EX1
- To specify, change the 3rd digit from a T to an E; **Example:** SZE-22-002EA1 with headrest (add \$64.86 list)
- To specify, add **P** to end of the product number (add \$38.67 list)
- To specify, change the 4th digit to 1 and 5th digit to 0; **Example:** SZT-10-002EA5
- To specify, change the 4th digit to 1 and 5th digit to 1; **Example:** SZT-11-002EA5
- To specify, change the 4th digit to 3; **Example:** SZT-30-002EA5
- To specify, change the 4th and 5th digits to 33; **Example:** SZT-33-002EA5

NOTE: For available fabrics, refer to surfaces.haworth.com.

This page intentionally blank

Zody

Task Stool with 4D Arms



SZTC-20-702MA1

Dimensions*

- *SH: 21.5-29" (546mm-737mm)
- H: 43-51" (1092mm-1295mm)
- D: 29" (737mm)
- W: 29" (737mm)
- *SW: 19.25" (489mm)
- *SD: 16-19" (406mm-483mm)
- *AH: 6.8-10.8" (173mm-274mm)

* All measurements taken with the BIFMA chair measuring device.

Features

- Back: Knit, mesh, or mesh back with upholstered back jacket.
- Seat: Standard upholstered with foam or optional foam with Technogel® Soft Lite gel insert.
- Seat Type: Standard adjustable [3"(76mm) range] or optional fixed.
- Base: Standard Plastic painted five-star base or optional painted aluminum or polished aluminum. –Plastic base available in Black. –Aluminum base available with painted Black, Metallic Silver, Metallic Champagne, or optional Polished Aluminum.
- Arms: 4D with soft arm caps. See matrix for default colors.
- Mechanism: Balanced 3-point tilt; standard tilt tension.
- Height adjustment: Pneumatic.
- Optional Back Stop: Tilt stop in 6 positions.
- Optional Asymmetrical Lumbar Adjustment: 4"(102mm) height adjustment; support level can be adjusted independently for right or left hand side of users body. Optional PAL Back System: Passive pelvic support.
- Casters: Hard or soft casters in black only.
- COM yardage / COL square footage:
Mesh back model: .75/10
Mesh back/upholstered back jacket: 1.5/18

NOTE: When specifying fabric or leather back jacket; must also specify mesh surface color for outside back.

Upcharge for mixed grade surfaces, refer to the electronic design and specification tools.

To Order with Fabric or Leather Upholstered Back Jacket Specify:

1) Product number, including:

1 Base/Caster Option:

Aluminum Base

- 1 Aluminum Base, Hard Caster, add **\$35.64** to list
- 2 Aluminum Base, Soft Caster, add **\$80.64** to list

Plastic Base

- 5 Plastic Std. Base, Hard Caster
- 6 Plastic Std. Base, Soft Caster, add **\$45.00** to list

- 2) Fabric surface and color (seat).
- 3) Mesh surface color (back).
- 4) Fabric surface and color (back jacket).
- 5) Trim color for frame. (Add **\$61.00** list for Snow.)
- 6) Trim color for base/arms. (Add **\$208.32** list for polished aluminum.)

To Order with Knit or Mesh Back Specify:

1) Product number, including:

1 Base/Caster Option:

Aluminum Base

- 1 Aluminum Base, Hard Caster, add **\$35.64** to list
- 2 Aluminum Base, Soft Caster, add **\$80.64** to list

Plastic Base

- 5 Plastic Std. Base, Hard Caster
- 6 Plastic Std. Base, Soft Caster, add **\$45.00** to list

- 2) Fabric surface and color (seat).
- 3) Knit or Mesh surface and color (back).
- 4) Trim color for frame. (Add **\$61.00** list for Snow.)
- 5) Trim color for base/arms. (Add **\$208.32** list for polished aluminum.)

Trim Color ¹	Arm Cap Color*	
	Black	Smoke
Black (TR-F)	•	
Smoke (TR-E)		•
Snow (TR-UFM)		•

*Not specifiable.

¹Plastic base option will default all metal trim to Black (TR-F).

Zody

Task Stool with 4D Arms

 **OBSOLETE** | September 2022
Pneumatic configurations have been obsolete.

Upholstered Foam Seat	Adjustments	Number	①	Fabric Grade								Leather Grade A	Leather Grade B
				A	B	C	D	E	F	G	H		
No Lumbar Adjustment - Mesh Back w/Plastic Base													
Pneumatic		SZTC-20-702MA		\$1624.94	\$1662.36	\$1702.27	\$1722.24	\$1737.21	\$1773.39	\$1805.81	\$1894.38	\$1955.50	\$2117.98
Back Stop		SZTC-20-701MA		1624.94	1662.36	1702.27	1722.24	1737.21	1773.39	1805.81	1894.38	1955.50	2117.98
No Lumbar Adjustment - Knit Back w/Plastic Base													
Pneumatic		SZTC-20-702MA		\$1773.57	\$1810.99	\$1850.90	\$1870.87	\$1885.84	\$1922.02	\$1954.44	\$2043.01	\$2104.13	\$2266.61
Back Stop		SZTC-20-701MA		1773.57	1810.99	1850.90	1870.87	1885.84	1922.02	1954.44	2043.01	2104.13	2266.61
No Lumbar Adjustment - Upholstered Back Jacket w/Plastic Base													
Pneumatic		SZTC-22-702MA		\$1748.43	\$1823.27	\$1903.09	\$1943.03	\$1972.97	\$2045.33	\$2110.17	\$2287.31	\$2409.55	\$2734.51
Back Stop		SZTC-22-701MA		1748.43	1823.27	1903.09	1943.03	1972.97	2045.33	2110.17	2287.31	2409.55	2734.51
Lumbar Adjustment - Mesh Back w/Plastic Base													
Pneumatic		SZTC-20-712MA		\$1734.72	\$1772.14	\$1812.05	\$1832.02	\$1846.99	\$1883.17	\$1915.59	\$2004.16	\$2065.28	\$2227.76
Back Stop		SZTC-20-711MA		1734.72	1772.14	1812.05	1832.02	1846.99	1883.17	1915.59	2004.16	2065.28	2227.76
Lumbar Adjustment - Knit Back w/Plastic Base													
Pneumatic		SZTC-20-712MA		\$1883.35	\$1920.77	\$1960.68	\$1980.65	\$1995.62	\$2031.80	\$2064.22	\$2152.79	\$2213.91	\$2376.39
Back Stop		SZTC-20-711MA		1883.35	1920.77	1960.68	1980.65	1995.62	2031.80	2064.22	2152.79	2213.91	2376.39
Lumbar Adjustment - Upholstered Back Jacket w/Plastic Base													
Pneumatic		SZTC-22-712MA		\$1858.21	\$1933.05	\$2012.87	\$2052.81	\$2082.75	\$2155.11	\$2219.95	\$2397.09	\$2519.33	\$2844.29
Back Stop		SZTC-22-711MA		1858.21	1933.05	2012.87	2052.81	2082.75	2155.11	2219.95	2397.09	2519.33	2844.29
PAL Back System - Mesh Back w/Plastic Base													
Pneumatic		SZTC-20-722MA		\$1763.41	\$1800.83	\$1840.74	\$1860.71	\$1875.68	\$1911.86	\$1944.28	\$2032.85	\$2093.97	\$2256.45
Back Stop		SZTC-20-721MA		1763.41	1800.83	1840.74	1860.71	1875.68	1911.86	1944.28	2032.85	2093.97	2256.45
PAL Back System - Knit Back w/Plastic Base													
Pneumatic		SZTC-20-722MA		\$1912.04	\$1949.46	\$1989.37	\$2009.34	\$2024.31	\$2060.49	\$2092.91	\$2181.48	\$2242.60	\$2405.08
Back Stop		SZTC-20-721MA		1912.04	1949.46	1989.37	2009.34	2024.31	2060.49	2092.91	2181.48	2242.60	2405.08
PAL Back System - Upholstered Back Jacket w/Plastic Base													
Pneumatic		SZTC-22-722MA		\$1886.90	\$1961.74	\$2041.56	\$2081.50	\$2111.44	\$2183.80	\$2248.64	\$2425.78	\$2548.02	\$2872.98
Back Stop		SZTC-22-721MA		1886.90	1961.74	2041.56	2081.50	2111.44	2183.80	2248.64	2425.78	2548.02	2872.98

The following options require modification of the product number.

- Fixed seat
- Stain repellent
- Leather Seat with Mesh Back
- Leather Seat with Leather Upholstered Back Jacket
- Faux Leather Seat with Mesh Back
- Faux Leather Seat with Faux Leather Upholstered Back Jacket

- To specify, change the 11th digit from A to X; **Example:** SZTC-20-702MX1
- To specify, add **P** to end of the product number (add **\$38.67** list); **Example:** SZTC-20-712MA1P
- To specify, change the 5th digit to **1** and 6th digit to **0**; **Example:** SZTC-10-702MA5
- To specify, change the 5th digit to **1** and 6th digit to **1**; **Example:** SZTC-11-702MA5
- To specify, change the 5th digit to **3**; **Example:** SZTC-30-702MA5
- To specify, change the 5th and 6th digits to **33**; **Example:** SZTC-33-702MA5

NOTE: For available fabrics, refer to surfaces.haworth.com.

! OBSOLETE | September 2022
Pneumatic configurations have been obsolete.

Zody
Task Stool with 4D Arms

Upholstered Gel Insert Seat	Adjustments	Number	①	Fabric Grade								Leather Grade A	Leather Grade B
				A	B	C	D	E	F	G	H		
No Lumbar Adjustment - Mesh Back w/Plastic Base													
Pneumatic	SZTC-20-702EA			\$1728.49	\$1765.91	\$1805.82	\$1825.79	\$1840.76	\$1876.94	\$1909.36	\$1997.93	\$2059.05	\$2221.53
Back Stop	SZTC-20-701EA			1728.49	1765.91	1805.82	1825.79	1840.76	1876.94	1909.36	1997.93	2059.05	2221.53
No Lumbar Adjustment - Knit Back w/Plastic Base													
Pneumatic	SZTC-20-702EA			\$1877.12	\$1914.54	\$1954.45	\$1974.42	\$1989.39	\$2025.57	\$2057.99	\$2146.56	\$2207.68	\$2370.16
Back Stop	SZTC-20-701EA			1877.12	1914.54	1954.45	1974.42	1989.39	2025.57	2057.99	2146.56	2207.68	2370.16
No Lumbar Adjustment - Upholstered Back Jacket w/Plastic Base													
Pneumatic	SZTC-22-702EA			\$1851.98	\$1926.82	\$2006.64	\$2046.58	\$2076.52	\$2148.88	\$2213.72	\$2390.86	\$2513.10	\$2838.06
Back Stop	SZTC-22-701EA			1851.98	1926.82	2006.64	2046.58	2076.52	2148.88	2213.72	2390.86	2513.10	2838.06
Lumbar Adjustment - Mesh Back w/Plastic Base													
Pneumatic	SZTC-20-712EA			\$1838.27	\$1875.69	\$1915.60	\$1935.57	\$1950.54	\$1986.72	\$2019.14	\$2107.71	\$2168.83	\$2331.31
Back Stop	SZTC-20-711EA			1838.27	1875.69	1915.60	1935.57	1950.54	1986.72	2019.14	2107.71	2168.83	2331.31
Lumbar Adjustment - Knit Back w/Plastic Base													
Pneumatic	SZTC-20-712EA			\$1986.90	\$2024.32	\$2064.23	\$2084.20	\$2099.17	\$2135.35	\$2167.77	\$2256.34	\$2317.46	\$2479.94
Back Stop	SZTC-20-711EA			1986.90	2024.32	2064.23	2084.20	2099.17	2135.35	2167.77	2256.34	2317.46	2479.94
Lumbar Adjustment - Upholstered Back Jacket w/Plastic Base													
Pneumatic	SZTC-22-712EA			\$1961.76	\$2036.60	\$2116.42	\$2156.36	\$2186.30	\$2258.66	\$2323.50	\$2500.64	\$2622.88	\$2947.84
Back Stop	SZTC-22-711EA			1961.76	2036.60	2116.42	2156.36	2186.30	2258.66	2323.50	2500.64	2622.88	2947.84
PAL Back System - Mesh Back w/Plastic Base													
Pneumatic	SZTC-20-722EA			\$1866.96	\$1904.38	\$1944.29	\$1964.26	\$1979.23	\$2015.41	\$2047.83	\$2136.40	\$2197.52	\$2360.00
Back Stop	SZTC-20-721EA			1866.96	1904.38	1944.29	1964.26	1979.23	2015.41	2047.83	2136.40	2197.52	2360.00
PAL Back System - Knit Back w/Plastic Base													
Pneumatic	SZTC-20-722EA			\$2015.59	\$2053.01	\$2092.92	\$2112.89	\$2127.86	\$2164.04	\$2196.46	\$2285.03	\$2346.15	\$2508.63
Back Stop	SZTC-20-721EA			2015.59	2053.01	2092.92	2112.89	2127.86	2164.04	2196.46	2285.03	2346.15	2508.63
PAL Back System - Upholstered Back Jacket w/Plastic Base													
Pneumatic	SZTC-22-722EA			\$1990.45	\$2065.29	\$2145.11	\$2185.05	\$2214.99	\$2287.35	\$2352.19	\$2529.33	\$2651.57	\$2976.53
Back Stop	SZTC-22-721EA			1990.45	2065.29	2145.11	2185.05	2214.99	2287.35	2352.19	2529.33	2651.57	2976.53

The following options require modification of the product number.

- Fixed seat
- Stain repellent
- Leather Seat with Mesh Back
- Leather Seat with Leather Upholstered Back Jacket
- Faux Leather Seat with Mesh Back
- Faux Leather Seat with Faux Leather Upholstered Back Jacket

- To specify, change the 11th digit from A to X; **Example:** SZTC-20-702EX1
- To specify, add P to end of the product number (add \$38.67 list); **Example:** SZTC-20-702EA1P
- To specify, change the 5th digit to 1 and 6th digit to 0; **Example:** SZTC-10-702EA5
- To specify, change the 5th digit to 1 and 6th digit to 1; **Example:** SZTC-11-702EA5
- To specify, change the 5th digit to 3; **Example:** SZTC-30-702EA5
- To specify, change the 5th and 6th digits to 33; **Example:** SZTC-33-702EA5

NOTE: For available fabrics, refer to surfaces.haworth.com.

This page intentionally blank

Zody

Task Stool with Height Adjustable Arms



SZTC-20-402MA1

Dimensions*

- *SH: 21.5-29" (546mm-737mm)
- H: 43-51" (1092mm-1295mm)
- D: 29" (737mm)
- W: 29" (737mm)
- *SW: 19.25" (489mm)
- *SD: 16-19" (406mm-483mm)
- *AH: 6.8-10.8" (173mm-274mm)

* All measurements taken with the BIFMA chair measuring device.

Features

- Back: Knit, mesh, or mesh back with upholstered back jacket.
- Seat: Standard upholstered with foam or optional foam with Technogel® Soft Lite gel insert.
- Seat Type: Standard adjustable [3"(76mm) range] or optional fixed.
- Base: Standard Plastic painted five-star base or optional painted aluminum or polished aluminum.
 - Plastic base available in Black.
 - Aluminum base available with painted Black, Metallic Silver, Metallic Champagne, or optional Polished Aluminum.
- Arms: Height-adjustable with soft arm caps. See matrix for default colors.
- Mechanism: Balanced 3-point tilt; standard tilt tension.
- Height adjustment: Pneumatic.
- Optional Back Stop: Tilt stop in 6 positions.
- Optional Asymmetrical Lumbar Adjustment: 4"(102mm) height adjustment; support level can be adjusted independently for right or left hand side of users body. Optional PAL Back System: Passive pelvic support.
- Casters: Hard or soft casters in black only.
- COM yardage / COL square footage:
 - Mesh back model: 0.75/10
 - Mesh back/upholstered back jacket: 1.5/18

NOTE: When specifying fabric or leather back jacket; must also specify mesh surface color for outside back.

Upcharge for mixed grade surfaces, refer to the electronic design and specification tools.

To Order with Fabric or Leather Upholstered Back Jacket Specify:

1) Product number, including:

1 Base/Caster Option:

Aluminum Base

- 1 Aluminum Base, Hard Caster, add **\$35.64** to list
- 2 Aluminum Base, Soft Caster, add **\$80.64** to list

Plastic Base

- 5 Plastic Std. Base, Hard Caster
- 6 Plastic Std. Base, Soft Caster, add **\$45.00** to list

- 2) Fabric surface and color (seat).
- 3) Mesh surface color (back).
- 4) Fabric surface and color (back jacket).
- 5) Trim color for frame. (Add **\$61.00** list for Snow.)
- 6) Trim color for base/arms. (Add **\$208.32** list for polished aluminum.)

To Order with Knit or Mesh Back Specify:

1) Product number, including:

1 Base/Caster Option:

Aluminum Base

- 1 Aluminum Base, Hard Caster, add **\$35.64** to list
- 2 Aluminum Base, Soft Caster, add **\$80.64** to list

Plastic Base

- 5 Plastic Std. Base, Hard Caster
- 6 Plastic Std. Base, Soft Caster, add **\$45.00** to list

- 2) Fabric surface and color (seat).
- 3) Knit or Mesh surface and color (back).
- 4) Trim color for frame. (Add **\$61.00** list for Snow.)
- 5) Trim color for base/arms. (Add **\$208.32** list for polished aluminum.)

Trim Color ¹	Arm Cap Color*	
	Black	Smoke
Black (TR-F)	•	
Smoke (TR-E)		•
Snow (TR-UFM)		•

*Not specifiable.

¹Plastic base option will default all metal trim to Black (TR-F).

Zody

Task Stool with Height Adjustable Arms

 **OBSOLETE** | September 2022
Pneumatic configurations have been obsolete.

Upholstered Foam Seat	Adjustments	Number	①	Fabric Grade								Leather Grade A	Leather Grade B
				A	B	C	D	E	F	G	H		
No Lumbar Adjustment - Mesh w/Plastic Base													
Pneumatic		SZTC 20-402MA		\$1583.77	\$1621.19	\$1661.10	\$1681.07	\$1696.04	\$1732.22	\$1764.64	\$1853.21	\$1914.33	\$2076.81
Back Stop		SZTC-20-401MA		1583.77	1621.19	1661.10	1681.07	1696.04	1732.22	1764.64	1853.21	1914.33	2076.81
No Lumbar Adjustment - Knit w/Plastic Base													
Pneumatic		SZTC 20-402MA		\$1732.40	\$1769.82	\$1809.73	\$1829.70	\$1844.67	\$1880.85	\$1913.27	\$2001.84	\$2062.96	\$2225.44
Back Stop		SZTC-20-401MA		1732.40	1769.82	1809.73	1829.70	1844.67	1880.85	1913.27	2001.84	2062.96	2225.44
No Lumbar Adjustment - Upholstered Back Jacket w/Plastic Base													
Pneumatic		SZTC 22-402MA		\$1707.26	\$1782.10	\$1861.92	\$1901.86	\$1931.80	\$2004.16	\$2069.00	\$2246.14	\$2368.38	\$2693.34
Back Stop		SZTC-22-401MA		1707.26	1782.10	1861.92	1901.86	1931.80	2004.16	2069.00	2246.14	2368.38	2693.34
Lumbar Adjustment - Mesh w/Plastic Base													
Pneumatic		SZTC 20-412MA		\$1693.55	\$1730.97	\$1770.88	\$1790.85	\$1805.82	\$1842.00	\$1874.42	\$1962.99	\$2024.11	\$2186.59
Back Stop		SZTC-20-411MA		1693.55	1730.97	1770.88	1790.85	1805.82	1842.00	1874.42	1962.99	2024.11	2186.59
Lumbar Adjustment - Knit w/Plastic Base													
Pneumatic		SZTC-20-412MA		\$1842.18	\$1879.60	\$1919.51	\$1939.48	\$1954.45	\$1990.63	\$2023.05	\$2111.62	\$2172.74	\$2335.22
Back Stop		SZTC-20-411MA		1842.18	1879.60	1919.51	1939.48	1954.45	1990.63	2023.05	2111.62	2172.74	2335.22
Lumbar Adjustment - Upholstered Back Jacket w/Plastic Base													
Pneumatic		SZTC 22-412MA		\$1817.04	\$1891.88	\$1971.70	\$2011.64	\$2041.58	\$2113.94	\$2178.78	\$2355.92	\$2478.16	\$2803.12
Back Stop		SZTC-22-411MA		1817.04	1891.88	1971.70	2011.64	2041.58	2113.94	2178.78	2355.92	2478.16	2803.12
PAL Back System - Mesh w/Plastic Base													
Pneumatic		SZTC-20-422MA		\$1722.24	\$1759.66	\$1799.57	\$1819.54	\$1834.51	\$1870.69	\$1903.11	\$1991.68	\$2052.80	\$2215.28
Back Stop		SZTC-20-421MA		1722.24	1759.66	1799.57	1819.54	1834.51	1870.69	1903.11	1991.68	2052.80	2215.28
PAL Back System - Knit w/Plastic Base													
Pneumatic		SZTC 20-422MA		\$1870.87	\$1908.29	\$1948.20	\$1968.17	\$1983.14	\$2019.32	\$2051.74	\$2140.31	\$2201.43	\$2363.91
Back Stop		SZTC-20-421MA		1870.87	1908.29	1948.20	1968.17	1983.14	2019.32	2051.74	2140.31	2201.43	2363.91
PAL Back System - Upholstered Back Jacket w/Plastic Base													
Pneumatic		SZTC-22-422MA		\$1845.73	\$1920.57	\$2000.39	\$2040.33	\$2070.27	\$2142.63	\$2207.47	\$2384.61	\$2506.85	\$2831.81
Back Stop		SZTC-22-421MA		1845.73	1920.57	2000.39	2040.33	2070.27	2142.63	2207.47	2384.61	2506.85	2831.81

The following options require modification of the product number.

- Fixed seat
- Stain repellent
- Leather Seat with Mesh Back
- Leather Seat with Leather Upholstered Back Jacket
- Faux Leather Seat with Mesh Back
- Faux Leather Seat with Faux Leather Upholstered Back Jacket

To specify, change the 11th digit from A to X; **Example:** SZTC-20-402MX1
 To specify, add P to end of the product number (add \$38.67 list); **Example:** SZTC-20-401MAP
 To specify, change the 5th digit to 1 and 6th digit to 0; **Example:** SZTC-10-402MA5
 To specify, change the 5th digit to 1 and 6th digit to 1; **Example:** SZTC-11-402MA5
 To specify, change the 5th digit to 3; **Example:** SZTC-30-402MA5
 To specify, change the 5th and 6th digits to 33; **Example:** SZTC-33-402MA5
NOTE: For available fabrics, refer to surfaces.haworth.com.

⚠️ OBSOLETE | September 2022 Task Stool with Height Adjustable Arms
Pneumatic configurations have been obsolete.

Upholstered Gel Insert Seat	Adjustments	Number	①	Fabric Grade								Leather Grade A	Leather Grade B
				A	B	C	D	E	F	G	H		
No Lumbar Adjustment - Mesh w/Plastic Base													
Pneumatic	SZTC-20-402EA			\$1687.32	\$1724.74	\$1764.65	\$1784.62	\$1799.59	\$1835.77	\$1868.19	\$1956.76	\$2017.88	\$2180.36
Back Stop	SZTC-20-401EA			1687.32	1724.74	1764.65	1784.62	1799.59	1835.77	1868.19	1956.76	2017.88	2180.36
No Lumbar Adjustment - Knit w/Plastic Base													
Pneumatic	SZTC-20-402EA			\$1835.95	\$1873.37	\$1913.28	\$1933.25	\$1948.22	\$1984.40	\$2016.82	\$2105.39	\$2166.51	\$2328.99
Back Stop	SZTC-20-401EA			1835.95	1873.37	1913.28	1933.25	1948.22	1984.40	2016.82	2105.39	2166.51	2328.99
No Lumbar Adjustment - Upholstered Back Jacket w/Plastic Base													
Pneumatic	SZTC-22-402EA			\$1810.81	\$1885.65	\$1965.47	\$2005.41	\$2035.35	\$2107.71	\$2172.55	\$2349.69	\$2471.93	\$2796.89
Back Stop	SZTC-22-401EA			1810.81	1885.65	1965.47	2005.41	2035.35	2107.71	2172.55	2349.69	2471.93	2796.89
Lumbar Adjustment - Mesh w/Plastic Base													
Pneumatic	SZTC-20-412EA			\$1797.10	\$1834.52	\$1874.43	\$1894.40	\$1909.37	\$1945.55	\$1977.97	\$2066.54	\$2127.66	\$2290.14
Back Stop	SZTC-20-411EA			1797.10	1834.52	1874.43	1894.40	1909.37	1945.55	1977.97	2066.54	2127.66	2290.14
Lumbar Adjustment - Knit w/Plastic Base													
Pneumatic	SZTC-20-412EA			\$1945.73	\$1983.15	\$2023.06	\$2043.03	\$2058.00	\$2094.18	\$2126.60	\$2215.17	\$2276.29	\$2438.77
Back Stop	SZTC-20-411EA			1945.73	1983.15	2023.06	2043.03	2058.00	2094.18	2126.60	2215.17	2276.29	2438.77
Lumbar Adjustment - Upholstered Back Jacket w/Plastic Base													
Pneumatic	SZTC-22-412EA			\$1920.59	\$1995.43	\$2075.25	\$2115.19	\$2145.13	\$2217.49	\$2282.33	\$2459.47	\$2581.71	\$2906.67
Back Stop	SZTC-22-411EA			1920.59	1995.43	2075.25	2115.19	2145.13	2217.49	2282.33	2459.47	2581.71	2906.67
PAL Back System - Mesh w/Plastic Base													
Pneumatic	SZTC-20-422EA			\$1825.79	\$1863.21	\$1903.12	\$1923.09	\$1938.06	\$1974.24	\$2006.66	\$2095.23	\$2156.35	\$2318.83
Back Stop	SZTC-20-421EA			1825.79	1863.21	1903.12	1923.09	1938.06	1974.24	2006.66	2095.23	2156.35	2318.83
PAL Back System - Knit w/Plastic Base													
Pneumatic	SZTC-20-422EA			\$1974.42	\$2011.84	\$2051.75	\$2071.72	\$2086.69	\$2122.87	\$2155.29	\$2243.86	\$2304.98	\$2467.46
Back Stop	SZTC-20-421EA			1974.42	2011.84	2051.75	2071.72	2086.69	2122.87	2155.29	2243.86	2304.98	2467.46
PAL Back System - Upholstered Back Jacket w/Plastic Base													
Pneumatic	SZTC-22-422EA			\$1949.28	\$2024.12	\$2103.94	\$2143.88	\$2173.82	\$2246.18	\$2311.02	\$2488.16	\$2610.40	\$2935.36
Back Stop	SZTC-22-421EA			1949.28	2024.12	2103.94	2143.88	2173.82	2246.18	2311.02	2488.16	2610.40	2935.36

The following options require modification of the product number.

- Fixed seat
- Stain repellent
- Leather Seat with Mesh Back
- Leather Seat with Leather Upholstered Back Jacket
- Faux Leather Seat with Mesh Back
- Faux Leather Seat with Faux Leather Upholstered Back Jacket

- To specify, change the 11th digit from A to X; **Example:** SZTC-20-402EX1
- To specify, add P to end of the product number (add \$38.67 list); **Example:** SZTC-20-422EA1P
- To specify, change the 5th digit to 1 and 6th digit to 0; **Example:** SZTC-10-402EA5
- To specify, change the 5th digit to 1 and 6th digit to 1; **Example:** SZTC-11-402EA5
- To specify, change the 5th digit to 3; **Example:** SZTC-30-402EA5
- To specify, change the 5th and 6th digits to 33; **Example:** SZTC-33-402EA5

NOTE: For available fabrics, refer to surfaces.haworth.com.

This page intentionally blank

Zody

Task Stool with Fixed Arms



SZTC-20-102MA1

Dimensions*

- *SH: 21.5-29" (546mm-737mm)
- H: 43-51"(1092mm-1295mm)
- D: 29"(737mm)
- W: 29"(737mm)
- *SW: 19.25"(489mm)
- *SD: 16-19"(406mm-483mm)
- *AH: 9"(229mm)

* All measurements taken with the BIFMA chair measuring device.

Features

- Back: Knit, mesh, or mesh back with upholstered back jacket.
- Seat: Standard upholstered with foam or optional foam with Technogel® Soft Lite gel insert.
- Seat Type: Standard adjustable [3"(76mm) range] or optional fixed.
- Base: Standard Plastic painted five-star base or optional painted aluminum or polished aluminum. –Plastic base available in Black. –Aluminum base available with painted Black, Metallic Silver, Metallic Champagne, or optional Polished Aluminum.
- Arms: Fixed with soft arm caps. See matrix for default colors.
- Mechanism: Balanced 3-point tilt; standard tilt tension.
- Height adjustment: Pneumatic.
- Optional Back Stop: Tilt stop in 6 positions.
- Optional Asymmetrical Lumbar Adjustment: 4"(102mm) height adjustment; support level can be adjusted independently for right or left hand side of users body. Optional PAL Back System: Passive pelvic support.
- Casters: Hard or soft casters in black only.
- COM yardage / COL square footage:
Mesh back model: 0.75/10
Mesh back/upholstered back jacket: 1.5/18

NOTE: When specifying fabric or leather back jacket; must also specify mesh surface color for outside back.

Upcharge for mixed grade surfaces, refer to the electronic design and specification tools.

To Order with Fabric or Leather Upholstered Back Jacket Specify:

1) Product number, including:

1 Base/Caster Option:

Aluminum Base

- 1 Aluminum Base, Hard Caster, add **\$35.64** to list
- 2 Aluminum Base, Soft Caster, add **\$80.64** to list

Plastic Base

- 5 Plastic Std. Base, Hard Caster
- 6 Plastic Std. Base, Soft Caster, add **\$45.00** to list

- 2) Fabric surface and color (seat).
- 3) Mesh surface color (back).
- 4) Fabric surface and color (back jacket).
- 5) Trim color for frame. (Add **\$61.00** list for Snow.)
- 6) Trim color for base/arms. (Add **\$208.32** list for polished aluminum.)

To Order with Knit or Mesh Back Specify:

1) Product number, including:

1 Base/Caster Option:

Aluminum Base

- 1 Aluminum Base, Hard Caster, add **\$35.64** to list
- 2 Aluminum Base, Soft Caster, add **\$80.64** to list

Plastic Base

- 5 Plastic Std. Base, Hard Caster
- 6 Plastic Std. Base, Soft Caster, add **\$45.00** to list

- 2) Fabric surface and color (seat).
- 3) Knit or Mesh surface and color (back).
- 4) Trim color for frame. (Add **\$61.00** list for Snow.)
- 5) Trim color for base/arms. (Add **\$208.32** list for polished aluminum.)

Trim Color ¹	Arm Cap Color*	
	Black	Smoke
Black (TR-F)	•	
Smoke (TR-E)		•
Snow (TR-UFM)		•

*Not specifiable.

¹Plastic base option will default all metal trim to Black (TR-F).

Zody

Task Stool with Fixed Arms

 **OBSOLETE** | September 2022
Pneumatic configurations have been obsolete.

Upholstered Foam Seat	Adjustments	Number	Fabric Grade								Leather Grade A	Leather Grade B
			A	B	C	D	E	F	G	H		
No Lumbar Adjustment - Mesh Back w/Plastic Base												
Pneumatic		SZTC-20-102MA	\$1498.95	\$1536.37	\$1576.28	\$1596.25	\$1611.22	\$1647.40	\$1679.82	\$1768.39	\$1829.51	\$1991.99
Back Stop		SZTC-20-101MA	1498.95	1536.37	1576.28	1596.25	1611.22	1647.40	1679.82	1768.39	1829.51	1991.99
No Lumbar Adjustment - Knit Back w/Plastic Base												
Pneumatic		SZTC-20-102MA	\$1647.58	\$1685.00	\$1724.91	\$1744.88	\$1759.85	\$1796.03	\$1828.45	\$1917.02	\$1978.14	\$2140.62
Back Stop		SZTC-20-101MA	1647.58	1685.00	1724.91	1744.88	1759.85	1796.03	1828.45	1917.02	1978.14	2140.62
No Lumbar Adjustment - Upholstered Back Jacket w/Plastic Base												
Pneumatic		SZTC-22-102MA	\$1622.44	\$1697.28	\$1777.10	\$1817.04	\$1846.98	\$1919.34	\$1984.18	\$2161.32	\$2283.56	\$2608.52
Back Stop		SZTC-22-101MA	1622.44	1697.28	1777.10	1817.04	1846.98	1919.34	1984.18	2161.32	2283.56	2608.52
Lumbar Adjustment - Mesh Back w/Plastic Base												
Pneumatic		SZTC-20-112MA	\$1608.73	\$1646.15	\$1686.06	\$1706.03	\$1721.00	\$1757.18	\$1789.60	\$1878.17	\$1939.29	\$2101.77
Back Stop		SZTC-20-111MA	1608.73	1646.15	1686.06	1706.03	1721.00	1757.18	1789.60	1878.17	1939.29	2101.77
Lumbar Adjustment - Knit Back w/Plastic Base												
Pneumatic		SZTC-20-112MA	\$1757.36	\$1794.78	\$1834.69	\$1854.66	\$1869.63	\$1905.81	\$1938.23	\$2026.80	\$2087.92	\$2250.40
Back Stop		SZTC-20-111MA	1757.36	1794.78	1834.69	1854.66	1869.63	1905.81	1938.23	2026.80	2087.92	2250.40
Lumbar Adjustment - Upholstered Back Jacket w/Plastic Base												
Pneumatic		SZTC-22-112MA	\$1732.22	\$1807.06	\$1886.88	\$1926.82	\$1956.76	\$2029.12	\$2093.96	\$2271.10	\$2393.34	\$2718.30
Back Stop		SZTC-22-111MA	1732.22	1807.06	1886.88	1926.82	1956.76	2029.12	2093.96	2271.10	2393.34	2718.30
PAL Back System - Mesh Back w/Plastic Base												
Pneumatic		SZTC-20-122MA	\$1637.42	\$1674.84	\$1714.75	\$1734.72	\$1749.69	\$1785.87	\$1818.29	\$1906.86	\$1967.98	\$2130.46
Back Stop		SZTC-20-121MA	1637.42	1674.84	1714.75	1734.72	1749.69	1785.87	1818.29	1906.86	1967.98	2130.46
PAL Back System - Knit Back w/Plastic Base												
Pneumatic		SZTC-20-122MA	\$1786.05	\$1823.47	\$1863.38	\$1883.35	\$1898.32	\$1934.50	\$1966.92	\$2055.49	\$2116.61	\$2279.09
Back Stop		SZTC-20-121MA	1786.05	1823.47	1863.38	1883.35	1898.32	1934.50	1966.92	2055.49	2116.61	2279.09
PAL Back System - Upholstered Back Jacket w/Plastic Base												
Pneumatic		SZTC-22-122MA	\$1760.91	\$1835.75	\$1915.57	\$1955.51	\$1985.45	\$2057.81	\$2122.65	\$2299.79	\$2422.03	\$2746.99
Back Stop		SZTC-22-121MA	1760.91	1835.75	1915.57	1955.51	1985.45	2057.81	2122.65	2299.79	2422.03	2746.99

The following options require modification of the product number.

- Fixed seat
- Stain repellent
- Leather Seat with Mesh Back
- Leather Seat with Leather Upholstered Back Jacket
- Faux Leather Seat with Mesh Back
- Faux Leather Seat with Faux Leather Upholstered Back Jacket

- To specify, change the 11th digit from A to X; **Example:** SZTC-20-102MX1
- To specify, add **P** to end of the product number (add **\$38.67** list); **Example:** SZTC-22-101MA1P
- To specify, change the 5th digit to **1** and 6th digit to **0**; **Example:** SZTC-10-102MA5
- To specify, change the 5th digit to **1** and 6th digit to **1**; **Example:** SZTC-11-102MA5
- To specify, change the 5th digit to **3**; **Example:** SZTC-30-102MA5
- To specify, change the 5th and 6th digits to **33**; **Example:** SZTC-33-102MA5

NOTE: For available fabrics, refer to surfaces.haworth.com.

! OBSOLETE | September 2022
Pneumatic configurations have been obsolete.

Zody
Task Stool with Fixed Arms

Upholstered Gel Insert Seat	Adjustments	Number	①	Fabric Grade								Leather Grade A	Leather Grade B
				A	B	C	D	E	F	G	H		
No Lumbar Adjustment - Mesh Back w/Plastic Base													
Pneumatic	SZTC-20-102EA			\$1602.50	\$1639.92	\$1679.83	\$1699.80	\$1714.77	\$1750.95	\$1783.37	\$1871.94	\$1933.06	\$2095.54
Back Stop	SZTC-20-101EA			1602.50	1639.92	1679.83	1699.80	1714.77	1750.95	1783.37	1871.94	1933.06	2095.54
No Lumbar Adjustment - Knit Back w/Plastic Base													
Pneumatic	SZTC-20-102EA			\$1751.13	\$1788.55	\$1828.46	\$1848.43	\$1863.40	\$1899.58	\$1932.00	\$2020.57	\$2081.69	\$2244.17
Back Stop	SZTC-20-101EA			1751.13	1788.55	1828.46	1848.43	1863.40	1899.58	1932.00	2020.57	2081.69	2244.17
No Lumbar Adjustment - Upholstered Back Jacket w/Plastic Base													
Pneumatic	SZTC-22-102EA			\$1725.99	\$1800.83	\$1880.65	\$1920.59	\$1950.53	\$2022.89	\$2087.73	\$2264.87	\$2387.11	\$2712.07
Back Stop	SZTC-22-101EA			1725.99	1800.83	1880.65	1920.59	1950.53	2022.89	2087.73	2264.87	2387.11	2712.07
Lumbar Adjustment - Mesh Back w/Plastic Base													
Pneumatic	SZTC-20-112EA			\$1712.28	\$1749.70	\$1789.61	\$1809.58	\$1824.55	\$1860.73	\$1893.15	\$1981.72	\$2042.84	\$2205.32
Back Stop	SZTC-20-111EA			1712.28	1749.70	1789.61	1809.58	1824.55	1860.73	1893.15	1981.72	2042.84	2205.32
Lumbar Adjustment - Knit Back w/Plastic Base													
Pneumatic	SZTC-20-112EA			\$1860.91	\$1898.33	\$1938.24	\$1958.21	\$1973.18	\$2009.36	\$2041.78	\$2130.35	\$2191.47	\$2353.95
Back Stop	SZTC-20-111EA			1860.91	1898.33	1938.24	1958.21	1973.18	2009.36	2041.78	2130.35	2191.47	2353.95
Lumbar Adjustment - Upholstered Back Jacket w/Plastic Base													
Pneumatic	SZTC-22-112EA			\$1835.77	\$1910.61	\$1990.43	\$2030.37	\$2060.31	\$2132.67	\$2197.51	\$2374.65	\$2496.89	\$2821.85
Back Stop	SZTC-22-111EA			1835.77	1910.61	1990.43	2030.37	2060.31	2132.67	2197.51	2374.65	2496.89	2821.85
PAL Back System - Mesh Back w/Plastic Base													
Pneumatic	SZTC-20-122EA			\$1740.97	\$1778.39	\$1818.30	\$1838.27	\$1853.24	\$1889.42	\$1921.84	\$2010.41	\$2071.53	\$2234.01
Back Stop	SZTC-20-121EA			1740.97	1778.39	1818.30	1838.27	1853.24	1889.42	1921.84	2010.41	2071.53	2234.01
PAL Back System - Knit Back w/Plastic Base													
Pneumatic	SZTC-20-122EA			\$1889.60	\$1927.02	\$1966.93	\$1986.90	\$2001.87	\$2038.05	\$2070.47	\$2159.04	\$2220.16	\$2382.64
Back Stop	SZTC-20-121EA			1889.60	1927.02	1966.93	1986.90	2001.87	2038.05	2070.47	2159.04	2220.16	2382.64
PAL Back System - Upholstered Back Jacket w/Plastic Base													
Pneumatic	SZTC-22-122EA			\$1864.46	\$1939.30	\$2019.12	\$2059.06	\$2089.00	\$2161.36	\$2226.20	\$2403.34	\$2525.58	\$2850.54
Back Stop	SZTC-22-121EA			1864.46	1939.30	2019.12	2059.06	2089.00	2161.36	2226.20	2403.34	2525.58	2850.54

The following options require modification of the product number.

- Fixed seat
- Stain repellent
- Leather Seat with Mesh Back
- Leather Seat with Leather Upholstered Back Jacket
- Faux Leather Seat with Mesh Back
- Faux Leather Seat with Faux Leather Upholstered Back Jacket

- To specify, change the 11th digit from A to X; **Example:** SZTC-20-102EX1
- To specify, add P to end of the product number (add \$38.67 list); **Example:** SZTC-20-102EA1P
- To specify, change the 5th digit to 1 and 6th digit to 0; **Example:** SZTC-10-102EA5
- To specify, change the 5th digit to 1 and 6th digit to 1; **Example:** SZTC-11-102EA5
- To specify, change the 5th digit to 3; **Example:** SZTC-30-102EA5
- To specify, change the 5th and 6th digits to 33; **Example:** SZTC-33-102EA5

NOTE: For available fabrics, refer to surfaces.haworth.com.

This page intentionally blank

Zody

Task Stool without Arms



SZTC-20-002MA1

Dimensions*

- *SH: 21.5-29"
(546mm-737mm)
- H: 43-51"(1092mm-1295mm)
- D: 29"(737mm)
- W: 29"(737mm)
- *SW: 19.25"(489mm)
- *SD: 16-19"(406mm-483mm)

* All measurements taken with the BIFMA chair measuring device.

Features

- Back: Knit, mesh, or mesh back with upholstered back jacket.
- Seat: Standard upholstered with foam or optional foam with Technogel® Soft Lite gel insert.
- Seat Type: Standard adjustable [3"(76mm) range] or optional fixed.
- Base: Standard Plastic painted five-star base or optional painted aluminum or polished aluminum.
 - Plastic base available in Black.
 - Aluminum base available with painted Black, Metallic Silver, Metallic Champagne, or optional Polished Aluminum.
- Mechanism: Balanced 3-point tilt; standard tilt tension.
- Height adjustment: Pneumatic.
- Optional Back Stop: Tilt stop in 6 positions.
- Optional Asymmetrical Lumbar Adjustment: 4"(102mm) height adjustment; support level can be adjusted independently for right or left hand side of users body. Optional PAL Back System: Passive pelvic support
- Casters: Hard or soft casters in black only.
- COM yardage / COL square footage:
 - Mesh back model: 0.75/10
 - Mesh back/upholstered back jacket: 1.5/18

NOTE: When specifying fabric or leather back jacket; must also specify mesh surface color for outside back.

NOTE: Plastic base option will default all metal trim to Black (TR-F).

Upcharge for mixed grade surfaces, refer to the electronic design and specification tools.

To Order with Fabric or Leather Upholstered Back Jacket Specify:

1) Product number, including:

1 Base/Caster Option:**Aluminum Base**

- 1** Aluminum Base, Hard Caster, add **\$35.64** to list
- 2** Aluminum Base, Soft Caster, add **\$80.64** to list

Plastic Base

- 5** Plastic Std. Base, Hard Caster
- 6** Plastic Std. Base, Soft Caster, add **\$45.00** to list

- 2) Fabric surface and color (seat).
- 3) Mesh surface color (back).
- 4) Fabric surface and color (back jacket).
- 5) Trim color for frame. (Add **\$61.00** list for Snow.)
- 6) Trim color for base. (Add **\$208.32** list for polished aluminum.)

To Order with Knit or Mesh Back Specify:

1) Product number, including:

1 Base/Caster Option:**Aluminum Base**

- 1** Aluminum Base, Hard Caster, add **\$35.64** to list
- 2** Aluminum Base, Soft Caster, add **\$80.64** to list

Plastic Base

- 5** Plastic Std. Base, Hard Caster
- 6** Plastic Std. Base, Soft Caster, add **\$45.00** to list

- 2) Fabric surface and color (seat).
- 3) Knit or Mesh surface and color (back).
- 4) Trim color for frame. (Add **\$61.00** list for Snow.)
- 5) Trim color for base. (Add **\$208.32** list for polished aluminum.)

Zody

Task Stool without Arms

 **OBSOLETE** | September 2022
Pneumatic configurations have been obsolete.

Upholstered Foam Seat	Adjustments	Number	Fabric Grade									Leather Grade A	Leather Grade B
				A	B	C	D	E	F	G	H		
No Lumbar Adjustment - Mesh Back w/Plastic Base													
Pneumatic		SZTC-20-002MA	\$1360.48	\$1397.90	\$1437.81	\$1457.78	\$1472.75	\$1508.93	\$1541.35	\$1629.92	\$1691.04	\$1853.52	
Back Stop		SZTC-20-001MA	1360.48	1397.90	1437.81	1457.78	1472.75	1508.93	1541.35	1629.92	1691.04	1853.52	
No Lumbar Adjustment - Knit Back w/Plastic Base													
Pneumatic		SZTC-20-002MA	\$1509.11	\$1546.53	\$1586.44	\$1606.41	\$1621.38	\$1657.56	\$1689.98	\$1778.55	\$1839.67	\$2002.15	
Back Stop		SZTC-20-001MA	1509.11	1546.53	1586.44	1606.41	1621.38	1657.56	1689.98	1778.55	1839.67	2002.15	
No Lumbar Adjustment - Upholstered Back Jacket w/Plastic Base													
Pneumatic		SZTC-22-002MA	\$1483.97	\$1558.81	\$1638.63	\$1678.57	\$1708.51	\$1780.87	\$1845.71	\$2022.85	\$2145.09	\$2470.05	
Back Stop		SZTC-22-001MA	1483.97	1558.81	1638.63	1678.57	1708.51	1780.87	1845.71	2022.85	2145.09	2470.05	
Lumbar Adjustment - Mesh Back w/Plastic Base													
Pneumatic		SZTC-20-012MA	\$1470.26	\$1507.68	\$1547.59	\$1567.56	\$1582.53	\$1618.71	\$1651.13	\$1739.70	\$1800.82	\$1963.30	
Back Stop		SZTC-20-011MA	1470.26	1507.68	1547.59	1567.56	1582.53	1618.71	1651.13	1739.70	1800.82	1963.30	
Lumbar Adjustment - Knit Back w/Plastic Base													
Pneumatic		SZTC-20-012MA	\$1618.89	\$1656.31	\$1696.22	\$1716.19	\$1731.16	\$1767.34	\$1799.76	\$1888.33	\$1949.45	\$2111.93	
Back Stop		SZTC-20-011MA	1618.89	1656.31	1696.22	1716.19	1731.16	1767.34	1799.76	1888.33	1949.45	2111.93	
Lumbar Adjustment - Upholstered Back Jacket w/Plastic Base													
Pneumatic		SZTC-22-012MA	\$1593.75	\$1668.59	\$1748.41	\$1788.35	\$1818.29	\$1890.65	\$1955.49	\$2132.63	\$2254.87	\$2579.83	
Back Stop		SZTC-22-011MA	1593.75	1668.59	1748.41	1788.35	1818.29	1890.65	1955.49	2132.63	2254.87	2579.83	
PAL Back System - Mesh Back w/Plastic Base													
Pneumatic		SZTC-20-022MA	\$1498.95	\$1536.37	\$1576.28	\$1596.25	\$1611.22	\$1647.40	\$1679.82	\$1768.39	\$1829.51	\$1991.99	
Back Stop		SZTC-20-021MA	1498.95	1536.37	1576.28	1596.25	1611.22	1647.40	1679.82	1768.39	1829.51	1991.99	
PAL Back System - Knit Back w/Plastic Base													
Pneumatic		SZTC-20-022MA	\$1647.58	\$1685.00	\$1724.91	\$1744.88	\$1759.85	\$1796.03	\$1828.45	\$1917.02	\$1978.14	\$2140.62	
Back Stop		SZTC-20-021MA	1647.58	1685.00	1724.91	1744.88	1759.85	1796.03	1828.45	1917.02	1978.14	2140.62	
PAL Back System - Upholstered Back Jacket w/Plastic Base													
Pneumatic		SZTC-22-022MA	\$1622.44	\$1697.28	\$1777.10	\$1817.04	\$1846.98	\$1919.34	\$1984.18	\$2161.32	\$2283.56	\$2608.52	
Back Stop		SZTC-22-021MA	1622.44	1697.28	1777.10	1817.04	1846.98	1919.34	1984.18	2161.32	2283.56	2608.52	

The following options require modification of the product number.

- Fixed seat
- Stain repellent
- Leather Seat with Mesh Back
- Leather Seat with Leather Upholstered Back Jacket
- Faux Leather Seat with Mesh Back
- Faux Leather Seat with Faux Leather Upholstered Back Jacket

- To specify, change the 11th digit from A to X; **Example:** SZTC-20-002MX1
- To specify, add **P** to end of the product number (add \$38.67 list); **Example:** SZTC-20-002MA1P
- To specify, change the 5th digit to **1** and 6th digit to **0**; **Example:** SZTC-10-002MA5
- To specify, change the 5th digit to **1** and 6th digit to **1**; **Example:** SZTC-11-002MA5
- To specify, change the 5th digit to **3**; **Example:** SZTC-30-002MA5
- To specify, change the 5th and 6th digits to **33**; **Example:** SZTC-33-002MA5

NOTE: For available fabrics, refer to surfaces.haworth.com.

⚠️ OBSOLETE | September 2022

Pneumatic configurations have been obsolete.

Upholstered Gel Insert Seat	Adjustments	Number	①	Fabric Grade								Leather Grade A	Leather Grade B
				A	B	C	D	E	F	G	H		
No Lumbar Adjustment - Mesh Back w/Plastic Base													
Pneumatic	SZTC-20-002EA			\$1464.03	\$1501.45	\$1541.36	\$1561.33	\$1576.30	\$1612.48	\$1644.90	\$1733.47	\$1794.59	\$1957.07
Back Stop	SZTC-20-001EA			1464.03	1501.45	1541.36	1561.33	1576.30	1612.48	1644.90	1733.47	1794.59	1957.07
No Lumbar Adjustment - Knit Back w/Plastic Base													
Pneumatic	SZTC-20-002EA			\$1612.66	\$1650.08	\$1689.99	\$1709.96	\$1724.93	\$1761.11	\$1793.53	\$1882.10	\$1943.22	\$2105.70
Back Stop	SZTC-20-001EA			1612.66	1650.08	1689.99	1709.96	1724.93	1761.11	1793.53	1882.10	1943.22	2105.70
No Lumbar Adjustment - Upholstered Back Jacket w/Plastic Base													
Pneumatic	SZTC-22-002EA			\$1587.52	\$1662.36	\$1742.18	\$1782.12	\$1812.06	\$1884.42	\$1949.26	\$2126.40	\$2248.64	\$2573.60
Back Stop	SZTC-22-001EA			1587.52	1662.36	1742.18	1782.12	1812.06	1884.42	1949.26	2126.40	2248.64	2573.60
Lumbar Adjustment - Mesh Back w/Plastic Base													
Pneumatic	SZTC-20-012EA			\$1573.81	\$1611.23	\$1651.14	\$1671.11	\$1686.08	\$1722.26	\$1754.68	\$1843.25	\$1904.37	\$2066.85
Back Stop	SZTC-20-011EA			1573.81	1611.23	1651.14	1671.11	1686.08	1722.26	1754.68	1843.25	1904.37	2066.85
Lumbar Adjustment - Knit Back w/Plastic Base													
Pneumatic	SZTC-20-012EA			\$1722.44	\$1759.86	\$1799.77	\$1819.74	\$1834.71	\$1870.89	\$1903.31	\$1991.88	\$2053.00	\$2215.48
Back Stop	SZTC-20-011EA			1722.44	1759.86	1799.77	1819.74	1834.71	1870.89	1903.31	1991.88	2053.00	2215.48
Lumbar Adjustment - Upholstered Back Jacket w/Plastic Base													
Pneumatic	SZTC-22-012EA			\$1697.30	\$1772.14	\$1851.96	\$1891.90	\$1921.84	\$1994.20	\$2059.04	\$2236.18	\$2358.42	\$2683.38
Back Stop	SZTC-22-011EA			1697.30	1772.14	1851.96	1891.90	1921.84	1994.20	2059.04	2236.18	2358.42	2683.38
PAL Back System - Mesh Back w/Plastic Base													
Pneumatic	SZTC-20-022EA			\$1602.50	\$1639.92	\$1679.83	\$1699.80	\$1714.77	\$1750.95	\$1783.37	\$1871.94	\$1933.06	\$2095.54
Back Stop	SZTC-20-021EA			1602.50	1639.92	1679.83	1699.80	1714.77	1750.95	1783.37	1871.94	1933.06	2095.54
PAL Back System - Knit Back w/Plastic Base													
Pneumatic	SZTC-20-022EA			\$1751.13	\$1788.55	\$1828.46	\$1848.43	\$1863.40	\$1899.58	\$1932.00	\$2020.57	\$2081.69	\$2244.17
Back Stop	SZTC-20-021EA			1751.13	1788.55	1828.46	1848.43	1863.40	1899.58	1932.00	2020.57	2081.69	2244.17
PAL Back System - Upholstered Back Jacket w/Plastic Base													
Pneumatic	SZTC-22-022EA			\$1725.99	\$1800.83	\$1880.65	\$1920.59	\$1950.53	\$2022.89	\$2087.73	\$2264.87	\$2387.11	\$2712.07
Back Stop	SZTC-22-021EA			1725.99	1800.83	1880.65	1920.59	1950.53	2022.89	2087.73	2264.87	2387.11	2712.07

The following options require modification of the product number.

- Fixed seat
- Stain repellent
- Leather Seat with Mesh Back
- Leather Seat with Leather Upholstered Back Jacket
- Faux Leather Seat with Mesh Back
- Faux Leather Seat with Faux Leather Upholstered Back Jacket

- To specify, change the 11th digit from A to X; **Example:** SZTC-20-002EX1
- To specify, add P to end of the product number (add \$38.67 list); **Example:** SZTC-20-002EA1P
- To specify, change the 5th digit to 1 and 6th digit to 0; **Example:** SZTC-10-002EA5
- To specify, change the 5th digit to 1 and 6th digit to 1; **Example:** SZTC-11-002EA5
- To specify, change the 5th digit to 3; **Example:** SZTC-30-002EA5
- To specify, change the 5th and 6th digits to 33; **Example:** SZTC-33-002EA5

NOTE: For available fabrics, refer to surfaces.haworth.com.

Zody

Sled Base



SZG-22-1

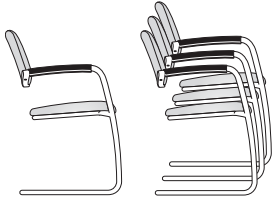

Dimensions*

- *SH: 18" (457mm)
- H: 32.5" (826mm)
- D: 22.1" (501mm)
- W: 21" (533mm)
- *SW: 16.8" (427mm)
- *SD: 17" (432mm)
- *AH: 26" (660mm)

* All measurements taken with the BIFMA chair measuring device.

Features

- Back: Upholstered or Wood (Beech)
Fully cantilevered
- Seat: Upholstered
- Base: Sled
- Glide options: Plastic (S) or Felt (J)
(Felt glides for use on hard floors. Glides are retrofittable. See e-Parts.)
- Felt glides are black color.
- Optional Trivalent chrome frame
- Stacking: 4-high
- COM Yardage / COL square footage
Back: 0.75/15.2
Seat: 0.75/15.2

To Order, Specify:

1) Product number, including:

1 Sled Base Glides:

- S** Plastic
- J** Felt

- 2) Seat surface and color
- 3) Back surface and color
- 4) Arm cap trim color
- 5) Base trim color
Trivalent chrome (KR-V)
add **\$208.32** list

Seat	Back	Number ①	Fabric Grade								Leather Grade A	Leather Grade B
			A	B	C	D	E	F	G	H		
Fabric	Fabric	SZG-22-1	\$853.25	\$923.13	\$1002.95	\$1042.85	\$1072.81	\$1142.65	\$1207.51	\$1387.15	N/A	N/A
Fabric	Wood	SZG-2W-1	958.03	992.97	1032.88	1052.83	1067.81	1102.73	1135.16	1224.98	N/A	N/A
Leather	Leather	SZG-11-1	N/A	N/A	N/A	N/A	N/A	N/A	N/A	N/A	\$1509.43	\$1832.19
Leather	Wood	SZG-1W-1	N/A	N/A	N/A	N/A	N/A	N/A	N/A	N/A	1286.12	1447.50

The following options require modification of the product number.

- Stain repellent
- Moisture barrier with Stain Repellent
- Faux Leather Seat and Back
- Faux Leather Seat with Wood Back

- To specify, add **P** to end of the product number (add **\$38.67** list)
- To specify, add **D** to end of the product number (add **\$52.39** list)
- To specify, change the 4th digit to **3** and 5th digit to **3**; **Example:** SZG-33-S
- To specify, change the 4th digit to **3** and 5th digit to **W**; **Example:** SZG-3W-J

NOTE: Upcharge for mixed grade surfaces, refer to the electronic design and specification tools.
For available fabrics, refer to surfaces.haworth.com.

Zody

4 Leg

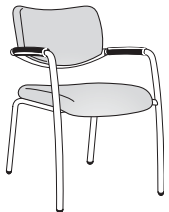

SZG-22-1



Dimensions*

- *SH: 18" (457mm)
- H: 32.5" (826mm)
- D: 22.13" (562mm)
- W: 21" (533mm)
- *SW: 16.4" (417mm)
- *SD: 17" (432mm)
- *AH: 26" (660mm)

* All measurements taken with the BIFMA chair measuring device.

Features

- Back: Upholstered or Wood (Beech) Fully cantilevered
- Seat: Upholstered
- Base: 4 Legs
- Optional Glide: Plastic (H) or Felt (K) (Felt glides for use on hard floors. Glides are retrofittable. See e-Parts.)
- Felt glides are black color.
- Optional Trivalent chrome frame
- Stacking: 6-high
- COM Yardage / COL square footage
Back: 0.75/15.2
Seat: 0.75/15.2

To Order, Specify:

- 1) Product number, including:
 - 1** **Leg Base Glides:**
 - H** Plastic
 - K** Felt
- 2) Seat surface and color
- 3) Back surface and color
- 4) Arm cap trim color
- 5) Base trim color
Trivalent chrome (KR-V) add **\$208.32** list

Seat	Back	Number ①	Fabric Grade								Leather Grade A	Leather Grade B
			A	B	C	D	E	F	G	H		
Fabric	Fabric	SZG-22-1	\$714.78	\$784.66	\$864.48	\$904.38	\$934.34	\$1004.18	\$1069.04	\$1248.68	N/A	N/A
Fabric	Wood	SZG-2W-1	819.56	854.50	894.41	914.36	929.34	964.26	996.69	1086.51	N/A	N/A
Leather	Leather	SZG-11-1	N/A	N/A	N/A	N/A	N/A	N/A	N/A	N/A	\$1370.96	\$1693.72
Leather	Wood	SZG-1W-1	N/A	N/A	N/A	N/A	N/A	N/A	N/A	N/A	1147.65	1309.03

The following options require modification of the product number.

- Stain repellent
- Moisture barrier with Stain Repellent
- Faux Leather Seat and Back
- Faux Leather Seat with Wood Back

- To specify, add **P** to end of the product number (add **\$38.67** list)
- To specify, add **D** to end of the product number (add **\$52.39** list)
- To specify, change the 4th digit to **3** and 5th digit to **3**; **Example:** SZG-**33**-S
- To specify, change the 4th digit to **3** and 5th digit to **W**; **Example:** SZG-**3W**-J

NOTE: Upcharge for mixed grade surfaces, refer to the electronic design and specification tools.

For available fabrics, refer to surfaces.haworth.com.

This page intentionally blank

Very Task

General Specifications

At-A-Glance

The Very Task chair offers state-of-the-art ergonomic support. Very Task offers Haworth's patented asymmetrical lumbar along with supporting mesh or knit back. A clean simple aesthetic, with unlimited choices, allowing you to personalize how you want to sit and work.

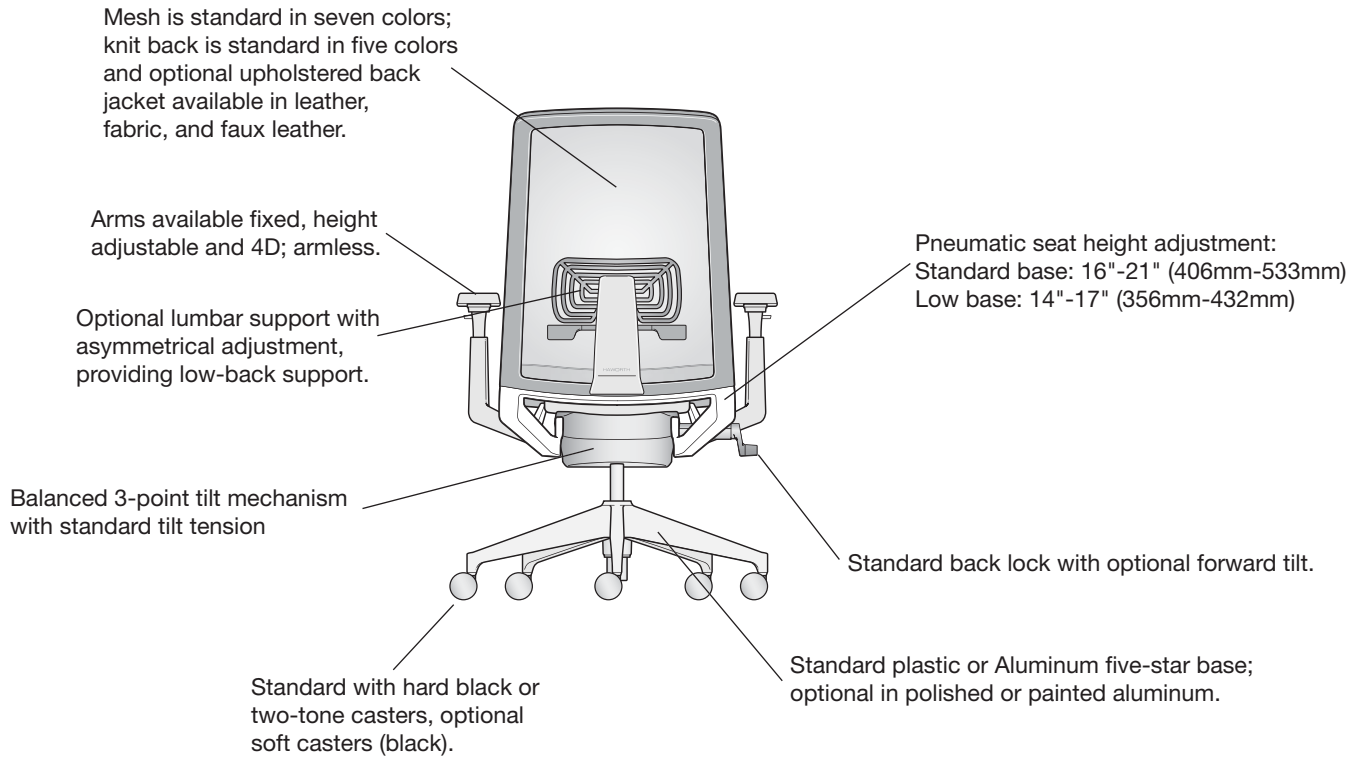

Very Task

General Specifications

Features and Options (Task Chair)

- Back: Mesh or knit with optional upholstered back jacket.
- Seat: Standard upholstered with foam.
- Seat Type: Standard depth adjustable range 16"-19" (406mm-483mm).
- Base: Standard plastic or optional painted five-star aluminum base or optional polished aluminum.
- Optional low base 14"-17"(356mm-432mm) (not available in high polished)
- Arms: 4D, Height Adjustable arms, fixed arms with soft arm caps. Armless model available.
- Mechanism: Balanced 3-point tilt; standard tilt tension.
- Height adjustment: Pneumatic or low-position pneumatic.
- Standard Back lock.
- Optional Forward Tilt: 5 degrees downward from initial position.
- Optional Adjustable Lumbar: 4" adjustment, flexible support.
- Optional Headrest: Height adjustable with articulating movement.
- Casters: Five-star base with casters: hard (black or two-tone (fog and gray), soft (black).
- Headrest sent not attached.

General Guidelines for Product Specification

	<u>S</u>	<u>C</u>	<u>T</u>	<u>- 2</u>	<u>0</u>	<u>- 4</u>	<u>1</u>	<u>1</u>	<u>1</u>	<u>3A-18</u>	<u>MS-FM</u>	<u>TR-F</u>	<u>TR-LE</u>	<u>TR-LE</u>
Product Fixed Arm	_____	_____	_____	_____	_____	_____	_____	_____	_____	_____	_____	_____	_____	_____
(S) Seating	_____	_____	_____	_____	_____	_____	_____	_____	_____	_____	_____	_____	_____	_____
Product Line	_____	_____	_____	_____	_____	_____	_____	_____	_____	_____	_____	_____	_____	_____
(C) Very	_____	_____	_____	_____	_____	_____	_____	_____	_____	_____	_____	_____	_____	_____
Model	_____	_____	_____	_____	_____	_____	_____	_____	_____	_____	_____	_____	_____	_____
(E) Headrest	_____	_____	_____	_____	_____	_____	_____	_____	_____	_____	_____	_____	_____	_____
(T) Task	_____	_____	_____	_____	_____	_____	_____	_____	_____	_____	_____	_____	_____	_____
Seat Upholstery	_____	_____	_____	_____	_____	_____	_____	_____	_____	_____	_____	_____	_____	_____
(1) Leather	_____	_____	_____	_____	_____	_____	_____	_____	_____	_____	_____	_____	_____	_____
(2) Fabric	_____	_____	_____	_____	_____	_____	_____	_____	_____	_____	_____	_____	_____	_____
(3) Faux Leather	_____	_____	_____	_____	_____	_____	_____	_____	_____	_____	_____	_____	_____	_____
Back	_____	_____	_____	_____	_____	_____	_____	_____	_____	_____	_____	_____	_____	_____
(0) Mesh or Knit - No Jacket	_____	_____	_____	_____	_____	_____	_____	_____	_____	_____	_____	_____	_____	_____
(1) Mesh with Leather Back Jacket	_____	_____	_____	_____	_____	_____	_____	_____	_____	_____	_____	_____	_____	_____
(2) Mesh with Fabric Back Jacket	_____	_____	_____	_____	_____	_____	_____	_____	_____	_____	_____	_____	_____	_____
(3) Mesh with Faux Leather Back Jacket	_____	_____	_____	_____	_____	_____	_____	_____	_____	_____	_____	_____	_____	_____
Arms	_____	_____	_____	_____	_____	_____	_____	_____	_____	_____	_____	_____	_____	_____
(0) No Arms	_____	_____	_____	_____	_____	_____	_____	_____	_____	_____	_____	_____	_____	_____
(1) Fixed Arms	_____	_____	_____	_____	_____	_____	_____	_____	_____	_____	_____	_____	_____	_____
(4) Height Adjustable	_____	_____	_____	_____	_____	_____	_____	_____	_____	_____	_____	_____	_____	_____
(7) 4D Arms	_____	_____	_____	_____	_____	_____	_____	_____	_____	_____	_____	_____	_____	_____
Lumbar	_____	_____	_____	_____	_____	_____	_____	_____	_____	_____	_____	_____	_____	_____
(0) No Lumbar	_____	_____	_____	_____	_____	_____	_____	_____	_____	_____	_____	_____	_____	_____
(1) Lumbar	_____	_____	_____	_____	_____	_____	_____	_____	_____	_____	_____	_____	_____	_____
Back Lock	_____	_____	_____	_____	_____	_____	_____	_____	_____	_____	_____	_____	_____	_____
(1) Back Lock	_____	_____	_____	_____	_____	_____	_____	_____	_____	_____	_____	_____	_____	_____
(4) Forward Tilt/Back Lock	_____	_____	_____	_____	_____	_____	_____	_____	_____	_____	_____	_____	_____	_____
Base/Caster	_____	_____	_____	_____	_____	_____	_____	_____	_____	_____	_____	_____	_____	_____
(1) Aluminum Standard Base, Hard Caster	_____	_____	_____	_____	_____	_____	_____	_____	_____	_____	_____	_____	_____	_____
(2) Aluminum Standard Base, Soft Caster	_____	_____	_____	_____	_____	_____	_____	_____	_____	_____	_____	_____	_____	_____
(3) Aluminum Low Base, Hard Caster	_____	_____	_____	_____	_____	_____	_____	_____	_____	_____	_____	_____	_____	_____
(4) Aluminum Low Base, Soft Caster	_____	_____	_____	_____	_____	_____	_____	_____	_____	_____	_____	_____	_____	_____
(5) Plastic Standard Base, Hard Caster	_____	_____	_____	_____	_____	_____	_____	_____	_____	_____	_____	_____	_____	_____
(6) Plastic Standard Base, Soft Caster	_____	_____	_____	_____	_____	_____	_____	_____	_____	_____	_____	_____	_____	_____
(P) Plastic Standard Base, Two-Tone Caster	_____	_____	_____	_____	_____	_____	_____	_____	_____	_____	_____	_____	_____	_____
(T) Aluminum Standard Base, Two-Tone Caster	_____	_____	_____	_____	_____	_____	_____	_____	_____	_____	_____	_____	_____	_____
Seat Upholstery	_____	_____	_____	_____	_____	_____	_____	_____	_____	_____	_____	_____	_____	_____
Tellure	_____	_____	_____	_____	_____	_____	_____	_____	_____	_____	_____	_____	_____	_____
Back Upholstery	_____	_____	_____	_____	_____	_____	_____	_____	_____	_____	_____	_____	_____	_____
Mesh Snow	_____	_____	_____	_____	_____	_____	_____	_____	_____	_____	_____	_____	_____	_____
Trim Color (Plastic Components)	_____	_____	_____	_____	_____	_____	_____	_____	_____	_____	_____	_____	_____	_____
Black	_____	_____	_____	_____	_____	_____	_____	_____	_____	_____	_____	_____	_____	_____
Frame Trim Color (Aluminum)	_____	_____	_____	_____	_____	_____	_____	_____	_____	_____	_____	_____	_____	_____
Metallic Silver	_____	_____	_____	_____	_____	_____	_____	_____	_____	_____	_____	_____	_____	_____
Base Trim Color (Plastic or Aluminum)	_____	_____	_____	_____	_____	_____	_____	_____	_____	_____	_____	_____	_____	_____
Metallic Silver	_____	_____	_____	_____	_____	_____	_____	_____	_____	_____	_____	_____	_____	_____

Very Task

General Specifications

Environmental Factors	<ul style="list-style-type: none"> • Refer to Product Environmental Data sheet (PED) for recycled content and certifications. • Very is produced in an ISO 14001 certified manufacturing facility. • Very Task is part of the Haworth Take Back Program. • Haworth will take back Very chairs after their useful life and recycle the components. Please contact Haworth's Material Recovery Center at (616)393-1215.
COM & COL General Information	<p>To order a COM fabric (Customer's Own Material), contact the Haworth Inquiry Center (1.800.426.8562), your local Haworth dealer, or go to haworth.com/surfaces to find out if the COM you have selected has already been tested and approved. The surface collection site also has information on the Haworth alliance program with Carnegie, Luna Textiles, and Maharam as well as our industry-leading Pre-Approved COM program.</p> <p>COM fabrics are placed into Grades based on the cost per linear yard. If a fabric's cost exceeds the range of our highest Grade it will be noted as Non-Graded. The product will be priced at Grade A; the COM fabric costs will appear as a separate line item. The fabric charge will be Haworth's purchase cost plus a 4% administrative fee (based on the cost of the fabric). Yardage calculations will include any applicable fabric repeat.</p> <p>COM Leather products will be priced at a leather Grade A; COL costs will appear as a separate line item. The leather costs will be Haworth's purchase cost plus a 4% administrative fee (based on the cost of the leather).</p>
Finishes and Fabrics	A complete listing of finishes and fabrics for Very seating is available in the back of the price list.
Shipping Weights (Including packaging)	<ul style="list-style-type: none"> • Chairs with arms: 55.2 pounds/1 chair per carton/17.37 cubic feet • Chairs without arms: 51.2 pounds/1 chair per carton/17.37 cubic feet
Seat	Stitched double seams. Vertically in the center and on the edges of the leather seat cushion.
Back	Vertical stitched double seams on the upholstered back jacket with leather and faux leather or Customers Own Leather or COM faux leather.

Very Task

General Specifications

STANDARD MOBILITY AND ADJUSTABILITY

Balanced 3-point tilt

**Features:**

- Balanced 3-point tilt mechanism.
- Back reclines 20° from the upright position.
- Seat pan moves downward 3° from the initial position.
- 2:1 recline ratio.

Benefits:

- Comfortable relaxed posture.
- Recline allows for the opening of the users' chest cavity providing good airflow to promote alertness.
- Users' feet remain flat on the floor.

Tilt Tension Control

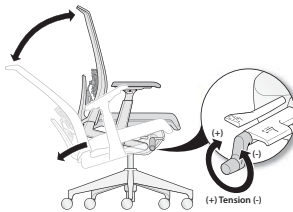
**Feature:**

- Easy-to-reach and easy-to-activate side-mounted unlimited tilt tension control regulates the amount of resistance felt when leaning back in the chair and the effort required to recline the chair backwards.

Benefit:

- Personalized support to accommodate users of different body types and different work styles.

Seat Height Adjustment

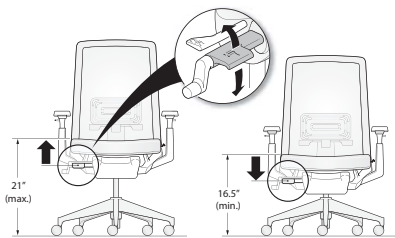
**Features:**

- Pneumatic seat height adjustment.
- Seat height adjusts 5"(127mm) from 16" to 21"(406mm to 533mm) in standard models. Low-position adjusts 14" to 17"(356 to 432mm).

Benefits:

- Ensures the comfort of the lower limbs by avoiding pressure on the underside of the thigh caused by a seat pan that is too high, or decreased thigh-to-torso angle if the seat pan is too low.
- Seat height adjustment also is important in setting the proper hand position and allowing for a proper sitting eye height.

Seat Depth Adjustment

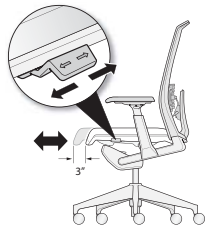
**Features:**

- 3"(76mm) of seat depth range.

Benefit:

- Supports the thighs, allows users to rest against the seat back for back support, and avoids pressure on the back of the knees of small to tall users.

Very Task

General Specifications

OPTIONAL MOBILITY AND ADJUSTABILITY

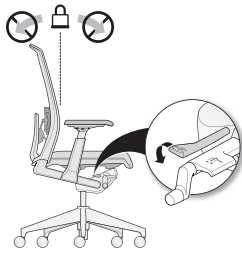
Back Lock**Feature:**

- Single position Back Lock.

Benefit:

- Allows users to lock the back of the chair in the upright position for tasking application.

Forward Tilt**Features:**

- Optional forward tilt.
- 5°

Benefit:

- Allows users the ability to elect an upright forward position.

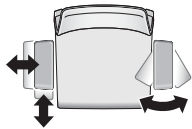
4D Arm**Features:**

- Optional 4D arm.
- Arm adjusts in 4 ways:
 - Height adjustment: 4"(102mm)
 - Side-to-side arm cap adjustment range: 3"(76mm) [1.5"(38.1mm) each arm cap]
 - Front-to-back adjustment range: 3.5"(89mm)
 - Pivoting: In 20°; out 20°

Benefits:

- Arms support the muscular system of users' neck and shoulders and proper arm support provides back relief. Arms can be an aid in standing or sitting down.
- Height adjustment accommodates for users with varying elbow rest heights so that users avoid lifting their shoulders or leaning sideways to get arm support.
- Front-to-back adjustment adjusts the armrest length, which is important because it allows users to get close to the worksurface while maintaining the effective use of the backrest.
- Side-to-side adjustment ensures a comfortable resting position for the arms with proper support of the forearm while allowing for easy entry/exit of the chair.
- Pivoting provides proper support of the forearm when performing tasks involving keying and mousing.

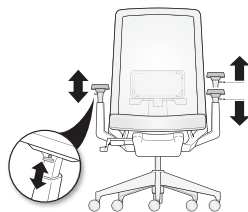
Adjustable Height Arm**Feature:**

- Optional height adjustable arms adjust 4"(102mm) vertically.

Benefit:

- Height adjustment accommodates users with varying elbow rest heights so that users avoid lifting their shoulders or leaning sideways to get arm support.

Very Task

General Specifications

OPTIONAL MOBILITY AND ADJUSTABILITY

Lumbar Support

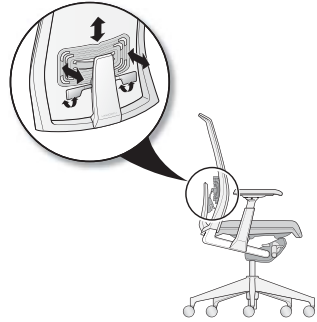

Features:

- Asymmetrical Left/right Lumbar Adjustment adjusts 4"(102mm) in height, flexible lumbar support with depth adjustment.

Benefits:

- Lumbar adjustment maintains the natural curvature of the spine at the lower back and allows users to choose the support that feels right for them.

Headrest



Features:

- Height adjustable 4.2"(107mm), articulating movement of headrest pad and mount to fit a wide range of users.
- Headrest is TPU material. Available in two finishes: black or fog; coordinates with the chair armrest color specified.
- See price pages for specification (available on all models).
- To add a headrest to an existing model in the field order service part: Back and Headrest placement, see e-Parts.
- Headrest sent not attached.

This page intentionally blank

Very Task

Task Chair with 4D Arms



SCT-20-7011

Dimensions

- *SH: 16-21"(406mm-533mm)
- H: 39-44"(991mm-1118mm)
- D: 26"(660mm)
- W: 27"(686mm)
- *SW: 19"(483mm)
- SD: 16"-19"
(406mm-483mm)
- AH: 6.5"-10.5"
(165mm-267mm)

Low Base:
14-17"(356mm-432mm)

* Measurements taken with the BIFMA chair measuring device.

Features

- Back: Knit, mesh or mesh back with upholstered back jacket.
- Seat: Standard upholstered foam (3 lbs. polyurethane foam construction).
- Base: Plastic base or optional painted five-star aluminum or polished aluminum base.
- Arms: 4D with soft arm caps. Arm adjusts up and down, side to side, front to back and pivot in and out.
- Mechanism: Balanced 3-point tilt; standard tilt tension.
- Back Lock: Single position upright back lock.
- Optional Forward Tilt: 5 degrees downward from initial position.
- Optional Asymmetrical Lumbar Adjustment: 4"(102mm) height adjustment; support level can be adjusted independently for right or left hand side of users body.
- Casters: Standard with hard black or two-tone casters; optional soft casters.
- COM yardage / COL square footage:
Mesh back model: 0.83/20
Mesh back/upholstered back jacket: 1.5/40

NOTE: When specifying a back jacket; must also specify mesh surface color for outside of back. Back jacket is not field retrofittable. To add a back jacket in the field, see e-Parts for replacement back with an attached jacket.

To Order, Specify:

1) Product number, including:

1 Base/Caster Option:**Aluminum Base**

- 1** Aluminum Std. Base, Hard Caster
- 2** Aluminum Std. Base, Soft Caster, add **\$45.00** to list
- T** Aluminum Std. Base, Two-Tone Casters
- 3** Aluminum Low Base, Hard Caster
- 4** Aluminum Low Base, Soft Caster, add **\$45.00** to list

Plastic Base

- 5** Plastic Std. Base, Hard Caster
- 6** Plastic Std. Base, Soft Caster, add **\$45.00** to list
- P** Plastic Std. Base, Two-Tone Casters

- 2) Fabric surface and color (seat).
- 3) Knit or mesh surface and color (back).
- 4) Back Jacket (if applicable) Fabric surface and color.
- 5) Trim color (plastic components) (arm caps, control cover, adjustment levers, 4D or height adjustable arm uprights).

Note: If TR-UFM is specified, arm caps and adjustment levers default to TR-7 Fog. (Add **\$104.27** list for TR-UFM Snow.)

- 6) Frame trim color (aluminum components - underside of chair).
- 7) Base trim color (plastic or aluminum) dependent upon base style selected; TR-UFM Snow (plastic) and TR-FS Snowfall (aluminum) not available.

Note: If PM-P Polished Aluminum is selected for aluminum frame components (#6) or aluminum base (#7), or both, a total upcharge of **\$213.60** list will apply.

Very Task

Task Chair with 4D Arms

Upholstered Seat Adjustments	Number ①	Fabric Grade								Leather Grade A	Leather Grade B
		A	B	C	D	E	F	G	H		
Plastic Base - Mesh Back											
Back Lock	SCT-20-701	\$1050.06	\$1088.64	\$1129.99	\$1149.28	\$1165.82	\$1201.65	\$1234.72	\$1322.92	\$1401.46	\$1573.45
Forward Tilt/Back Lock	SCT-20-704	1125.86	1164.44	1205.79	1225.08	1241.62	1277.45	1310.52	1398.72	1477.26	1649.25
Plastic Base - Knit Back											
Back Lock	SCT-20-701	\$1169.10	\$1207.68	\$1249.03	\$1268.32	\$1284.86	\$1320.69	\$1353.76	\$1441.96	\$1520.50	\$1692.49
Forward Tilt/Back Lock	SCT-20-704	1244.90	1283.48	1324.83	1344.12	1360.66	1396.49	1429.56	1517.76	1596.30	1768.29
Plastic Base - Upholstered Back Jacket											
Back Lock	SCT-22-701	\$1194.75	\$1271.91	\$1354.61	\$1393.19	\$1426.27	\$1497.93	\$1564.07	\$1740.47	\$1897.55	\$2241.53
Forward Tilt/Back Lock	SCT-22-704	1270.55	1347.71	1430.41	1468.99	1502.07	1573.73	1639.87	1816.27	1973.35	2317.33
Plastic Base with Lumbar Adjustment - Mesh Back											
Back Lock	SCT-20-711	\$1146.53	\$1185.11	\$1226.46	\$1245.75	\$1262.29	\$1298.12	\$1331.19	\$1419.39	\$1497.93	\$1669.92
Forward Tilt/Back Lock	SCT-20-714	1222.33	1260.91	1302.26	1321.55	1338.09	1373.92	1406.99	1495.19	1573.73	1745.72
Plastic Base with Lumbar Adjustment - Knit Back											
Back Lock	SCT-20-711	\$1265.57	\$1304.15	\$1345.50	\$1364.79	\$1381.33	\$1417.16	\$1450.23	\$1538.43	\$1616.97	\$1788.96
Forward Tilt/Back Lock	SCT-20-714	1341.37	1379.95	1421.30	1440.59	1457.13	1492.96	1526.03	1614.23	1692.77	1864.76
Plastic Base with Lumbar Adjustment - Upholstered Back Jacket											
Back Lock	SCT-22-711	\$1291.22	\$1368.38	\$1451.08	\$1489.66	\$1522.74	\$1594.40	\$1660.54	\$1836.94	\$1994.02	\$2338.00
Forward Tilt/Back Lock	SCT-22-714	1367.02	1444.18	1526.88	1565.46	1598.54	1670.20	1736.34	1912.74	2069.82	2413.80
Aluminum Base - Mesh Back											
Back Lock	SCT-20-701	\$1118.97	\$1157.55	\$1198.90	\$1218.19	\$1234.73	\$1270.56	\$1303.63	\$1391.83	\$1470.37	\$1642.36
Forward Tilt/Back Lock	SCT-20-704	1194.77	1233.35	1274.70	1293.99	1310.53	1346.36	1379.43	1467.63	1546.17	1718.16
Aluminum Base - Knit Back											
Back Lock	SCT-20-701	\$1238.01	\$1276.59	\$1317.94	\$1337.23	\$1353.77	\$1389.60	\$1422.67	\$1510.87	\$1589.41	\$1761.40
Forward Tilt/Back Lock	SCT-20-704	1313.81	1352.39	1393.74	1413.03	1429.57	1465.40	1498.47	1586.67	1665.21	1837.20
Aluminum Base - Upholstered Back Jacket											
Back Lock	SCT-22-701	\$1263.66	\$1340.82	\$1423.52	\$1462.10	\$1495.18	\$1566.84	\$1632.98	\$1809.38	\$1966.46	\$2310.44
Forward Tilt/Back Lock	SCT-22-704	1339.46	1416.62	1499.32	1537.90	1570.98	1642.64	1708.78	1885.18	2042.26	2386.24
Aluminum Base with Lumbar Adjustment - Mesh Back											
Back Lock	SCT-20-711	\$1215.44	\$1254.02	\$1295.37	\$1314.66	\$1331.20	\$1367.03	\$1400.10	\$1488.30	\$1566.84	\$1738.83
Forward Tilt/Back Lock	SCT-20-714	1291.24	1329.82	1371.17	1390.46	1407.00	1442.83	1475.90	1564.10	1642.64	1814.63
Aluminum Base with Lumbar Adjustment - Knit Back											
Back Lock	SCT-20-711	\$1334.48	\$1373.06	\$1414.41	\$1433.70	\$1450.24	\$1486.07	\$1519.14	\$1607.34	\$1685.88	\$1857.87
Forward Tilt/Back Lock	SCT-20-714	1410.28	1448.86	1490.21	1509.50	1526.04	1561.87	1594.94	1683.14	1761.68	1933.67
Aluminum Base with Lumbar Adjustment - Upholstered Back Jacket											
Back Lock	SCT-22-711	\$1360.13	\$1437.29	\$1519.99	\$1558.57	\$1591.65	\$1663.31	\$1729.45	\$1905.85	\$2062.93	\$2406.91
Forward Tilt/Back Lock	SCT-22-714	1435.93	1513.09	1595.79	1634.37	1667.45	1739.11	1805.25	1981.65	2138.73	2482.71

The following options require modification of the product number.

Headrest

Leather Seat with Knit or Mesh Back

Leather Seat with Leather Upholstered Back Jacket

Faux Leather Seat with Knit or Mesh Back

Stain repellent

To specify, change the 3rd digit from a T to an E. Example: SCE-22-7112 with headrest (add \$96.47 list)

To specify, change the 4th digit to 1; **Example:** SCT-10-7011

To specify, change the 4th digit to 1 and 5th digit to 1; **Example:** SCT-11-7011

To specify, change the 4th digit to 3; **Example:** SCT-30-7011

To specify, add P to end of the product number; **Example:** SCT-20-7011P (add \$42.72 list)

NOTE: Stain repellent is available on SCT-20 and SCT-22 models only.

Very Task

Task Chair with Height Adjustable Arms

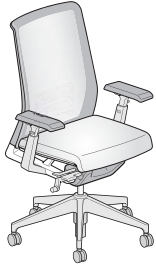

SCT-20-4011

Dimensions

*SH: 16-21"(406mm-533mm)
 H: 39-44"(991mm-1118mm)
 D: 26"(660mm)
 W: 27"(686mm)
 *SW: 19"(483mm)
 SD: 16"-19"(406mm-483mm)
 AH: 6.5"-10.5"
 (165mm-267mm)

Low Base:
 14-17"(356mm-432mm)

* Measurements taken with the BIFMA chair measuring device.

Features

- Back: Knit, mesh only or mesh back with upholstered back jacket.
- Seat: Standard upholstered foam (3 lbs. polyurethane foam construction).
- Base: Plastic base or optional painted five-star aluminum or polished aluminum base.
- Arms: Height-adjustable arms with plastic uprights (black or fog) with soft arm caps.
- Mechanism: Balanced 3-point tilt; standard tilt tension.
- Back Lock: Single position upright back lock.
- Optional Forward Tilt: 5 degrees downward from initial position.
- Optional Asymmetrical Lumbar Adjustment: 4"(102mm) height adjustment; support level can be adjusted independently for right or left hand side of users body.
- Casters: Standard with hard black or two-tone casters; optional soft casters.
- COM yardage / COL square footage:
 Mesh back model: 0.83/20
 Mesh back/upholstered back jacket: 1.5/40

NOTE: When specifying a back jacket; must also specify mesh surface color for outside of back. Back jacket is not field retrofittable. To add a back jacket in the field, see e-Parts for replacement back with an attached jacket.

To Order, Specify:

1) Product number, including:

1 Base/Caster Option:**Aluminum Base**

- 1** Aluminum Std. Base, Hard Caster
- 2** Aluminum Std. Base, Soft Caster, add **\$45.00** to list
- T** Aluminum Std. Base, Two-Tone Casters
- 3** Aluminum Low Base, Hard Caster
- 4** Aluminum Low Base, Soft Caster, add **\$45.00** to list

Plastic Base

- 5** Plastic Std. Base, Hard Caster
- 6** Plastic Std. Base, Soft Caster, add **\$45.00** to list
- P** Plastic Std. Base, Two-Tone Casters

- 2) Fabric surface and color (seat).
- 3) Knit or mesh surface and color (back).
- 4) Back Jacket (if applicable) Fabric surface and color.
- 5) Trim color (plastic components) (arm caps, control cover, adjustment levers, 4D or height adjustable arm uprights).

Note: If TR-UFM is specified, arm caps and adjustment levers default to TR-7 Fog. (Add **\$104.27** list for TR-UFM Snow.)

- 6) Frame trim color (aluminum components - underside of chair).
- 7) Base trim color (plastic or aluminum) dependent upon base style selected; TR-UFM Snow (plastic) and TR-FS Snowfall (aluminum) not available.

Note: If PM-P Polished Aluminum is selected for aluminum frame components (#6) or aluminum base (#7), or both, a total upcharge of **\$213.60** list will apply.

Very Task

Task Chair with Height Adjustable Arms

Upholstered Foam Seat Adjustments	Number ①	Fabric Grade								Leather Grade A	Leather Grade B
		A	B	C	D	E	F	G	H		
Plastic Base - Mesh Back											
Back Lock	SCT-20-401	\$ 981.15	\$1019.73	\$1061.08	\$1080.37	\$1096.91	\$1132.74	\$1165.81	\$1254.01	\$1332.55	\$1504.54
Forward Tilt/Back Lock	SCT-20-404	1056.95	1095.53	1136.88	1156.17	1172.71	1208.54	1241.61	1329.81	1408.35	1580.34
Plastic Base - Knit Back											
Back Lock	SCT-20-401	\$1100.19	\$1138.77	\$1180.12	\$1199.41	\$1215.95	\$1251.78	\$1284.85	\$1373.05	\$1451.59	\$1623.58
Forward Tilt/Back Lock	SCT-20-404	1175.99	1214.57	1255.92	1275.21	1291.75	1327.58	1360.65	1448.85	1527.39	1699.38
Plastic Base - Upholstered Back Jacket											
Back Lock	SCT-22-401	\$1125.84	\$1203.00	\$1285.70	\$1324.28	\$1357.36	\$1429.02	\$1495.16	\$1671.56	\$1828.64	\$2172.62
Forward Tilt/Back Lock	SCT-22-404	1201.64	1278.80	1361.50	1400.08	1433.16	1504.82	1570.96	1747.36	1904.44	2248.42
Plastic Base with Lumbar Adjustment - Mesh Back											
Back Lock	SCT-20-411	\$1077.62	\$1116.20	\$1157.55	\$1176.84	\$1193.38	\$1229.21	\$1262.28	\$1350.48	\$1429.02	\$1601.01
Forward Tilt/Back Lock	SCT-20-414	1153.42	1192.00	1233.35	1252.64	1269.18	1305.01	1338.08	1426.28	1504.82	1676.81
Plastic Base with Lumbar Adjustment - Knit Back											
Back Lock	SCT-20-411	\$1196.66	\$1235.24	\$1276.59	\$1295.88	\$1312.42	\$1348.25	\$1381.32	\$1469.52	\$1548.06	\$1720.05
Forward Tilt/Back Lock	SCT-20-414	1272.46	1311.04	1352.39	1371.68	1388.22	1424.05	1457.12	1545.32	1623.86	1795.85
Plastic Base with Lumbar Adjustment - Upholstered Back Jacket											
Back Lock	SCT-22-411	\$1222.31	\$1299.47	\$1382.17	\$1420.75	\$1453.83	\$1525.49	\$1591.63	\$1768.03	\$1925.11	\$2269.09
Forward Tilt/Back Lock	SCT-22-414	1298.11	1375.27	1457.97	1496.55	1529.63	1601.29	1667.43	1843.83	2000.91	2344.89
Aluminum Base - Mesh Back											
Back Lock	SCT-20-401	\$1050.06	\$1088.64	\$1129.99	\$1149.28	\$1165.82	\$1201.65	\$1234.72	\$1322.92	\$1401.46	\$1573.45
Forward Tilt/Back Lock	SCT-20-404	1125.86	1164.44	1205.79	1225.08	1241.62	1277.45	1310.52	1398.72	1477.26	1649.25
Aluminum Base - Knit Back											
Back Lock	SCT-20-401	\$1169.10	\$1207.68	\$1249.03	\$1268.32	\$1284.86	\$1320.69	\$1353.76	\$1441.96	\$1520.50	\$1692.49
Forward Tilt/Back Lock	SCT-20-404	1244.90	1283.48	1324.83	1344.12	1360.66	1396.49	1429.56	1517.76	1596.30	1768.29
Aluminum Base - Upholstered Back Jacket											
Back Lock	SCT-22-401	\$1194.75	\$1271.91	\$1354.61	\$1393.19	\$1426.27	\$1497.93	\$1564.07	\$1740.47	\$1897.55	\$2241.53
Forward Tilt/Back Lock	SCT-22-404	1270.55	1347.71	1430.41	1468.99	1502.07	1573.73	1639.87	1816.27	1973.35	2317.33
Aluminum Base with Lumbar Support - Mesh Back											
Back Lock	SCT-20-411	\$1146.53	\$1185.11	\$1226.46	\$1245.75	\$1262.29	\$1298.12	\$1331.19	\$1419.39	\$1497.93	\$1669.92
Forward Tilt/Back Lock	SCT-20-414	1222.33	1260.91	1302.26	1321.55	1338.09	1373.92	1406.99	1495.19	1573.73	1745.72
Aluminum Base with Lumbar Adjustment - Knit Back											
Back Lock	SCT-20-411	\$1265.57	\$1304.15	\$1345.50	\$1364.79	\$1381.33	\$1417.16	\$1450.23	\$1538.43	\$1616.97	\$1788.96
Forward Tilt/Back Lock	SCT-20-414	1341.37	1379.95	1421.30	1440.59	1457.13	1492.96	1526.03	1614.23	1692.77	1864.76
Aluminum Base with Lumbar Adjustment - Upholstered Back Jacket											
Back Lock	SCT-22-411	\$1291.22	\$1368.38	\$1451.08	\$1489.66	\$1522.74	\$1594.40	\$1660.54	\$1836.94	\$1994.02	\$2338.00
Forward Tilt/Back Lock	SCT-22-414	1367.02	1444.18	1526.88	1565.46	1598.54	1670.20	1736.34	1912.74	2069.82	2413.80

The following options require modification of the product number.

Headrest

Leather Seat with Knit or Mesh Back

Leather Seat with Leather Upholstered Back Jacket

Faux Leather Seat with Knit or Mesh Back

Stain repellent

To specify, change the 3rd digit from a T to an E. Example: SCT-22-7112 with headrest (add \$96.47 list)

To specify, change the 4th digit to 1; **Example:** SCT-10-4011

To specify, change the 4th digit to 1 and 5th digit to 1; **Example:** SCT-11-4011

To specify, change the 4th digit to 3; **Example:** SCT-30-4011

To specify, add P to end of the product number; **Example:** SCT-20-4011P (add \$42.72 list)

NOTE: Stain repellent is available on SCT-20 and SCT-22 models only.

Very Task

Task Chair with Fixed Arms



SCT-20-1011

Dimensions

*SH: 16-21"(406mm-533mm)
 H: 39-44"(991mm-1118mm)
 D: 26"(660mm)
 W: 27"(686mm)
 *SW: 19"(483mm)
 SD: 16"-19"
 (406mm-483mm)
 AH: 8"(203mm)

Low Base:
 14-17"(356mm-432mm)

* Measurements taken with the BIFMA chair measuring device.

Features

- Back: Knit, mesh only or mesh back with upholstered back jacket.
- Seat: Standard upholstered foam (3 lbs. polyurethane foam construction).
- Seat Type: Standard adjustable 3"(76mm) range.
- Base: Plastic base or optional painted five-star aluminum or polished aluminum base.
- Arms: Fixed height arms with aluminum uprights in either painted or polished, soft arm caps.
- Mechanism: Balanced 3-point tilt; standard tilt tension.
- Back Lock: Single position upright back lock.
- Optional Forward Tilt: 5 degrees downward from initial position.
- Optional Asymmetrical Lumbar Adjustment: 4"(102mm) height adjustment; support level can be adjusted independently for right or left hand side of users body.
- Casters: Standard with hard black or two-tone casters; optional soft casters.
- COM yardage / COL square footage:
 Mesh back model: 0.83/20
 Mesh back/upholstered back jacket: 1.5/40

NOTE: When specifying a back jacket; must also specify mesh surface color for outside of back. Back jacket is not field retrofittable. To add a back jacket in the field, see e-Parts for replacement back with an attached jacket.

To Order, Specify:

1) Product number, including:

1 Base/Caster Option:**Aluminum Base**

- 1** Aluminum Std. Base, Hard Caster
- 2** Aluminum Std. Base, Soft Caster, add **\$45.00** to list
- T** Aluminum Std. Base, Two-Tone Casters
- 3** Aluminum Low Base, Hard Caster
- 4** Aluminum Low Base, Soft Caster, add **\$45.00** to list

Plastic Base

- 5** Plastic Std. Base, Hard Caster
- 6** Plastic Std. Base, Soft Caster, add **\$45.00** to list
- P** Plastic Std. Base, Two-Tone Casters

- 2) Fabric surface and color (seat).
- 3) Knit or mesh surface and color (back).
- 4) Back Jacket (if applicable) Fabric surface and color.
- 5) Trim color (plastic components) (arm caps, control cover, adjustment levers, 4D or height adjustable arm uprights).

Note: If TR-UFM is specified, arm caps and adjustment levers default to TR-7 Fog. (Add **\$104.27** list for TR-UFM Snow.)

- 6) Frame trim color (aluminum components - underside of chair).
- 7) Base trim color (plastic or aluminum) dependent upon base style selected; TR-UFM Snow (plastic) and TR-FS Snowfall (aluminum) not available.

Note: If PM-P Polished Aluminum is selected for aluminum frame components (#6) or aluminum base (#7), or both, a total upcharge of **\$213.60** list will apply.

Very Task

Task Chair with Fixed Arms

Upholstered Foam Seat Adjustments	Number ①	Fabric Grade								Leather Grade A	Leather Grade B
		A	B	C	D	E	F	G	H		
Plastic Base - Mesh Back											
Back Lock	SCT-20-101	\$ 967.37	\$1005.95	\$1047.30	\$1066.59	\$1083.13	\$1118.96	\$1152.03	\$1240.23	\$1318.77	\$1490.76
Forward Tilt/Back Lock	SCT-20-104	1043.17	1081.75	1123.10	1142.39	1158.93	1194.76	1227.83	1316.03	1394.57	1566.56
Plastic Base - Knit Back											
Back Lock	SCT-20-101	\$1086.41	\$1124.99	\$1166.34	\$1185.63	\$1202.17	\$1238.00	\$1271.07	\$1359.27	\$1437.81	\$1609.80
Forward Tilt/Back Lock	SCT-20-104	1162.21	1200.79	1242.14	1261.43	1277.97	1313.80	1346.87	1435.07	1513.61	1685.60
Plastic Base - Upholstered Back Jacket											
Back Lock	SCT-22-101	\$1112.06	\$1189.22	\$1271.92	\$1310.50	\$1343.58	\$1415.24	\$1481.38	\$1657.78	\$1814.86	\$2158.84
Forward Tilt/Back Lock	SCT-22-104	1187.86	1265.02	1347.72	1386.30	1419.38	1491.04	1557.18	1733.58	1890.66	2234.64
Plastic Base with Lumbar Adjustment - Mesh Back											
Back Lock	SCT-20-111	\$1063.84	\$1102.42	\$1143.77	\$1163.06	\$1179.60	\$1215.43	\$1248.50	\$1336.70	\$1415.24	\$1587.23
Forward Tilt/Back Lock	SCT-20-114	1139.64	1178.22	1219.57	1238.86	1255.40	1291.23	1324.30	1412.50	1491.04	1663.03
Plastic Base with Lumbar Adjustment - Knit Back											
Back Lock	SCT-20-111	\$1182.88	\$1221.46	\$1262.81	\$1282.10	\$1298.64	\$1334.47	\$1367.54	\$1455.74	\$1534.28	\$1706.27
Forward Tilt/Back Lock	SCT-20-114	1258.68	1297.26	1338.61	1357.90	1374.44	1410.27	1443.34	1531.54	1610.08	1782.07
Plastic Base with Lumbar Adjustment - Upholstered Back Jacket											
Back Lock	SCT-22-111	\$1208.53	\$1285.69	\$1368.39	\$1406.97	\$1440.05	\$1511.71	\$1577.85	\$1754.25	\$1911.33	\$2255.31
Forward Tilt/Back Lock	SCT-22-114	1284.33	1361.49	1444.19	1482.77	1515.85	1587.51	1653.65	1830.05	1987.13	2331.11
Aluminum Base - Mesh Back											
Back Lock	SCT-20-101	\$1036.28	\$1074.86	\$1116.21	\$1135.50	\$1152.04	\$1187.87	\$1220.94	\$1309.14	\$1387.68	\$1559.67
Forward Tilt/Back Lock	SCT-20-104	1112.08	1150.66	1192.01	1211.30	1227.84	1263.67	1296.74	1384.94	1463.48	1635.47
Aluminum Base - Knit Back											
Back Lock	SCT-20-101	\$1155.32	\$1193.90	\$1235.25	\$1254.54	\$1271.08	\$1306.91	\$1339.98	\$1428.18	\$1506.72	\$1678.71
Forward Tilt/Back Lock	SCT-20-104	1231.12	1269.70	1311.05	1330.34	1346.88	1382.71	1415.78	1503.98	1582.52	1754.51
Aluminum Base - Upholstered Back Jacket											
Back Lock	SCT-22-101	\$1180.97	\$1258.13	\$1340.83	\$1379.41	\$1412.49	\$1484.15	\$1550.29	\$1726.69	\$1883.77	\$2227.75
Forward Tilt/Back Lock	SCT-22-104	1256.77	1333.93	1416.63	1455.21	1488.29	1559.95	1626.09	1802.49	1959.57	2303.55
Aluminum Base with Lumbar Adjustment - Mesh Back											
Back Lock	SCT-20-111	\$1132.75	\$1171.33	\$1212.68	\$1231.97	\$1248.51	\$1284.34	\$1317.41	\$1405.61	\$1484.15	\$1656.14
Forward Tilt/Back Lock	SCT-20-114	1208.55	1247.13	1288.48	1307.77	1324.31	1360.14	1393.21	1481.41	1559.95	1731.94
Aluminum Base with Lumbar Adjustment - Knit Back											
Back Lock	SCT-20-111	\$1251.79	\$1290.37	\$1331.72	\$1351.01	\$1367.55	\$1403.38	\$1436.45	\$1524.65	\$1603.19	\$1775.18
Forward Tilt/Back Lock	SCT-20-114	1327.59	1366.17	1407.52	1426.81	1443.35	1479.18	1512.25	1600.45	1678.99	1850.98
Aluminum Base with Lumbar Adjustment - Upholstered Back Jacket											
Back Lock	SCT-22-111	\$1277.44	\$1354.60	\$1437.30	\$1475.88	\$1508.96	\$1580.62	\$1646.76	\$1823.16	\$1980.24	\$2324.22
Forward Tilt/Back Lock	SCT-22-114	1353.24	1430.40	1513.10	1551.68	1584.76	1656.42	1722.56	1898.96	2056.04	2400.02

The following options require modification of the product number.

Headrest

Leather Seat with Knit or Mesh Back

Leather Seat with Leather Upholstered Back Jacket

Faux Leather Seat with Knit or Mesh Back

Stain repellent

To specify, change the 3rd digit from a T to an E. Example: SCE-22-7112 with headrest (add \$96.47 list)

To specify, change the 4th digit to 1; **Example:** SCT-10-1011

To specify, change the 4th digit to 1 and 5th digit to 1; **Example:** SCT-11-1011

To specify, change the 4th digit to 3; **Example:** SCT-30-1011

To specify, add P to end of the product number; **Example:** SCT-20-1011P (add \$42.72 list)

NOTE: Stain repellent is available on SCT-20 and SCT-22 models only.

Very Task

Task Chair without Arms



SCT-20-0011

Dimensions

*SH: 16-21"(406mm-533mm)
 H: 39-44"(991mm-1118mm)
 D: 26"(660mm)
 W: 27"(686mm)
 *SW: 19"(483mm)
 SD: 16"-19"
 (406mm-483mm)

Low Base:
 14-17"(356mm-432mm)

* Measurements taken with the BIFMA chair measuring device.

Features

- Back: Knit, mesh only or mesh back with upholstered back jacket.
- Seat: Standard upholstered foam (3 lbs. polyurethane foam construction).
- Seat Type: Standard adjustable 3"(76mm) range.
- Base: Plastic base or optional painted five-star aluminum or polished aluminum base.
- Mechanism: Balanced 3-point tilt; standard tilt tension.
- Back Lock: Single position upright back lock.
- Optional Forward Tilt: 5 degrees downward from initial position.
- Optional Asymmetrical Lumbar Adjustment: 4"(102mm) height adjustment; support level can be adjusted independently for right or left hand side of users body.
- Casters: Standard with hard black or two-tone casters; optional soft casters.
- COM yardage / COL square footage:
 Mesh back model: 0.83/20
 Mesh back/upholstered back jacket: 1.5/40

NOTE: When specifying a back jacket; must also specify mesh surface color for outside of back. Back jacket is not field retrofittable. To add a back jacket in the field, see e-Parts for replacement back with an attached jacket.

To Order, Specify:

1) Product number, including:

1 Base/Caster Option:**Aluminum Base**

- 1** Aluminum Std. Base, Hard Caster
- 2** Aluminum Std. Base, Soft Caster, add **\$45.00** to list
- T** Aluminum Std. Base, Two-Tone Casters
- 3** Aluminum Low Base, Hard Caster
- 4** Aluminum Low Base, Soft Caster, add **\$45.00** to list

Plastic Base

- 5** Plastic Std. Base, Hard Caster
- 6** Plastic Std. Base, Soft Caster, add **\$45.00** to list
- P** Plastic Std. Base, Two-Tone Casters

- 2) Fabric surface and color (seat).
- 3) Knit or mesh surface and color (back).
- 4) Back Jacket (if applicable) Fabric surface and color.
- 5) Trim color (plastic components) (arm caps, control cover, adjustment levers, 4D or height adjustable arm uprights).

Note: If TR-UFM is specified, arm caps and adjustment levers default to TR-7 Fog. (Add **\$104.27** list for TR-UFM Snow.)

- 6) Frame trim color (aluminum components - underside of chair).
- 7) Base trim color (plastic or aluminum) dependent upon base style selected; TR-UFM Snow (plastic) and TR-FS Snowfall (aluminum) not available.

Note: If PM-P Polished Aluminum is selected for aluminum frame components (#6) or aluminum base (#7), or both, a total upcharge of **\$213.60** list will apply.

Very Task

Task Chair without Arms

Upholstered Foam Seat Adjustments	Number ①	Fabric Grade								Leather Grade A	Leather Grade B
		A	B	C	D	E	F	G	H		
Plastic Base - Mesh Back											
Back Lock	SCT-20-001	\$ 808.90	\$ 847.48	\$ 888.83	\$ 908.12	\$ 924.66	\$ 960.49	\$ 993.56	\$1081.76	\$1160.30	\$1332.29
Forward Tilt/Back Lock	SCT-20-004	884.70	923.28	964.63	983.92	1000.46	1036.29	1069.36	1157.56	1236.10	1408.09
Plastic Base - Knit Back											
Back Lock	SCT-20-001	\$ 927.94	\$ 966.52	\$1007.87	\$1027.16	\$1043.70	\$1079.53	\$1112.60	\$1200.80	\$1279.34	\$1451.33
Forward Tilt/Back Lock	SCT-20-004	1003.74	1042.32	1083.67	1102.96	1119.50	1155.33	1188.40	1276.60	1355.14	1527.13
Plastic Base - Upholstered Back Jacket											
Back Lock	SCT-22-001	\$ 953.59	\$1030.75	\$1113.45	\$1152.03	\$1185.11	\$1256.77	\$1322.91	\$1499.31	\$1656.39	\$2000.37
Forward Tilt/Back Lock	SCT-22-004	1029.39	1106.55	1189.25	1227.83	1260.91	1332.57	1398.71	1575.11	1732.19	2076.17
Plastic Base with Lumbar Adjustment - Mesh Back											
Back Lock	SCT-20-011	\$ 905.37	\$ 943.95	\$ 985.30	\$1004.59	\$1021.13	\$1056.96	\$1090.03	\$1178.23	\$1256.77	\$1428.76
Forward Tilt/Back Lock	SCT-20-014	981.17	1019.75	1061.10	1080.39	1096.93	1132.76	1165.83	1254.03	1332.57	1504.56
Plastic Base with Lumbar Adjustment - Knit Back											
Back Lock	SCT-20-011	\$1024.41	\$1062.99	\$1104.34	\$1123.63	\$1140.17	\$1176.00	\$1209.07	\$1297.27	\$1375.81	\$1547.80
Forward Tilt/Back Lock	SCT-20-014	1100.21	1138.79	1180.14	1199.43	1215.97	1251.80	1284.87	1373.07	1451.61	1623.60
Plastic Base with Lumbar Adjustment - Upholstered Back Jacket											
Back Lock	SCT-22-011	\$1050.06	\$1127.22	\$1209.92	\$1248.50	\$1281.58	\$1353.24	\$1419.38	\$1595.78	\$1752.86	\$2096.84
Forward Tilt/Back Lock	SCT-22-014	1125.86	1203.02	1285.72	1324.30	1357.38	1429.04	1495.18	1671.58	1828.66	2172.64
Aluminum Base - Mesh Back											
Back Lock	SCT-20-001	\$ 877.81	\$ 916.39	\$ 957.74	\$ 977.03	\$ 993.57	\$1029.40	\$1062.47	\$1150.67	\$1229.21	\$1401.20
Forward Tilt/Back Lock	SCT-20-004	953.61	992.19	1033.54	1052.83	1069.37	1105.20	1138.27	1226.47	1305.01	1477.00
Aluminum Base - Knit Back											
Back Lock	SCT-20-001	\$ 996.85	\$1035.43	\$1076.78	\$1096.07	\$1112.61	\$1148.44	\$1181.51	\$1269.71	\$1348.25	\$1520.24
Forward Tilt/Back Lock	SCT-20-004	1072.65	1111.23	1152.58	1171.87	1188.41	1224.24	1257.31	1345.51	1424.05	1596.04
Aluminum Base - Upholstered Back Jacket											
Back Lock	SCT-22-001	\$1022.50	\$1099.66	\$1182.36	\$1220.94	\$1254.02	\$1325.68	\$1391.82	\$1568.22	\$1725.30	\$2069.28
Forward Tilt/Back Lock	SCT-22-004	1098.30	1175.46	1258.16	1296.74	1329.82	1401.48	1467.62	1644.02	1801.10	2145.08
Aluminum Base with Lumbar Adjustment - Mesh Back											
Back Lock	SCT-20-011	\$ 974.28	\$1012.86	\$1054.21	\$1073.50	\$1090.04	\$1125.87	\$1158.94	\$1247.14	\$1325.68	\$1497.67
Forward Tilt/Back Lock	SCT-20-014	1050.08	1088.66	1130.01	1149.30	1165.84	1201.67	1234.74	1322.94	1401.48	1573.47
Aluminum Base with Lumbar Adjustment - Knit Back											
Back Lock	SCT-20-011	\$1093.32	\$1131.90	\$1173.25	\$1192.54	\$1209.08	\$1244.91	\$1277.98	\$1366.18	\$1444.72	\$1616.71
Forward Tilt/Back Lock	SCT-20-014	1169.12	1207.70	1249.05	1268.34	1284.88	1320.71	1353.78	1441.98	1520.52	1692.51
Aluminum Base with Lumbar Adjustment - Upholstered Back Jacket											
Back Lock	SCT-22-011	\$1118.97	\$1196.13	\$1278.83	\$1317.41	\$1350.49	\$1422.15	\$1488.29	\$1664.69	\$1821.77	\$2165.75
Forward Tilt/Back Lock	SCT-22-014	1194.77	1271.93	1354.63	1393.21	1426.29	1497.95	1564.09	1740.49	1897.57	2241.55

The following options require modification of the product number.

Headrest

Leather Seat with Knit or Mesh Back

Leather Seat with Leather Upholstered Back Jacket

Faux Leather Seat with Knit or Mesh Back

Stain repellent

To specify, change the 3rd digit from a T to an E. Example: SCT-22-7112 with headrest (add \$96.47 list)

To specify, change the 4th digit to 1; **Example:** SCT-10-0011

To specify, change the 4th digit to 1 and 5th digit to 1; **Example:** SCT-11-0011

To specify, change the 4th digit to 3; **Example:** SCT-30-0011

To specify, add P to end of the product number; **Example:** SCT-20-0011P (add \$42.72 list)

NOTE: Stain repellent is available on SCT-20 and SCT-22 models only.

Very Task

Task Stool with 4D Arms



SCTC-20-7011

Dimensions

- *SH: 20-28"
(508mm-711mm)
- H: 43-51"
(1092mm-1295mm)
- D: 26"(660mm)
- W: 27"(686mm)
- *SW: 19"(483mm)
- SD: 16"-19"
(406mm-483mm)
- AH: 6.5"-10.5"
(165mm-267mm)

* Measurements taken with the BIFMA chair measuring device.

Features

- Back: Knit, mesh or mesh back with upholstered back jacket.
- Seat: Standard upholstered foam (3 lbs. polyurethane foam construction).
- Base: Plastic base or optional painted five-star aluminum or polished aluminum base.
- Arms: 4D with soft arm caps. Arm adjusts up and down, side to side, front to back and pivot in and out.
- Mechanism: Balanced 3-point tilt; standard tilt tension.
- Back Lock: Single position upright back lock.
- Optional Asymmetrical Lumbar Adjustment: 4"(102mm) height adjustment; support level can be adjusted independently for right or left hand side of users body.
- Casters: Standard with hard black or two-tone casters; optional soft casters.
- Adjustable height foot ring.
- COM yardage / COL square footage:
Mesh back model: 0.83/20
Mesh back/upholstered back jacket: 1.5/40

NOTE: When specifying a back jacket; must also specify mesh surface color for outside of back. Back jacket is not field retrofittable. To add a back jacket in the field, see e-Parts for replacement back with an attached jacket.

To Order, Specify:

1) Product number, including:

1 Base/Caster Option:

Aluminum Base

- 1** Aluminum Std. Base, Hard Caster
- 2** Aluminum Std. Base, Soft Caster, add **\$45.00** to list
- T** Aluminum Std. Base, Two-Tone Casters

Plastic Base

- 5** Plastic Std. Base, Hard Caster
- 6** Plastic Std. Base, Soft Caster, add **\$45.00** to list
- P** Plastic Std. Base, Two-Tone Casters

- 2) Fabric surface and color (seat).
- 3) Knit or mesh surface and color (back).
- 4) Back Jacket (if applicable) Fabric surface and color.
- 5) Trim color (plastic components) (arm caps, control cover, adjustment levers, 4D or height adjustable arm uprights).

Note: If TR-UFM is specified, arm caps and adjustment levers default to TR-7 Fog. (Add **\$104.27** list for TR-UFM Snow.)

- 6) Frame trim color (aluminum components - underside of chair).
- 7) Base trim color (plastic or aluminum) dependent upon base style selected; TR-UFM Snow (plastic) and TR-FS Snowfall (aluminum) not available.

Note: If PM-P Polished Aluminum is selected for aluminum frame components (#6) or aluminum base (#7), or both, a total upcharge of **\$213.60** list will apply.

Very Task

Task Stool with 4D Arms

Upholstered Seat Adjustments	Number ①	Fabric Grade								Leather Grade A	Leather Grade B
		A	B	C	D	E	F	G	H		
Plastic Base											
Mesh Back/Back Lock	SCTC-20-701	\$1526.79	\$1565.37	\$1606.72	\$1626.01	\$1642.55	\$1678.38	\$1711.45	\$1799.65	\$1878.19	\$2050.18
Knit Back/Back Lock	SCTC-20-701	1645.83	1684.41	1725.76	1745.05	1761.59	1797.42	1830.49	1918.69	1997.23	2169.22
Upholstered Back Jacket/Back Lock	SCTC-22-701	1671.48	1748.64	1831.34	1869.92	1903.00	1974.66	2040.80	2217.20	2374.28	2718.26
Plastic Base with Lumbar Adjustment											
Mesh Back/Back Lock	SCTC-20-711	\$1623.26	\$1661.84	\$1703.19	\$1722.48	\$1739.02	\$1774.85	\$1807.92	\$1896.12	\$1974.66	\$2146.65
Knit Back/Back Lock	SCTC-20-711	1742.30	1780.88	1822.23	1841.52	1858.06	1893.89	1926.96	2015.16	2093.70	2265.69
Upholstered Back Jacket/Back Lock	SCTC-22-711	1767.95	1845.11	1927.81	1966.39	1999.47	2071.13	2137.27	2313.67	2470.75	2814.73
Aluminum Base											
Mesh Back/Back Lock	SCTC-20-701	\$1595.70	\$1634.28	\$1675.63	\$1694.92	\$1711.46	\$1747.29	\$1780.36	\$1868.56	\$1947.10	\$2119.09
Knit Back/Back Lock	SCTC-20-701	1714.74	1753.32	1794.67	1813.96	1830.50	1866.33	1899.40	1987.60	2066.14	2238.13
Upholstered Back Jacket/Back Lock	SCTC-22-701	1740.39	1817.55	1900.25	1938.83	1971.91	2043.57	2109.71	2286.11	2443.19	2787.17
Aluminum Base with Lumbar Adjustment											
Mesh Back/Back Lock	SCTC-20-711	\$1692.17	\$1730.75	\$1772.10	\$1791.39	\$1807.93	\$1843.76	\$1876.83	\$1965.03	\$2043.57	\$2215.56
Knit Back/Back Lock	SCTC-20-711	1811.21	1849.79	1891.14	1910.43	1926.97	1962.80	1995.87	2084.07	2162.61	2334.60
Upholstered Back Jacket/Back Lock	SCTC-22-711	1836.86	1914.02	1996.72	2035.30	2068.38	2140.04	2206.18	2382.58	2539.66	2883.64

The following options require modification of the product number.

Leather Seat with Knit or Mesh Back	To specify, change the 5th digit to 1 ; Example: SCTC-10-0011
Leather Seat with Leather Upholstered Back Jacket	To specify, change the 5th digit to 1 and 6th digit to 1 ; Example: SCTC-11-0011
Faux Leather Seat with Knit or Mesh Back	To specify, change the 5th digit to 3 ; Example: SCTC-30-0011
Stain repellent	To specify, add P to end of the product number; Example: SCTC-20-0011 P (add \$42.72 list)

NOTE: Stain repellent is available on SCTC-20 and SCTC-22 models only.

Very Task

Task Stool with Height Adjustable Arms



SCTC-20-4011

Dimensions

- *SH: 20-28"
(508mm-711mm)
- H: 43-51"
(1092mm-1295mm)
- D: 26"(660mm)
- W: 27"(686mm)
- *SW: 19"(483mm)
- SD: 16"-19"
(406mm-483mm)
- AH: 6.5"-10.5"
(165mm-267mm)

* Measurements taken with the BIFMA chair measuring device.

Features

- Back: Knit, mesh only or mesh back with upholstered back jacket.
- Seat: Standard upholstered foam (3 lbs. polyurethane foam construction).
- Base: Plastic base or optional painted five-star aluminum or polished aluminum base.
- Arms: Height-adjustable arms with plastic uprights (black or fog) with soft arm caps. Height adjustment range of 4"(102mm).
- Mechanism: Balanced 3-point tilt; standard tilt tension.
- Back Lock: Single position upright back lock.
- Optional Asymmetrical Lumbar Adjustment: 4"(102mm) height adjustment; support level can be adjusted independently for right or left hand side of users body.
- Casters: Standard with hard black or two-tone casters; optional soft casters.
- Adjustable height foot ring.
- COM yardage / COL square footage:
Mesh back model: 0.83/20
Mesh back/upholstered back jacket: 1.5/40

NOTE: When specifying a back jacket; must also specify mesh surface color for outside of back. Back jacket is not field retrofittable. To add a back jacket in the field, see e-Parts for replacement back with an attached jacket.

To Order, Specify:

1) Product number, including:

1 Base/Caster Option:

Aluminum Base

- 1** Aluminum Std. Base, Hard Caster
- 2** Aluminum Std. Base, Soft Caster, add **\$45.00** to list
- T** Aluminum Std. Base, Two-Tone Casters

Plastic Base

- 5** Plastic Std. Base, Hard Caster
- 6** Plastic Std. Base, Soft Caster, add **\$45.00** to list
- P** Plastic Std. Base, Two-Tone Casters

2) Fabric surface and color (seat).

3) Knit or mesh surface and color (back).

4) Back Jacket (if applicable) Fabric surface and color.

5) Trim color (plastic components) (arm caps, control cover, adjustment levers, 4D or height adjustable arm uprights).

Note: If TR-UFM is specified, arm caps and adjustment levers default to TR-7 Fog. (Add **\$104.27** list for TR-UFM Snow.)

6) Frame trim color (aluminum components - underside of chair).

7) Base trim color (plastic or aluminum) dependent upon base style selected; TR-UFM Snow (plastic) and TR-FS Snowfall (aluminum) not available.

Note: If PM-P Polished Aluminum is selected for aluminum frame components (#6) or aluminum base (#7), or both, a total upcharge of **\$213.60** list will apply.

Very Task

Task Stool with Height Adjustable Arms

Upholstered Foam Seat Adjustments	Number ①	Fabric Grade								Leather Grade A	Leather Grade B
		A	B	C	D	E	F	G	H		
Plastic Base											
Mesh Back/Back Lock	SCTC-20-401	\$1457.88	\$1496.46	\$1537.81	\$1557.10	\$1573.64	\$1609.47	\$1642.54	\$1730.74	\$1809.28	\$1981.27
Knit Back/Back Lock	SCTC-20-401	1576.92	1615.50	1656.85	1676.14	1692.68	1728.51	1761.58	1849.78	1928.32	2100.31
Upholstered Back Jacket/Back Lock	SCTC-22-401	1602.57	1679.73	1762.43	1801.01	1834.09	1905.75	1971.89	2148.29	2305.37	2649.35
Plastic Base with Lumbar Adjustment											
Mesh Back/Back Lock	SCTC-20-411	\$1554.35	\$1592.93	\$1634.28	\$1653.57	\$1670.11	\$1705.94	\$1739.01	\$1827.21	\$1905.75	\$2077.74
Knit Back/Back Lock	SCTC-20-411	1673.39	1711.97	1753.32	1772.61	1789.15	1824.98	1858.05	1946.25	2024.79	2196.78
Upholstered Back Jacket/Back Lock	SCTC-22-411	1699.04	1776.20	1858.90	1897.48	1930.56	2002.22	2068.36	2244.76	2401.84	2745.82
Aluminum Base											
Mesh Back/Back Lock	SCTC-20-401	\$1526.79	\$1565.37	\$1606.72	\$1626.01	\$1642.55	\$1678.38	\$1711.45	\$1799.65	\$1878.19	\$2050.18
Knit Back/Back Lock	SCTC-20-401	1645.83	1684.41	1725.76	1745.05	1761.59	1797.42	1830.49	1918.69	1997.23	2169.22
Upholstered Back Jacket/Back Lock	SCTC-22-401	1671.48	1748.64	1831.34	1869.92	1903.00	1974.66	2040.80	2217.20	2374.28	2718.26
Aluminum Base with Lumbar Adjustment											
Mesh Back/Back Lock	SCTC-20-411	\$1623.26	\$1661.84	\$1703.19	\$1722.48	\$1739.02	\$1774.85	\$1807.92	\$1896.12	\$1974.66	\$2146.65
Knit Back/Back Lock	SCTC-20-411	1742.30	1780.88	1822.23	1841.52	1858.06	1893.89	1926.96	2015.16	2093.70	2265.69
Upholstered Back Jacket/Back Lock	SCTC-22-411	1767.95	1845.11	1927.81	1966.39	1999.47	2071.13	2137.27	2313.67	2470.75	2814.73

The following options require modification of the product number.

Leather Seat with Knit or Mesh Back

To specify, change the 5th digit to **1**; **Example:** SCTC-10-4011

Leather Seat with Leather Upholstered Back Jacket

To specify, change the 5th digit to **1** and 6th digit to **1**; **Example:** SCTC-11-4011

Faux Leather Seat with Knit or Mesh Back

To specify, change the 5th digit to **3**; **Example:** SCTC-30-4011

Stain repellent

To specify, add **P** to end of the product number; **Example:** SCTC-20-4011P (add \$42.72 list)

NOTE: Stain repellent is available on SCTC-20 and SCTC-22 models only.

Very Task

Task Stool with Fixed Arms



SCTC-20-1011

Dimensions

- *SH: 20-28"
(508mm-711mm)
- H: 43-51"
(1092mm-1295mm)
- D: 26"(660mm)
- W: 27"(686mm)
- *SW: 19"(483mm)
- SD: 16"-19"
(406mm-483mm)
- AH: 8"(203mm)

* Measurements taken with the BIFMA chair measuring device.

Features

- Back: Knit, mesh only or mesh back with upholstered back jacket.
- Seat: Standard upholstered foam (3 lbs. polyurethane foam construction).
- Seat Type: Standard adjustable 3"(76mm) range.
- Base: Plastic base or optional painted five-star aluminum or polished aluminum base.
- Arms: Fixed height arms with aluminum uprights in either painted or polished, soft arm caps.
- Mechanism: Balanced 3-point tilt; standard tilt tension.
- Back Lock: Single position upright back lock.
- Optional Asymmetrical Lumbar Adjustment: 4"(102mm) height adjustment; support level can be adjusted independently for right or left hand side of users body.
- Casters: Standard with hard black or two-tone casters; optional soft casters.
- Adjustable height foot ring.
- COM yardage / COL square footage:
Mesh back model: 0.83/20
Mesh back/upholstered back jacket: 1.5/40

NOTE: When specifying a back jacket; must also specify mesh surface color for outside of back. Back jacket is not field retrofittable. To add a back jacket in the field, see e-Parts for replacement back with an attached jacket.

To Order, Specify:

1) Product number, including:

1 Base/Caster Option:

Aluminum Base

- 1** Aluminum Std. Base, Hard Caster
- 2** Aluminum Std. Base, Soft Caster, add **\$45.00** to list
- T** Aluminum Std. Base, Two-Tone Casters

Plastic Base

- 5** Plastic Std. Base, Hard Caster
- 6** Plastic Std. Base, Soft Caster, add **\$45.00** to list
- P** Plastic Std. Base, Two-Tone Casters

2) Fabric surface and color (seat).

3) Knit or mesh surface and color (back).

4) Back Jacket (if applicable) Fabric surface and color.

5) Trim color (plastic components) (arm caps, control cover, adjustment levers, 4D or height adjustable arm uprights).

Note: If TR-UFM is specified, arm caps and adjustment levers default to TR-7 Fog. (Add **\$104.27** list for TR-UFM Snow.)

6) Frame trim color (aluminum components - underside of chair).

7) Base trim color (plastic or aluminum) dependent upon base style selected; TR-UFM Snow (plastic) and TR-FS Snowfall (aluminum) not available.

Note: If PM-P Polished Aluminum is selected for aluminum frame components (#6) or aluminum base (#7), or both, a total upcharge of **\$213.60** list will apply.

Very Task

Task Stool with Fixed Arms

Upholstered Foam Seat Adjustments	Number ①	Fabric Grade								Leather Grade A	Leather Grade B
		A	B	C	D	E	F	G	H		
Plastic Base											
Mesh Back/Back Lock	SCTC-20-101	\$1444.10	\$1482.68	\$1524.03	\$1543.32	\$1559.86	\$1595.69	\$1628.76	\$1716.96	\$1795.50	\$1967.49
Knit Back/Back Lock	SCTC-20-101	1563.14	1601.72	1643.07	1662.36	1678.90	1714.73	1747.80	1836.00	1914.54	2086.53
Upholstered Back Jacket/Back Lock	SCTC-22-101	1588.79	1665.95	1748.65	1787.23	1820.31	1891.97	1958.11	2134.51	2291.59	2635.57
Plastic Base with Lumbar Adjustment											
Mesh Back/Back Lock	SCTC-20-111	\$1540.57	\$1579.15	\$1620.50	\$1639.79	\$1656.33	\$1692.16	\$1725.23	\$1813.43	\$1891.97	\$2063.96
Knit Back/Back Lock	SCTC-20-111	1659.61	1698.19	1739.54	1758.83	1775.37	1811.20	1844.27	1932.47	2011.01	2183.00
Upholstered Back Jacket/Back Lock	SCTC-22-111	1685.26	1762.42	1845.12	1883.70	1916.78	1988.44	2054.58	2230.98	2388.06	2732.04
Aluminum Base											
Mesh Back/Back Lock	SCTC-20-101	\$1513.01	\$1551.59	\$1592.94	\$1612.23	\$1628.77	\$1664.60	\$1697.67	\$1785.87	\$1864.41	\$2036.40
Knit Back/Back Lock	SCTC-20-101	1632.05	1670.63	1711.98	1731.27	1747.81	1783.64	1816.71	1904.91	1983.45	2155.44
Upholstered Back Jacket/Back Lock	SCTC-22-101	1657.70	1734.86	1817.56	1856.14	1889.22	1960.88	2027.02	2203.42	2360.50	2704.48
Aluminum Base with Lumbar Adjustment											
Mesh Back/Back Lock	SCTC-20-111	\$1609.48	\$1648.06	\$1689.41	\$1708.70	\$1725.24	\$1761.07	\$1794.14	\$1882.34	\$1960.88	\$2132.87
Knit Back/Back Lock	SCTC-20-111	1728.52	1767.10	1808.45	1827.74	1844.28	1880.11	1913.18	2001.38	2079.92	2251.91
Upholstered Back Jacket/Back Lock	SCTC-22-111	1754.17	1831.33	1914.03	1952.61	1985.69	2057.35	2123.49	2299.89	2456.97	2800.95

The following options require modification of the product number.

Leather Seat with Knit or Mesh Back

To specify, change the 5th digit to **1**; **Example:** SCTC-10-1011

Leather Seat with Leather Upholstered Back Jacket

To specify, change the 5th digit to **1** and 6th digit to **1**; **Example:** SCTC-11-1011

Faux Leather Seat with Knit or Mesh Back

To specify, change the 5th digit to **3**; **Example:** SCTC-30-1011

Stain repellent

To specify, add **P** to end of the product number; **Example:** SCTC-20-1011**P** (add **\$42.72** list)

NOTE: Stain repellent is available on SCTC-20 and SCTC-22 models only.

Very Task

Task Stool without Arms



SCTC-20-0011

Dimensions

- *SH: 20-28"
(508mm-711mm)
- H: 43-51"
(1092mm-12958mm)
- D: 26"(660mm)
- W: 27"(686mm)
- *SW: 19"(483mm)
- SD: 16"-19"
(406mm-483mm)

* Measurements taken with the BIFMA chair measuring device.

Features

- Back: Knit, mesh only or mesh back with upholstered back jacket.
- Seat: Standard upholstered foam (3 lbs. polyurethane foam construction).
- Seat Type: Standard adjustable 3"(76mm) range.
- Base: Plastic base or optional painted five-star aluminum or polished aluminum base.
- Mechanism: Balanced 3-point tilt; standard tilt tension.
- Back Lock: Single position upright back lock.
- Optional Asymmetrical Lumbar Adjustment: 4"(102mm) height adjustment; support level can be adjusted independently for right or left hand side of users body.
- Casters: Standard with hard black or two-tone casters; optional soft casters.
- Adjustable height foot ring.
- COM yardage / COL square footage:
Mesh back model: 0.83/20
Mesh back/upholstered back jacket: 1.5/40

NOTE: When specifying a back jacket; must also specify mesh surface color for outside of back. Back jacket is not field retrofittable. To add a back jacket in the field, see e-Parts for replacement back with an attached jacket.

To Order, Specify:

- 1) Product number, including:

1 Base/Caster Option:

Aluminum Base

- 1** Aluminum Std. Base, Hard Caster
- 2** Aluminum Std. Base, Soft Caster, add **\$45.00** to list
- T** Aluminum Std. Base, Two-Tone Casters

Plastic Base

- 5** Plastic Std. Base, Hard Caster
- 6** Plastic Std. Base, Soft Caster, add **\$45.00** to list
- P** Plastic Std. Base, Two-Tone Casters

- 2) Fabric surface and color (seat).
- 3) Knit or mesh surface and color (back).
- 4) Back Jacket (if applicable) Fabric surface and color.
- 5) Trim color (plastic components) (arm caps, control cover, adjustment levers, 4D or height adjustable arm uprights).

Note: If TR-UFM is specified, arm caps and adjustment levers default to TR-7 Fog. (Add **\$104.27** list for TR-UFM Snow.)

- 6) Frame trim color (aluminum components - underside of chair).
- 7) Base trim color (plastic or aluminum) dependent upon base style selected; TR-UFM Snow (plastic) and TR-FS Snowfall (aluminum) not available.

Note: If PM-P Polished Aluminum is selected for aluminum frame components (#6) or aluminum base (#7), or both, a total upcharge of **\$213.60** list will apply.

Very Task

Task Stool without Arms

Upholstered Foam Seat Adjustments	Number ①	Fabric Grade								Leather Grade A	Leather Grade B
		A	B	C	D	E	F	G	H		
Plastic Base											
Mesh Back/Back Lock	SCTC-20-001	\$1285.63	\$1324.21	\$1365.56	\$1384.85	\$1401.39	\$1437.22	\$1470.29	\$1558.49	\$1637.03	\$1809.02
Knit Back/Back Lock	SCTC-20-001	1404.67	1443.25	1484.60	1503.89	1520.43	1556.26	1589.33	1677.53	1756.07	1928.06
Upholstered Back Jacket/Back Lock	SCTC-22-001	1430.32	1507.48	1590.18	1628.76	1661.84	1733.50	1799.64	1976.04	2133.12	2477.10
Plastic Base with Lumbar Adjustment											
Mesh Back/Back Lock	SCTC-20-011	\$1382.10	\$1420.68	\$1462.03	\$1481.32	\$1497.86	\$1533.69	\$1566.76	\$1654.96	\$1733.50	\$1905.49
Knit Back/Back Lock	SCTC-20-011	1501.14	1539.72	1581.07	1600.36	1616.90	1652.73	1685.80	1774.00	1852.54	2024.53
Upholstered Back Jacket/Back Lock	SCTC-22-011	1526.79	1603.95	1686.65	1725.23	1758.31	1829.97	1896.11	2072.51	2229.59	2573.57
Aluminum Base											
Mesh Back/Back Lock	SCTC-20-001	\$1354.54	\$1393.12	\$1434.47	\$1453.76	\$1470.30	\$1506.13	\$1539.20	\$1627.40	\$1705.94	\$1877.93
Knit Back/Back Lock	SCTC-20-001	1473.58	1512.16	1553.51	1572.80	1589.34	1625.17	1658.24	1746.44	1824.98	1996.97
Upholstered Back Jacket/Back Lock	SCTC-22-001	1499.23	1576.39	1659.09	1697.67	1730.75	1802.41	1868.55	2044.95	2202.03	2546.01
Aluminum Base with Lumbar Adjustment											
Mesh Back/Back Lock	SCTC-20-011	\$1451.01	\$1489.59	\$1530.94	\$1550.23	\$1566.77	\$1602.60	\$1635.67	\$1723.87	\$1802.41	\$1974.40
Knit Back/Back Lock	SCTC-20-011	1570.05	1608.63	1649.98	1669.27	1685.81	1721.64	1754.71	1842.91	1921.45	2093.44
Upholstered Back Jacket/Back Lock	SCTC-22-011	1595.70	1672.86	1755.56	1794.14	1827.22	1898.88	1965.02	2141.42	2298.50	2642.48

The following options require modification of the product number.

Leather Seat with Knit or Mesh Back

To specify, change the 5th digit to **1**; **Example:** SCTC-10-0011

Leather Seat with Leather Upholstered Back Jacket

To specify, change the 5th digit to **1** and 6th digit to **1**; **Example:** SCTC-11-0011

Faux Leather Seat with Knit or Mesh Back

To specify, change the 5th digit to **3**; **Example:** SCTC-30-0011

Stain repellent

To specify, add **P** to end of the product number; **Example:** SCTC-20-0011P (add **\$42.72** list)

NOTE: Stain repellent is available on SCTC-20 and SCTC-22 models only.

This page intentionally blank

Very Wire Stacker

General Specifications

Features and Options (Wire Stacker and Wire Stool)

Wire Stacker Chair

- 11mm solid steel rod frame
- Single piece high-strength polymer shell seat and back
- Clear nylon glides
- Frame finishes include: painted or Trivalent chrome
- Optional upholstered foam pad on seat or seat and back
- Fog or black trim arm caps
- Arm or armless version available
- Arm chair stacks 5-high on the floor or 15-high on a cart. Dimensions for 15-high on cart: 54"(1372mm)H x 55"(1397mm)D x 24"(610mm)W.
- Armless stacks 10-high on the floor, upholstered or non-upholstered; stacks 30-high non-upholstered on a cart (63.5"(1613mm)H x 37"(940mm)D x 24"(610mm)W); stacks 25-high upholstered on a cart (61"(1549mm)H x 40.5"(1029mm)D x 24"(610mm)W).
- Seat: Stitched double seams. Vertically in the center and on the edges of the leather seat cushion.
- Ganging option: arm chair to armless, armless to armless.
- Chairs with arms: 16 lbs.
- Chairs without arms: 15 lbs.

Wire Stacker Stool

- Chrome frame
- Stacks 5-high on the floor.
- Single piece high-strength polymer shell seat and back
- Clear nylon glides
- Fog or black trim arm caps
- Arm or armless version available

General Guidelines for Product Specification

	<u>S</u>	<u>C</u>	<u>H</u>	<u>-</u>	<u>2</u>	<u>2</u>	<u>-</u>	<u>3</u>	<u>S</u>	<u>E</u>	<u>3A-18</u>	<u>3A-18</u>	<u>TR-FA</u>	<u>TR-F</u>	<u>KR-V</u>
Product Type	_____	_____	_____	_____	_____	_____	_____	_____	_____	_____	_____	_____	_____	_____	_____
(S) Seating	_____	_____	_____	_____	_____	_____	_____	_____	_____	_____	_____	_____	_____	_____	_____
Product Line	_____	_____	_____	_____	_____	_____	_____	_____	_____	_____	_____	_____	_____	_____	_____
(C) Very	_____	_____	_____	_____	_____	_____	_____	_____	_____	_____	_____	_____	_____	_____	_____
Model	_____	_____	_____	_____	_____	_____	_____	_____	_____	_____	_____	_____	_____	_____	_____
(H) Wire Stack	_____	_____	_____	_____	_____	_____	_____	_____	_____	_____	_____	_____	_____	_____	_____
(W) Stool	_____	_____	_____	_____	_____	_____	_____	_____	_____	_____	_____	_____	_____	_____	_____
Seat Upholstery	_____	_____	_____	_____	_____	_____	_____	_____	_____	_____	_____	_____	_____	_____	_____
(1) Leather	_____	_____	_____	_____	_____	_____	_____	_____	_____	_____	_____	_____	_____	_____	_____
(2) Fabric	_____	_____	_____	_____	_____	_____	_____	_____	_____	_____	_____	_____	_____	_____	_____
(3) Faux Leather	_____	_____	_____	_____	_____	_____	_____	_____	_____	_____	_____	_____	_____	_____	_____
(4) Polymer	_____	_____	_____	_____	_____	_____	_____	_____	_____	_____	_____	_____	_____	_____	_____
Back Upholstery	_____	_____	_____	_____	_____	_____	_____	_____	_____	_____	_____	_____	_____	_____	_____
(1) Leather	_____	_____	_____	_____	_____	_____	_____	_____	_____	_____	_____	_____	_____	_____	_____
(2) Fabric	_____	_____	_____	_____	_____	_____	_____	_____	_____	_____	_____	_____	_____	_____	_____
(3) Faux Leather	_____	_____	_____	_____	_____	_____	_____	_____	_____	_____	_____	_____	_____	_____	_____
(4) Polymer	_____	_____	_____	_____	_____	_____	_____	_____	_____	_____	_____	_____	_____	_____	_____
Arm/Caps	_____	_____	_____	_____	_____	_____	_____	_____	_____	_____	_____	_____	_____	_____	_____
(0) No Arms	_____	_____	_____	_____	_____	_____	_____	_____	_____	_____	_____	_____	_____	_____	_____
(3) Fixed Arms, Hard Caps	_____	_____	_____	_____	_____	_____	_____	_____	_____	_____	_____	_____	_____	_____	_____
Base Frame	_____	_____	_____	_____	_____	_____	_____	_____	_____	_____	_____	_____	_____	_____	_____
(9) Plastic Glide, Ganging*	_____	_____	_____	_____	_____	_____	_____	_____	_____	_____	_____	_____	_____	_____	_____
(S) Plastic Glide, Non-ganging*	_____	_____	_____	_____	_____	_____	_____	_____	_____	_____	_____	_____	_____	_____	_____
Enhanced Upholstery	_____	_____	_____	_____	_____	_____	_____	_____	_____	_____	_____	_____	_____	_____	_____
Seat Upholstery	_____	_____	_____	_____	_____	_____	_____	_____	_____	_____	_____	_____	_____	_____	_____
Tellure	_____	_____	_____	_____	_____	_____	_____	_____	_____	_____	_____	_____	_____	_____	_____
Back Upholstery	_____	_____	_____	_____	_____	_____	_____	_____	_____	_____	_____	_____	_____	_____	_____
Tellure	_____	_____	_____	_____	_____	_____	_____	_____	_____	_____	_____	_____	_____	_____	_____
Shell Color	_____	_____	_____	_____	_____	_____	_____	_____	_____	_____	_____	_____	_____	_____	_____
Tomato	_____	_____	_____	_____	_____	_____	_____	_____	_____	_____	_____	_____	_____	_____	_____
Trim Color	_____	_____	_____	_____	_____	_____	_____	_____	_____	_____	_____	_____	_____	_____	_____
Black	_____	_____	_____	_____	_____	_____	_____	_____	_____	_____	_____	_____	_____	_____	_____
Frame Trim Color	_____	_____	_____	_____	_____	_____	_____	_____	_____	_____	_____	_____	_____	_____	_____
Trivalent Chrome	_____	_____	_____	_____	_____	_____	_____	_____	_____	_____	_____	_____	_____	_____	_____

*Wire Stacker Chair only

Very

Wire Stacker

With Arms



SCH-44-35

Dimensions

*SH: 17.3"(440mm)
 H: 30.6"(778mm)
 D: 23.3"(591mm)
 W: 23"(584mm)
 *SW: 18.8"(476mm)
 *SD: 17.3"(439mm)
 *AH: 8.5"(216mm)
 Between Arms:
 19.2"(487mm)

* All measurements taken with the BIFMA chair measuring device.

Features

- 11 mm steel rod frame.
- Single high-strength polymer shell seat and back with an optional upholstery pad.
- Upholstered seat features 0.5"(12.7mm) foam pad.
- Upholstered back features 0.5"(12.7mm) foam pad.
- Arms: Black or Fog glass-filled polypropylene arm caps.
- Frame: Available painted or trivalent chrome.
- High impact clear nylon glides available with or without ganging option.
- Stacks 5-high on the floor or 15-high on a cart. See page 105 for dimensions.
- Ganging option: Arm to armless, armless to armless.
- COM yardage / COL square footage:
 Fully Upholstered: 1.5/17.0
 Upholstered seat: 0.8/10.6

To Order, Specify:

1) Product number, including;

1 Seat or Seat Pad Option:

- 1 Leather
- 2 Fabric
- 3 Faux Leather
- 4 Polymer

2 Back or Back Pad Option:

- 1 Leather
- 2 Fabric
- 3 Faux Leather
- 4 Polymer

- 2) Fabric surface and color (seat).
- 3) Fabric surface and color (back).
- 4) Shell color - required for upholstered and non-upholstered.
- 5) Trim for arm caps and plastic components.
- 6) Frame trim color.

Ganging	Number 1 2	Price	Fabric Grade								Leather Grade A	Leather Grade B	
			A	B	C	D	E	F	G	H			
Polymer Shell Without Optional Upholstered Pad													
Non-Ganging	SCH- 4 4 -3S	\$329.22	N/A	N/A	N/A	N/A	N/A	N/A	N/A	N/A	N/A	N/A	N/A
Ganging Glide	SCH- 4 4 -39	341.72	N/A	N/A	N/A	N/A	N/A	N/A	N/A	N/A	N/A	N/A	N/A
Polymer Shell With Upholstered Seat Pad													
Non-Ganging	SCH- 4 -3SE	N/A	\$421.32	\$461.61	\$504.67	\$524.12	\$542.15	\$578.30	\$613.01	\$ 704.70	\$607.45	\$ 773.93	
Ganging Glide	SCH- 4 -39E	N/A	433.82	474.11	517.17	536.62	554.65	590.80	625.51	717.20	619.95	786.43	
Polymer Shell With Upholstered Seat and Back Pads													
Non-Ganging	SCH- -3SE	N/A	\$505.87	\$586.45	\$672.57	\$711.47	\$747.53	\$819.83	\$889.25	\$1072.63	\$878.13	\$1211.09	
Ganging Glide	SCH- -39E	N/A	518.37	598.95	685.07	723.97	760.03	832.33	901.75	1085.13	890.63	1223.59	

The following options require modification of the product number.

Stain repellent

To specify, add **P** to end of the product number (add \$42.45 list)

NOTE: Stain repellent is available on SCH-22 or SCH-24 models only.

For available fabrics, refer to surfaces.haworth.com.

Very

Wire Stacker

Without Arms



SCH-44-05

Dimensions

- *SH: 17.3"(440mm)
- H: 30.6"(778mm)
- D: 23.3"(591mm)
- W: 21.8"(554mm)
- *SW: 18.8"(476mm)
- *SD: 17.3"(439mm)

* All measurements taken with the BIFMA chair measuring device.

Features

- 11 mm steel rod frame.
- Single piece high-strength polymer shell seat and back with an optional upholstery pad.
- Upholstered seat features 0.5"(12.7mm) foam pad.
- Upholstered back features 0.5"(12.7mm) foam pad.
- Frame: Available painted or trivalent chrome.
- High impact clear nylon glides available with or without ganging option.
- Stacks 10-high on the floor, upholstered or non-upholstered; stacks 30-high non-upholstered on a cart; stacks 25-high upholstered on a cart. See page 105 for dimensions.
- Ganging option: Arm to armless, armless to armless.
- COM yardage / COL square footage:
Fully Upholstered: 1.5/17.0
Upholstered seat: 0.8/10.6

To Order, Specify:

1) Product number, including;

1 Seat or Seat Pad Option:

- 1 Leather
- 2 Fabric
- 3 Faux Leather
- 4 Polymer

2 Back or Back Pad Option:

- 1 Leather
- 2 Fabric
- 3 Faux Leather
- 4 Polymer

- 2) Fabric surface and color (seat).
- 3) Fabric surface and color (back).
- 4) Shell color - required for upholstered and non-upholstered.
- 5) Frame trim color.

Ganging	Number 1 2	Price	Fabric Grade		C	D	E	F	G	H	Leather Grade A	Leather Grade B
			A	B								
Polymer Shell Without Optional Upholstered Pad												
Non-Ganging	SCH- 4 4 -05	\$256.99	N/A	N/A	N/A	N/A	N/A	N/A	N/A	N/A	N/A	N/A
Ganging Glide	SCH- 4 4 -09	269.49	N/A	N/A	N/A	N/A	N/A	N/A	N/A	N/A	N/A	N/A
Polymer Shell With Upholstered Seat Pad												
Non-Ganging	SCH- 4 -05E	N/A	\$349.09	\$389.38	\$432.44	\$451.89	\$469.92	\$506.07	\$540.78	\$ 632.47	\$535.22	\$ 701.70
Ganging Glide	SCH- 4 -09E	N/A	361.59	401.88	444.94	464.39	482.42	518.57	553.28	644.97	547.72	714.20
Polymer Shell With Upholstered Seat and Back Pads												
Non-Ganging	SCH- -05E	N/A	\$433.64	\$514.22	\$600.34	\$639.24	\$675.30	\$747.60	\$817.02	\$1000.40	\$805.90	\$1138.86
Ganging Glide	SCH- -09E	N/A	446.14	526.72	612.84	651.74	687.80	760.10	829.52	1012.90	818.40	1151.36

The following options require modification of the product number.

Stain repellent

To specify, add **P** to end of the product number (add **\$42.45** list)

NOTE: Stain repellent is available on SCH-22 or SCH-24 models only.

For available fabrics, refer to surfaces.haworth.com.

Very

Bar Height Wire Stool

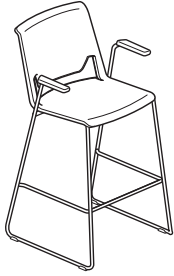

SCW-44-3S

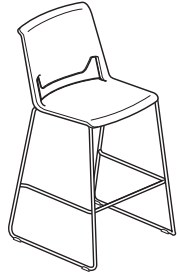

SCW-44-0S

Dimensions

SH: 29.75"(756mm)
 H: 43"(1092mm)
 D: 23"(587mm)
 W: 23"(587mm)
 SW: 18.68"(475mm)
 SD: 17.3"(439mm)
 AH: 8.5"(216mm)
 Between Arms:
 19.2"(488mm)

Features

- 11 mm steel rod frame.
- Single piece high-strength polymer shell seat and back with an optional upholstery pad.
- 10 shell color options.
- Upholstered seat features 0.5"(12.7mm) foam pad.
- Upholstered back features 0.5"(12.7mm) foam pad.
- Arms: Black or Fog glass-filled polypropylene arm caps.
- Base: trivalent chrome.
- High impact clear nylon glides.
- Stacks 5-high on the floor.
- The foot rest is 11.84"(300.7mm) from the floor.
- COM yardage / COL square footage:
 Fully Upholstered: 1.5/12.5
 Upholstered seat: .8/7.5

To Order, Specify:

1) Product number.

1 Seat or Seat Pad Option:

- 1 Leather
- 2 Fabric
- 3 Faux Leather
- 4 Polymer

2 Back or Back Pad Option:

- 1 Leather
- 2 Fabric
- 3 Faux Leather
- 4 Polymer

- 2) Fabric surface and color (seat).
- 3) Fabric surface and color (back).
- 4) Shell color - required for upholstered and non-upholstered.
- 5) Trim for arm caps (if specified).
- 6) Frame trim color (KR-V only).

Description	Number 1 2	Price	Fabric Grade								Leather Grade A	Leather Grade B	
			A	B	C	D	E	F	G	H			
Polymer Shell Without Optional Upholstered Pad													
With Arms	SCW- 44 -3S	\$558.41	N/A	N/A	N/A	N/A	N/A	N/A	N/A	N/A	N/A	N/A	N/A
Without Arms	SCW- 44 -0S	486.18	N/A	N/A	N/A	N/A	N/A	N/A	N/A	N/A	N/A	N/A	N/A
Polymer Shell With Upholstered Seat Pad													
With Arms	SCW- 4 -3SE	N/A	\$650.51	\$690.80	\$733.86	\$753.31	\$771.34	\$ 807.49	\$ 842.20	\$ 933.89	\$ 836.64	\$1003.12	
Without Arms	SCW- 4 -0SE	N/A	578.28	618.57	661.63	681.08	699.11	735.26	769.97	861.66	764.41	930.89	
Polymer Shell With Upholstered Seat and Back Pads													
With Arms	SCW- 4 -3SE	N/A	\$735.06	\$815.64	\$901.76	\$940.66	\$976.72	\$1049.02	\$1118.44	\$1301.82	\$1107.32	\$1440.28	
Without Arms	SCW- 4 -0SE	N/A	662.83	743.41	829.53	868.43	904.49	976.79	1046.21	1229.59	1035.09	1368.05	

The following options require modification of the product number.

Stain repellent

To specify, add **P** to end of the product number (add **\$42.45** list)

NOTE: Stain repellent is available on SCW-22 or SCW-24 models only.

For available fabrics, refer to surfaces.haworth.com.

Very

Counter Height Wire Stool

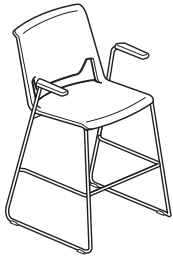

SCWC-44-3S

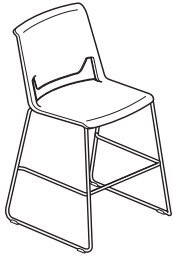

SCWC-44-0S

Dimensions

SH: 25.75"(654mm)
 H: 39"(991mm)
 D: 23"(587mm)
 W: 23"(587mm)
 SW: 18.68"(475mm)
 SD: 17.3"(439mm)
 AH: 8.5"(216mm)
 Between Arms:
 19.2"(488mm)

Features

- 11 mm steel rod frame.
- Single piece high-strength polymer shell seat and back with an optional upholstery pad.
- 10 shell color options.
- Upholstered seat features 0.5"(12.7mm) foam pad.
- Upholstered back features 0.5"(12.7mm) foam pad.
- Arms: Black or Fog glass-filled polypropylene arm caps.
- Base: trivalent chrome.
- High impact clear nylon glides.
- Stacks 5-high on the floor.
- The foot rest is 7.84"(199.1mm) from the floor.
- COM yardage / COL square footage:
 Fully Upholstered: 1.5/12.5
 Upholstered seat: .8/7.5

To Order, Specify:

1) Product number.

1 Seat or Seat Pad Option:

- 1 Leather
- 2 Fabric
- 3 Faux Leather
- 4 Polymer

2 Back or Back Pad Option:

- 1 Leather
- 2 Fabric
- 3 Faux Leather
- 4 Polymer

- 2) Fabric surface and color (seat).
- 3) Fabric surface and color (back).
- 4) Shell color - required for upholstered and non-upholstered.
- 5) Trim for arm caps (if specified).
- 6) Frame trim color (KR-V only).

Description	Number 1 2	Price	Fabric Grade								Leather Grade A	Leather Grade B	
			A	B	C	D	E	F	G	H			
Polymer Shell Without Optional Upholstered Pad													
With Arms	SCWC- 44 -3S	\$558.41	N/A	N/A	N/A	N/A	N/A	N/A	N/A	N/A	N/A	N/A	N/A
Without Arms	SCWC- 44 -0S	486.18	N/A	N/A	N/A	N/A	N/A	N/A	N/A	N/A	N/A	N/A	N/A
Polymer Shell With Upholstered Seat Pad													
With Arms	SCWC- 4 -3SE	N/A	\$650.51	\$690.80	\$733.86	\$753.31	\$771.34	\$ 807.49	\$ 842.20	\$ 933.89	\$ 836.64	\$1003.12	
Without Arms	SCWC- 4 -0SE	N/A	578.28	618.57	661.63	681.08	699.11	735.26	769.97	861.66	764.41	930.89	
Polymer Shell With Upholstered Seat and Back Pads													
With Arms	SCWC- 4 -3SE	N/A	\$735.06	\$815.64	\$901.76	\$940.66	\$976.72	\$1049.02	\$1118.44	\$1301.82	\$1107.32	\$1440.28	
Without Arms	SCWC- 4 -0SE	N/A	662.83	743.41	829.53	868.43	904.49	976.79	1046.21	1229.59	1035.09	1368.05	

The following options require modification of the product number.

Stain repellent

To specify, add **P** to end of the product number (add \$42.45 list)

NOTE: Stain repellent is available on SCWC-22 or SCWC-24 models only.

For available fabrics, refer to surfaces.haworth.com.

Very Perforated Side, Seminar and Side Stool

General Specifications

Features and Options

(Side, Seminar and Side Chair)

Side and Seminar Chair

- Back: High-strength polymer back with perforations for added flexibility and an optional upholstered foam pad
- Seat: High-strength polymer seat with an optional upholstered foam pad
- Casters: Hard (black), soft (black) or two-tone (fog and gray)
- Glides: Plastic or felt
- Frame finishes include: painted or trivalent chrome
- Weight assisted recline mechanism (Seminar model only)
- Fog or black trim arm caps and glides available
- Arm or armless version available
- Optional Laminate Tablet arm
- Optional Storage rack
- Stacking cart (8-high capacity)
- Stacks 5-high on the floor or 8-high (arms - 69" high x 46" wide x 24" deep), (armless - 57" high x 44" wide x 24" deep) on cart.
- 22mm 14-gauge steel leg tube
- Seminar Chair with intuitive reclining back.

Side Stool

- Back: High-strength polymer back with perforations for added flexibility and an optional upholstered foam pad
- Seat: High-strength polymer seat with an optional upholstered polyurethane foam pad
- Glides: Plastic or felt
- Frame finishes include: painted or trivalent chrome
- Fog or black trim arm caps and glides available
- Arm or armless version available
- Stacks 5-high on the floor

General Guidelines for Product Specification

	S	C	M	-	2	2	-	3	1	E	3A-18	3A-18	TR-FA	TR-F	TR-LE
Product Type	_____	_____	_____	_____	_____	_____	_____	_____	_____	_____	_____	_____	_____	_____	_____
(S) Seating	_____	_____	_____	_____	_____	_____	_____	_____	_____	_____	_____	_____	_____	_____	_____
Product Line	_____	_____	_____	_____	_____	_____	_____	_____	_____	_____	_____	_____	_____	_____	_____
(C) Very	_____	_____	_____	_____	_____	_____	_____	_____	_____	_____	_____	_____	_____	_____	_____
Model	_____	_____	_____	_____	_____	_____	_____	_____	_____	_____	_____	_____	_____	_____	_____
(M) Seminar	_____	_____	_____	_____	_____	_____	_____	_____	_____	_____	_____	_____	_____	_____	_____
(S) Side	_____	_____	_____	_____	_____	_____	_____	_____	_____	_____	_____	_____	_____	_____	_____
(L) Side Stool	_____	_____	_____	_____	_____	_____	_____	_____	_____	_____	_____	_____	_____	_____	_____
Seat Upholstery	_____	_____	_____	_____	_____	_____	_____	_____	_____	_____	_____	_____	_____	_____	_____
(1) Leather	_____	_____	_____	_____	_____	_____	_____	_____	_____	_____	_____	_____	_____	_____	_____
(2) Fabric	_____	_____	_____	_____	_____	_____	_____	_____	_____	_____	_____	_____	_____	_____	_____
(3) Faux Leather	_____	_____	_____	_____	_____	_____	_____	_____	_____	_____	_____	_____	_____	_____	_____
(4) Polymer	_____	_____	_____	_____	_____	_____	_____	_____	_____	_____	_____	_____	_____	_____	_____
Back Upholstery	_____	_____	_____	_____	_____	_____	_____	_____	_____	_____	_____	_____	_____	_____	_____
(1) Leather	_____	_____	_____	_____	_____	_____	_____	_____	_____	_____	_____	_____	_____	_____	_____
(2) Fabric	_____	_____	_____	_____	_____	_____	_____	_____	_____	_____	_____	_____	_____	_____	_____
(3) Faux Leather	_____	_____	_____	_____	_____	_____	_____	_____	_____	_____	_____	_____	_____	_____	_____
(4) Polymer	_____	_____	_____	_____	_____	_____	_____	_____	_____	_____	_____	_____	_____	_____	_____
Arm/Caps	_____	_____	_____	_____	_____	_____	_____	_____	_____	_____	_____	_____	_____	_____	_____
(0) No Arms	_____	_____	_____	_____	_____	_____	_____	_____	_____	_____	_____	_____	_____	_____	_____
(3) Fixed Arms, Hard Caps	_____	_____	_____	_____	_____	_____	_____	_____	_____	_____	_____	_____	_____	_____	_____
Base/Caster	_____	_____	_____	_____	_____	_____	_____	_____	_____	_____	_____	_____	_____	_____	_____
(H) 4-Leg, Plastic Glides	_____	_____	_____	_____	_____	_____	_____	_____	_____	_____	_____	_____	_____	_____	_____
(K) 4-Leg, Felt Glides	_____	_____	_____	_____	_____	_____	_____	_____	_____	_____	_____	_____	_____	_____	_____
(1) 4-Leg, Hard Casters*	_____	_____	_____	_____	_____	_____	_____	_____	_____	_____	_____	_____	_____	_____	_____
(2) 4-Leg, Soft Casters*	_____	_____	_____	_____	_____	_____	_____	_____	_____	_____	_____	_____	_____	_____	_____
(T) 4-Leg, Two-Tone Casters*	_____	_____	_____	_____	_____	_____	_____	_____	_____	_____	_____	_____	_____	_____	_____
Enhanced Upholstery	_____	_____	_____	_____	_____	_____	_____	_____	_____	_____	_____	_____	_____	_____	_____
Seat Upholstery	_____	_____	_____	_____	_____	_____	_____	_____	_____	_____	_____	_____	_____	_____	_____
Tellure	_____	_____	_____	_____	_____	_____	_____	_____	_____	_____	_____	_____	_____	_____	_____
Back Upholstery	_____	_____	_____	_____	_____	_____	_____	_____	_____	_____	_____	_____	_____	_____	_____
Tellure	_____	_____	_____	_____	_____	_____	_____	_____	_____	_____	_____	_____	_____	_____	_____
Shell Color	_____	_____	_____	_____	_____	_____	_____	_____	_____	_____	_____	_____	_____	_____	_____
Tomato	_____	_____	_____	_____	_____	_____	_____	_____	_____	_____	_____	_____	_____	_____	_____
Trim Color	_____	_____	_____	_____	_____	_____	_____	_____	_____	_____	_____	_____	_____	_____	_____
Black	_____	_____	_____	_____	_____	_____	_____	_____	_____	_____	_____	_____	_____	_____	_____
Frame Trim Color	_____	_____	_____	_____	_____	_____	_____	_____	_____	_____	_____	_____	_____	_____	_____
Metallic Silver	_____	_____	_____	_____	_____	_____	_____	_____	_____	_____	_____	_____	_____	_____	_____

*Side and Seminar chairs only.

Very

Side Chair – Perforated Back

With Arms

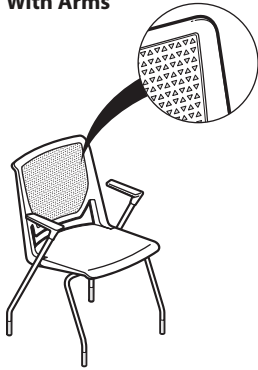

SCS-44-3H

Dimensions

- *SH: 18.2”(461mm)
- H: 33.9”(861mm)
- D: 22”(559mm)
- W: 23.5”(597mm)
- *SW: 19.2”(487mm)
- *SD: 17.5”(443mm)
- *AH: 8.9”(226mm)
- Between Arms:
19.6”(498mm)

* All measurements taken with the BIFMA chair measuring device.

Features

- Back: High-strength polymer back with flexing perforations and an optional upholstered foam pad.
- Seat: High-strength polymer seat with an optional upholstery pad.
- Upholstered seat features 1”(25.4mm) foam pad.
- Upholstered back features 0.5”(12.7mm) foam pad.
- Arms: Black or Fog glass-filled polypropylene arm caps.
- Frame: Available painted or trivalent chrome.
- Casters: Hard (black), soft (black) or two-tone (fog and gray).
- Glides: Plastic or felt.
- Stacks 5-high on the floor and 8-high on a cart with glides and casters.
- COM yardage / COL square footage:
Fully Upholstered: 1.5/17.0
Upholstered seat: 0.75/9.5

To Order, Specify:

1) Product number, including;

1 Seat or Seat Pad Option:

- 1 Leather
- 2 Fabric
- 3 Faux Leather
- 4 Polymer

2 Back or Back Pad Option:

- 1 Leather
- 2 Fabric
- 3 Faux Leather
- 4 Polymer

3 Glide or Caster Option:

- H Plastic Glide
- K Felt Glide
- 1 Hard Casters, add \$49.30 list
- 2 Soft Casters, add \$94.19 list
- T Two-Tone Casters, add \$49.30 list

- 2) Fabric surface and color (seat).
- 3) Fabric surface and color (back).
- 4) Shell color – required for upholstered and non-upholstered.
- 5) Trim for arm caps, glides and plastic components.
- 6) Frame trim color.
Trivalent Chrome (KR-V) add \$212.23 list.

Number ① ② ③	Price	Fabric Grade		C	D	E	F	G	H	Leather Grade A	Leather Grade B	
		A	B									
Without Optional Upholstered Pad												
SCS- 4 4 -3	\$380.64	N/A	N/A	N/A	N/A	N/A	N/A	N/A	N/A	N/A	N/A	
With Upholstered Seat Pad												
SCS- 4 -3 E	N/A	\$472.32	\$512.03	\$554.48	\$573.65	\$591.43	\$627.05	\$661.27	\$ 751.66	\$655.79	\$ 819.89	
With Upholstered Seat and Back Pads												
SCS- -3 E	N/A	\$557.78	\$637.20	\$722.10	\$760.44	\$796.00	\$867.24	\$935.68	\$1116.46	\$924.72	\$1252.92	

The following options require modification of the product number.

Stain repellent

To specify, add **P** to end of the product number (add \$42.45 list)

NOTE: Stain repellent is available on SCS-22 and SCS-24 models only.

For available fabrics, refer to surfaces.haworth.com.

Very

Side Chair – Perforated Back

Without Arms

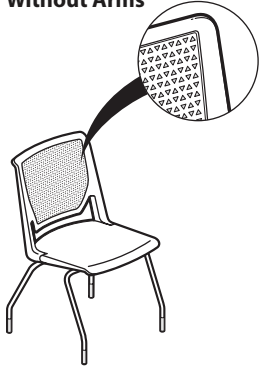

SCS-44-0H

Dimensions

- *SH: 18.2"(461mm)
- H: 33.9"(861mm)
- D: 22"(559mm)
- W: 22.3"(566mm)
- *SW: 19.2"(487mm)
- *SD: 17.5"(443mm)

* All measurements taken with the BIFMA chair measuring device.

Features

- Back: High-strength polymer back with flexing perforations and an optional upholstered foam pad.
- Seat: High-strength polymer seat with an optional upholstery pad.
- Upholstered seat features 1"(25.4mm) foam pad.
- Upholstered back features 0.5"(12.7mm) foam pad.
- Frame: Available painted or trivalent chrome.
- Casters: Hard (black), soft (black) or two-tone (fog and gray).
- Glides: Plastic or felt.
- Stacks 5-high on the floor and 8-high on a cart with glides and casters.
- COM yardage / COL square footage:
Fully Upholstered: 1.5/17
Upholstered seat: 0.75/9.5

To Order, Specify:

1) Product number, including;

1 Seat or Seat Pad Option:

- 1 Leather
- 2 Fabric
- 3 Faux Leather
- 4 Polymer

2 Back or Back Pad Option:

- 1 Leather
- 2 Fabric
- 3 Faux Leather
- 4 Polymer

3 Glide or Caster Option:

- H Plastic Glide
- K Felt Glide
- 1 Hard Casters, add \$49.30 list
- 2 Soft Casters, add \$94.19 list
- T Two-Tone Casters, add \$49.30 list

- 2) Fabric surface and color (seat).
- 3) Fabric surface and color (back).
- 4) Shell color – required for upholstered and non-upholstered.
- 5) Add glide and plastic component trim color.
- 6) Frame trim color.
Trivalent Chrome (KR-V) add \$212.23 list.

Number ① ② ③	Price	Fabric Grade		C	D	E	F	G	H	Leather Grade A	Leather Grade B
		A	B								
Without Optional Upholstered Pad											
SCS- 4 4 -0	\$309.44	N/A	N/A	N/A	N/A	N/A	N/A	N/A	N/A	N/A	N/A
With Upholstered Seat Pad											
SCS- 4 -0 E	N/A	\$401.12	\$440.83	\$483.28	\$502.45	\$520.23	\$555.85	\$590.07	\$ 680.46	\$584.59	\$ 748.69
With Upholstered Seat and Back Pads											
SCS- -0 E	N/A	\$486.58	\$566.00	\$650.90	\$689.24	\$724.80	\$796.04	\$864.48	\$1045.26	\$853.52	\$1181.72

The following options require modification of the product number.

Stain repellent

To specify, add **P** to end of the product number (add \$42.45 list)

NOTE: Stain repellent is available on SCS-22 and SCS-24 models only.

For available fabrics, refer to surfaces.haworth.com.

Side Chair With Tablet Arm



SCS-44-RH

Dimensions

- *SH: 18.2”(461mm)
- H: 33.9”(861mm)
- D: 22”(559mm)
- W: 23.5”(597mm)
- *SW: 19.2”(487mm)
- *SD: 17.5”(443mm)

* All measurements taken with the BIFMA chair measuring device.

Features

- Back: High-strength polymer back with flexing perforations and an optional upholstery pad.
- Seat: High-strength polymer with an optional upholstery pad.
- Upholstered seat features 1”(25.4mm) foam pad.
- Upholstered back features 0.5”(12.7mm) foam pad.
- Arm cap: Black.
- Tablet assembly painted black.
- Clearance from tablet to chair back 12.5”(318mm)-15.5”(394mm) angled.
- Flips up and fold away laminate tablet with matching laminate underside.
- Left or right-hand configurations.
- Tablet arm size: 15”(381mm)W x 9.8”(249mm)D (Sized to accommodate laptops).
- Base: available painted or optional trivalent chrome.
- Glides or Casters.
- Standard with hard casters, black or two-tone.
- Optional black soft casters.
- COM yardage / COL square footage:
Fully Upholstered: 1.5/13
Upholstered seat: .75/7.25

To Order, Specify:

1) Product number.

1 Seat or Seat Pad Option:

- 1 Leather
- 2 Fabric
- 3 Faux Leather
- 4 Polymer

2 Back or Back Pad Option:

- 1 Leather
- 2 Fabric
- 3 Faux Leather
- 4 Perforated Polymer

3 Tablet Option:

- R Right-Hand Tablet Arm
- L Left-Hand Tablet Arm

4 Glide or Caster Option:

- H Plastic Glide
- K Felt Glide
- 1 Hard Casters, add **\$49.30** list
- 2 Soft Casters, add **\$94.19** list
- T Two-Tone Casters, add **\$49.30** list

- 2) Fabric surface and color (seat).
- 3) Fabric surface and color (back).
- 4) Shell color - required for upholstered and non-upholstered.
- 5) Trim for arm caps (if specified) and glides.
- 6) Frame trim color.
Trivalent Chrome (KR-V) add **\$212.23** list.
- 7) Laminate for tablet (if specified).

Description	Number 1 2 3 4	Price	Fabric Grade								Leather Grade A	Leather Grade B	
			A	B	C	D	E	F	G	H			
Without Optional Upholstered Pad													
	SCS- 4 4 - ■ ■	\$549.05	N/A	N/A	N/A	N/A	N/A	N/A	N/A	N/A	N/A	N/A	N/A
With Upholstered Seat Pad													
	SCS- ■ 4 - ■ ■ E	N/A	\$640.73	\$680.44	\$722.89	\$742.06	\$759.84	\$ 795.46	\$ 829.68	\$ 920.07	\$ 824.20	\$ 988.30	
With Upholstered Seat and Back Pads													
	SCS- ■ ■ - ■ ■ E	N/A	\$726.19	\$805.61	\$890.51	\$928.85	\$964.41	\$1000.03	\$1104.09	\$1284.87	\$1093.13	\$1421.33	

The following options require modification of the product number.

Stain repellent

To specify, add **P** to end of the product number; **Example:** SCS-22-RHEP (add **\$42.45** list)

Very

Side Chair with Storage Rack – Perforated Back



SCK-44-3H

Dimensions

*SH: 18.2"(461mm)
 H: 33.9"(861mm)
 D: 22"(559mm)
 W: 23.5"(597mm)
 *SW: 19.2"(487mm)
 *SD: 17.5"(443mm)
 *AH: 8.9"(226mm)
 Between Arms:
 19.6"(498mm)

* All measurements taken with the BIFMA chair measuring device.

Features

- Back: High-strength polymer back with flexing perforations and an optional upholstery pad.
- Seat: Injection-molded with an optional upholstery pad.
- Upholstered seat features 1"(25.4mm) foam pad.
- Upholstered back features 0.5"(12.7mm) foam pad.
- Storage rack ships unassembled (chrome only).
- Arms: Black or Fog arm caps when no tablet is specified.
- Optional Tablet arm:
 - Tablet assembly painted black.
 - Flips up and fold away laminate tablet with matching laminate underside.
 - Left or right-hand configurations.
 - Tablet arm size: 15"(381mm)W x 9.8"(249mm)D (Sized to accommodate laptops).
- Base: available painted or optional trivalent chrome.
- Glides or Casters: Standard with hard casters, black or two-tone.
- Optional black soft casters.
- COM yardage / COL square footage:
 - Fully Upholstered: 1.5/13
 - Upholstered seat: .75/7.25

To Order, Specify:

1) Product number.

1 Seat or Seat Pad Option:

- 1** Leather
- 2** Fabric
- 3** Faux Leather
- 4** Polymer

2 Back or Back Pad Option:

- 1** Leather
- 2** Fabric
- 3** Faux Leather
- 4** Perforated Polymer

3 Arm Option:

- R** Right-Hand Tablet Arm, add **\$231.51** list
- L** Left-Hand Tablet Arm, add **\$231.51** list
- 0** No Arms
- 3** Fixed Arm, Hard Caps, add **\$68.79** list

4 Glide or Caster Option:

- H** Plastic Glide
- K** Felt Glide
- 1** Hard Casters, add **\$49.30** list
- 2** Soft Casters, add **\$94.19** list
- T** Two-Tone Casters, add **\$49.30** list

2) Fabric surface and color (seat).

3) Fabric surface and color (back).

4) Shell color - required for upholstered and non-upholstered.

5) Trim for arm caps (if specified) and glides.

6) Frame trim color.

Trivalent Chrome (KR-V) add **\$212.23** list.

7) Laminate for tablet (if specified).

Description	Number				Price	Fabric Grade							Leather Grade A	Leather Grade B	
	1	2	3	4		A	B	C	D	E	F	G			H
Without Optional Upholstered Pad															
SCK- 4 4 - ■ ■					\$398.43	N/A	N/A	N/A	N/A	N/A	N/A	N/A	N/A	N/A	
With Upholstered Seat Pad															
SCK- ■ 4 - ■ ■ E					N/A	\$490.11	\$529.82	\$572.27	\$591.44	\$609.22	\$644.84	\$679.06	\$ 769.45	\$ 837.68	
With Upholstered Seat and Back Pads															
SCK- ■ ■ - ■ ■ E					N/A	\$575.57	\$654.99	\$739.89	\$778.23	\$813.79	\$885.03	\$953.47	\$1134.25	\$942.51	\$1270.71

The following options require modification of the product number.

Stain repellent

To specify, add **P** to end of the product number; **Example:** SCK-22-RHEP (add **\$42.45** list)

Very

Bar Height Side Stool – Perforated Back

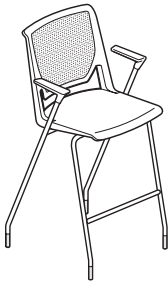

SCL-44-3H

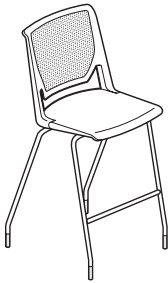

SCL-44-0H

Dimensions

- SH: 29.75"(756mm)
- H: 46.25"(1175mm)
- D: 23"(587mm)
- W: 23.75"(604mm)
- SW: 18.75"(477mm)
- SD: 17.2"(434mm)
- AH: 8.9"(226mm)
- Between Arms: 19.6"(498mm)

Features

- Back options: High-strength polymer with flexing perforations and an optional upholstery pad.
- Seat: Injection-molded high-strength polymer seat with an optional upholstery pad.
- Upholstered seat features 1"(25.4mm) foam pad.
- Upholstered back features 0.5"(12.7mm) foam pad.
- Arms: Black or Fog high-strength polymer arm caps.
- Base: available painted or optional trivalent chrome.
- Standard with glides.
- Stacks 5 high on the floor.
- COM yardage / COL square footage:
Fully Upholstered: 1.5/13
Upholstered seat: .75/7.25

To Order, Specify:

1) Product number.

1 Seat or Seat Pad Option:

- 1 Leather
- 2 Fabric
- 3 Faux Leather
- 4 Polymer

2 Back or Back Pad Option:

- 1 Leather
- 2 Fabric
- 3 Faux Leather
- 4 Perforated Polymer

3 Glide Option:

- H Plastic Glide
- K Felt Glide

- 2) Fabric surface and color (seat).
 - 3) Fabric surface and color (back).
 - 4) Shell color - required for upholstered and non-upholstered.
 - 5) Trim for arm caps (if specified) and glides.
 - 6) Frame trim color.
- Trivalent Chrome (KR-V) add \$212.23 list.

Description	Number ① ② ③	Price	Fabric Grade		C	D	E	F	G	H	Leather Grade A	Leather Grade B
			A	B								
Without Optional Upholstered Pad												
With Arms	SCL- 44 -3	\$790.04	N/A	N/A	N/A	N/A	N/A	N/A	N/A	N/A	N/A	N/A
Without Arms	SCL- 44 -0	718.84	N/A	N/A	N/A	N/A	N/A	N/A	N/A	N/A	N/A	N/A
With Upholstered Seat Pad												
With Arms	SCL- 4 -3 E	N/A	\$881.72	\$ 921.43	\$ 963.88	\$ 983.05	\$1000.83	\$1036.45	\$1070.67	\$1161.06	\$1065.19	\$1229.29
Without Arms	SCL- 4 -0 E	N/A	810.52	850.23	892.68	911.85	929.63	965.25	999.47	1089.86	993.99	1158.09
With Upholstered Seat and Back Pads												
With Arms	SCL- -3 E	N/A	\$967.18	\$1046.60	\$1131.50	\$1169.84	\$1205.40	\$1276.64	\$1345.08	\$1525.86	\$1334.12	\$1662.32
Without Arms	SCL- -0 E	N/A	895.98	975.40	1060.30	1098.64	1134.20	1205.44	1273.88	1454.66	1262.92	1591.12

The following options require modification of the product number.

Stain repellent

To specify, add **P** to end of the product number; **Example:** SCL-22-3HEP (add \$42.45 list)

NOTE: Stain repellent is available on SCL-22 or SCL-24 models only.

For available fabrics, refer to surfaces.haworth.com.

Very

Counter Height Side Stool – Perforated Back

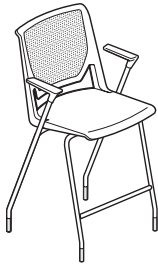

SCLC-44-3H

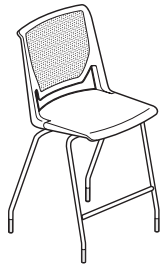

SCLC-44-0H

Dimensions

SH: 25.75"(654mm)
 H: 42.25"(1073mm)
 D: 21.7"(551mm)
 W: 23.75"(604mm)
 SW: 18.75"(477mm)
 SD: 17.2"(434mm)
 AH: 8.9"(226mm)
 Between Arms:
 19.6"(498mm)

Features

- Back options: High-strength polymer with flexing perforations and an optional upholstery pad.
- Seat: Injection-molded high-strength polymer seat with an optional upholstery pad.
- Upholstered seat features 1"(25.4mm) foam pad.
- Upholstered back features 0.5"(12.7mm) foam pad.
- Arms: Black or Fog high-strength polymer arm caps.
- Base: available painted or optional trivalent chrome.
- Standard with glides.
- Stacks 5 high on the floor.
- COM yardage / COL square footage:
 Fully Upholstered: 1.5/13
 Upholstered seat: .75/7.25

To Order, Specify:

1) Product number.

1 Seat or Seat Pad Option:

- 1 Leather
- 2 Fabric
- 3 Faux Leather
- 4 Polymer

2 Back or Back Pad Option:

- 1 Leather
- 2 Fabric
- 3 Faux Leather
- 4 Perforated Polymer

3 Glide Option:

- H Plastic Glide
- K Felt Glide

2) Fabric surface and color (seat).

3) Fabric surface and color (back).

4) Shell color - required for upholstered and non-upholstered.

5) Trim for arm caps (if specified) and glides.

6) Frame trim color.

Trivalent Chrome (KR-V) add \$212.23 list.

Description	Number			Price	Fabric Grade								Leather Grade A	Leather Grade B
	1	2	3		A	B	C	D	E	F	G	H		
Without Optional Upholstered Pad														
With Arms	SCLC-	44	-3	\$790.04	N/A	N/A	N/A	N/A	N/A	N/A	N/A	N/A	N/A	N/A
Without Arms	SCLC-	44	-0	718.84	N/A	N/A	N/A	N/A	N/A	N/A	N/A	N/A	N/A	N/A
With Upholstered Seat Pad														
With Arms	SCLC-	4	-3	N/A	\$881.72	\$ 921.43	\$ 963.88	\$ 983.05	\$1000.83	\$1036.45	\$1070.67	\$1161.06	\$1065.19	\$1229.29
Without Arms	SCLC-	4	-0	N/A	810.52	850.23	892.68	911.85	929.63	965.25	999.47	1089.86	993.99	1158.09
With Upholstered Seat and Back Pads														
With Arms	SCLC-		-3	N/A	\$967.18	\$1046.60	\$1131.50	\$1169.84	\$1205.40	\$1276.64	\$1345.08	\$1525.86	\$1334.12	\$1662.32
Without Arms	SCLC-		-0	N/A	895.98	975.40	1060.30	1098.64	1134.20	1205.44	1273.88	1454.66	1262.92	1591.12

The following options require modification of the product number.

Stain repellent

To specify, add **P** to end of the product number; **Example:** SCLC-22-3HEP (add \$42.45 list)

NOTE: Stain repellent is available on SCLC-22 or SCLC-24 models only.

For available fabrics, refer to surfaces.haworth.com.

Very

Seminar Chair – Perforated Back

With Arms

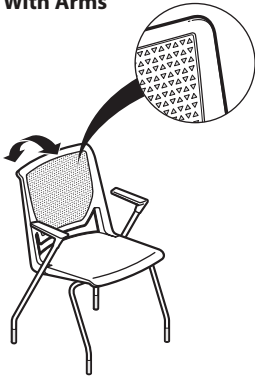

SCM-44-3H

Dimensions

- *SH: 18.2”(461mm)
- H: 33.9”(861mm)
- D: 22”(559mm)
- W: 23.5”(597mm)
- *SW: 19.2”(487mm)
- *SD: 17.5”(443mm)
- *AH: 8.9”(226mm)
- Between Arms:
19.6”(498mm)

* All measurements taken with the BIFMA chair measuring device.

Features

- Back: High-strength polymer back with flexing perforations and an optional upholstered foam pad.
- Seat: High-strength polymer seat with an optional upholstery pad.
- Weight assisted recline mechanism.
- Upholstered seat features 1”(25.4mm) foam pad.
- Upholstered back features 0.5”(12.7mm) foam pad.
- Arms: Black or Fog glass-filled polypropylene arm caps.
- Frame: Available painted or trivalent chrome.
- Casters: Hard (black), soft (black) or two-tone (fog and gray).
- Glides: Plastic or felt.
- Stacks 5-high on the floor and 8-high on a cart with glides and casters.
- COM yardage / COL square footage:
Fully Upholstered: 1.5/17
Upholstered seat: 0.75/9.5

To Order, Specify:

1) Product number, including;

1 Seat or Seat Pad Option:

- 1 Leather
- 2 Fabric
- 3 Faux Leather
- 4 Polymer

2 Back or Back Pad Option:

- 1 Leather
- 2 Fabric
- 3 Faux Leather
- 4 Polymer

3 Glide or Caster Option:

- H Plastic Glide
- K Felt Glide
- 1 Hard Casters, add **\$62.98** list
- 2 Soft Casters, add **\$107.42** list
- T Two-Tone Casters, add **\$62.98** list

- 2) Fabric surface and color (seat).
- 3) Fabric surface and color (back).
- 4) Shell color – required for upholstered and non-upholstered.
- 5) Trim for arm caps, glides, and plastic components.
- 6) Frame trim color.
Trivalent Chrome (KR-V) add **\$212.23** list.

Number 1 2 3	Price	Fabric Grade		C	D	E	F	G	H	Leather Grade A	Leather Grade B
		A	B								
Without Optional Upholstered Pad											
SCM- 4 4 -3	\$655.86	N/A	N/A	N/A	N/A	N/A	N/A	N/A	N/A	N/A	N/A
With Upholstered Seat Pad											
SCM- 4 -3 E	N/A	\$772.09	\$811.80	\$ 854.25	\$ 873.42	\$ 891.20	\$ 926.82	\$ 961.04	\$1051.43	\$ 955.56	\$1119.66
With Upholstered Seat and Back Pads											
SCM- -3 E	N/A	\$861.28	\$940.70	\$1025.60	\$1063.94	\$1099.50	\$1170.74	\$1239.18	\$1419.96	\$1228.22	\$1556.42

The following options require modification of the product number.

Stain repellent

To specify, add **P** to end of the product number (add **\$42.45** list)

NOTE: Stain repellent is available on SCM-22 and SCM-24 models only.

For available fabrics, refer to surfaces.haworth.com.

Very

Seminar Chair – Perforated Back

Without Arms

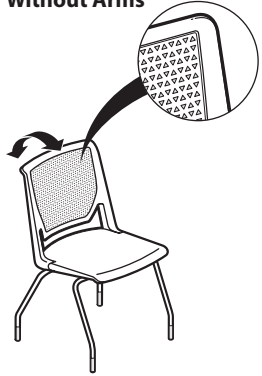

SCM-44-0H

Dimensions

- *SH: 18.2"(461mm)
- H: 33.9"(861mm)
- D: 22"(559mm)
- W: 22.3"(566mm)
- *SW: 19.2"(487mm)
- *SD: 17.5"(443mm)

* All measurements taken with the BIFMA chair measuring device.

Features

- Back: High-strength polymer back with flexing perforations and an optional upholstered foam pad.
- Seat: High-strength polymer seat with an optional upholstery pad.
- Weight assisted recline mechanism.
- Upholstered seat features 1"(25.4mm) foam pad.
- Upholstered back features 0.5"(12.7mm) foam pad.
- Arms: Black or Fog glass-filled polypropylene arm caps.
- Frame: Available painted or trivalent chrome.
- Casters: Hard (black), soft (black) or two-tone (fog and gray).
- Glides: Plastic or felt.
- Stacks 5-high on the floor and 8-high on a cart with glides and casters.
- COM yardage / COL square footage:
Fully Upholstered: 1.5/17
Upholstered seat: 0.75/9.5

To Order, Specify:

1) Product number, including;

1 Seat or Seat Pad Option:

- 1 Leather
- 2 Fabric
- 3 Faux Leather
- 4 Polymer

2 Back or Back Pad Option:

- 1 Leather
- 2 Fabric
- 3 Faux Leather
- 4 Polymer

3 Glide or Caster Option:

- H Plastic Glide
- K Felt Glide
- 1 Hard Casters, add \$62.98 list
- 2 Soft Casters, add \$107.42 list
- T Two-Tone Casters, add \$62.98 list

- 2) Fabric surface and color (seat).
 - 3) Fabric surface and color (back).
 - 4) Shell color – required for upholstered and non-upholstered.
 - 5) Glide and plastic component trim color.
 - 6) Frame trim color.
- Trivalent Chrome (KR-V) add \$212.23 list.

Number ① ② ③	Price	Fabric Grade										Leather Grade A	Leather Grade B
		A	B	C	D	E	F	G	H				
Without Optional Upholstered Pad													
SCM- 4 4 -0	\$584.66	N/A	N/A	N/A	N/A	N/A	N/A	N/A	N/A	N/A	N/A	N/A	N/A
With Upholstered Seat Pad													
SCM- 4 -0 E	N/A	\$700.89	\$740.60	\$783.05	\$802.22	\$ 820.00	\$ 855.62	\$ 889.84	\$ 980.23	\$ 884.36	\$1048.46		
With Upholstered Seat and Back Pads													
SCM- -0 E	N/A	\$790.08	\$869.50	\$954.40	\$992.74	\$1028.30	\$1099.54	\$1167.98	\$1348.76	\$1157.02	\$1485.22		

The following options require modification of the product number.

Stain repellent

To specify, add **P** to end of the product number (add \$42.45 list)

NOTE: Stain repellent is available on SCM-22 and SCM-24 models only.

For available fabrics, refer to surfaces.haworth.com.

Very

Seminar with Tablet Arm – Perforated Back

Seminar With Tablet Arm

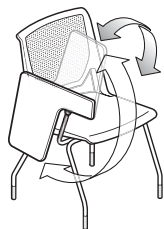

SCM-44-RH

Dimensions

- *SH: 18.2"(461mm)
- H: 33.9"(861mm)
- W: 23.5"(597mm)
- D: 22"(559mm)
- *SW: 19.2"(487mm)
- *SD: 17.5"(443mm)

* All measurements taken with the BIFMA chair measuring device.

Features

- Back: High-strength polymer back with flexing perforations and an optional upholstery pad.
- Seat: High-strength polymer with an optional upholstery pad.
- Weight assisted recline mechanism.
- Upholstered seat features 1"(25.4mm) foam pad.
- Upholstered back features 0.5"(12.7mm) foam pad.
- Arm caps: Black.
- Tablet assembly painted black.
- Clearance from tablet to chair back 12.5"(318mm)-15.5"(394mm) angled.
- Flips up and fold away laminate tablet with matching laminate underside.
- Left or right-hand configurations.
- Tablet arm size: 15"(381mm)W x 9.8"(249mm)D (Sized to accommodate laptops).
- Base: available painted or optional trivalent chrome.
- Glides or Casters.
- Standard with hard casters, black or two-tone.
- Optional black soft casters.
- COM yardage / COL square footage:
Fully Upholstered: 1.5/13
Upholstered seat: .75/7.25

To Order, Specify:

1) Product number.

1 Seat or Seat Pad Option:

- 1 Leather
- 2 Fabric
- 3 Faux Leather
- 4 Polymer

2 Back or Back Pad Option:

- 1 Leather
- 2 Fabric
- 3 Faux Leather
- 4 Perforated Polymer

3 Tablet Option:

- R Right-Hand Tablet Arm
- L Left-Hand Tablet Arm

4 Glide or Caster Option:

- H Plastic Glide
- K Felt Glide
- 1 Hard Casters, add **\$62.98** list
- 2 Soft Casters, add **\$107.42** list
- T Two-Tone Casters, add **\$62.98** list

- 2) Fabric surface and color (seat).
- 3) Fabric surface and color (back).
- 4) Shell color - required for upholstered and non-upholstered.
- 5) Trim for arm caps (if specified) and glides.
- 6) Frame trim color.
- Trivalent Chrome (KR-V) add **\$212.23** list.
- 7) Laminate for tablet (if specified).

Description	Number 1 2 3 4	Price	Fabric Grade								Leather Grade A	Leather Grade B
			A	B	C	D	E	F	G	H		
Without Optional Upholstered Pad												
SCM- 4 4 -		\$824.27	N/A	N/A	N/A	N/A	N/A	N/A	N/A	N/A	N/A	N/A
With Upholstered Seat Pad												
SCM- 4 -	E	N/A	\$ 940.50	\$ 980.21	\$1022.66	\$1041.83	\$1059.61	\$1095.23	\$1129.45	\$1219.84	\$1123.97	\$1288.07
With Upholstered Seat and Back Pads												
SCM- -	E	N/A	\$1029.69	\$1109.11	\$1194.01	\$1232.35	\$1267.91	\$1339.15	\$1407.59	\$1588.37	\$1396.63	\$1724.83

The following options require modification of the product number.

Stain repellent

To specify, add **P** to end of the product number; **Example:** SCM-22-RHEP (add **\$42.45** list)

Very

Seminar with Storage Rack – Perforated Back

Seminar With Storage Rack

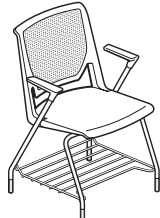

SCB-44-3H

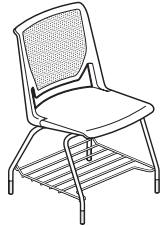

SCB-44-0H

Dimensions

- *SH: 18.2”(461mm)
- H: 33.9”(861mm)
- D: 22”(559mm)
- W: 23.5”(597mm)
- *SW: 19.2”(487mm)
- *SD: 17.5”(443mm)
- *AH: 8.9”(226mm)
- Between Arms: 19.6”(498mm)

* All measurements taken with the BIFMA chair measuring device.

Features

- Back: High-strength polymer back with flexing perforations and an optional upholstery pad.
- Seat: High-strength polymer seat with an optional upholstery pad.
- Weight assisted recline mechanism.
- Upholstered seat features 1”(25.4mm) foam pad.
- Upholstered back features 0.5”(12.7mm) foam pad.
- Arms: Black or Fog arm caps.
- Storage rack available in Chrome only.
- Tablet assembly painted black.
- Flips up and fold away laminate tablet with matching laminate underside.
- Left or right-hand configurations.
- Tablet arm size: 15”(381mm)W x 9.8”(249mm)D (Sized to accommodate laptops).
- Ships with chair, unassembled.
- Base: available painted or optional trivalent chrome.
- Glides or Casters: Standard with hard casters, black or two-tone.
- Optional black soft casters.
- COM yardage / COL square footage:
Fully Upholstered: 1.5/13
Upholstered seat: .75/7.25

To Order, Specify:

1) Product number.

1 Seat or Seat Pad Option:

- 1 Leather
- 2 Fabric
- 3 Faux Leather
- 4 Polymer Back or Back Pad

2 Back or Back Pad Option:

- 1 Leather
- 2 Fabric Faux Leather
- 4 Perforated Polymer

3 Arm Option:

- R Right-Hand Tablet Arm, add **\$231.51** list
- L Left-Hand Tablet Arm, add **\$231.51** list
- 0 No Arms
- 3 Fixed Arm, Hard Caps, add **\$68.79** list

4 Glide or Caster Option:

- H Plastic Glide
- K Felt Glide
- 1 Hard Casters, add **\$62.98** list
- 2 Soft Casters, add **\$107.42** list
- T Two-Tone Casters, add **\$62.98** list

2) Fabric surface and color (seat).

3) Fabric surface and color (back).

4) Shell color - required for upholstered and non-upholstered.

5) Trim for arm caps (if specified) and glides.

6) Frame trim color.

Trivalent Chrome (KR-V) add **\$212.23** list.

Description	Number				Price	Fabric Grade								Leather Grade A	Leather Grade B
	1	2	3	4		A	B	C	D	E	F	G	H		
Without Optional Upholstered Pad															
SCB- 4 4 -					\$673.65	N/A	N/A	N/A	N/A	N/A	N/A	N/A	N/A	N/A	
With Upholstered Seat Pad															
SCB- 4 -				E	N/A	\$789.88	\$829.59	\$ 872.04	\$ 891.21	\$ 908.99	\$ 944.61	\$ 978.83	\$1069.22	\$ 973.35	\$1137.45
With Upholstered Seat and Back Pads															
SCB- -				E	N/A	\$879.07	\$958.49	\$1043.39	\$1081.73	\$1117.29	\$1188.53	\$1256.97	\$1437.75	\$1246.01	\$1574.21

The following options require modification of the product number.

Stain repellent

To specify, add **P** to end of the product number; **Example:** SCB-22-RHEP (add **\$42.45** list)

Very Perforated Conference Chair and Conference Stool

General Specifications

**Features and Options
(Conference Chair and Conference Stool)**

- Back: High-strength polymer back with flexing perforations and an optional upholstered foam pad
- Seat: High-strength polymer seat with an optional upholstered polyurethane foam pad
- Five-star base with casters: hard (black), soft (black) or two-tone (fog and gray)
- Base: painted aluminum, polished aluminum or plastic (fog or black)
- Frame finishes include: painted or polished aluminum
- Weight assisted recline mechanism
- Pneumatic height adjustment
- Fog or black trim arm caps
- Arm or armless version available
- Adjustable footring in brushed aluminum (stool only)

**General Guidelines for
Product Specification**

	S	C	C - 2	2 - 1	1	E	3A-18	3A-18	TR-FA	TR-F	TR-LE
Conference											
Product Type	_____	_____	_____	_____	_____	_____	_____	_____	_____	_____	_____
(S) Seating	_____	_____	_____	_____	_____	_____	_____	_____	_____	_____	_____
Product Line	_____	_____	_____	_____	_____	_____	_____	_____	_____	_____	_____
(C) Very	_____	_____	_____	_____	_____	_____	_____	_____	_____	_____	_____
Model	_____	_____	_____	_____	_____	_____	_____	_____	_____	_____	_____
(C) Conference	_____	_____	_____	_____	_____	_____	_____	_____	_____	_____	_____
(F) Stool	_____	_____	_____	_____	_____	_____	_____	_____	_____	_____	_____
Seat Upholstery	_____	_____	_____	_____	_____	_____	_____	_____	_____	_____	_____
(1) Leather	_____	_____	_____	_____	_____	_____	_____	_____	_____	_____	_____
(2) Fabric	_____	_____	_____	_____	_____	_____	_____	_____	_____	_____	_____
(3) Faux Leather	_____	_____	_____	_____	_____	_____	_____	_____	_____	_____	_____
(4) Polymer	_____	_____	_____	_____	_____	_____	_____	_____	_____	_____	_____
Back Upholstery	_____	_____	_____	_____	_____	_____	_____	_____	_____	_____	_____
(1) Leather	_____	_____	_____	_____	_____	_____	_____	_____	_____	_____	_____
(2) Fabric	_____	_____	_____	_____	_____	_____	_____	_____	_____	_____	_____
(3) Faux Leather	_____	_____	_____	_____	_____	_____	_____	_____	_____	_____	_____
(4) Polymer	_____	_____	_____	_____	_____	_____	_____	_____	_____	_____	_____
Arm/Caps	_____	_____	_____	_____	_____	_____	_____	_____	_____	_____	_____
(0) No Arms	_____	_____	_____	_____	_____	_____	_____	_____	_____	_____	_____
(1) Fixed Arms, Soft Caps	_____	_____	_____	_____	_____	_____	_____	_____	_____	_____	_____
Base/Caster	_____	_____	_____	_____	_____	_____	_____	_____	_____	_____	_____
(1) Aluminum Standard Base, Hard Caster	_____	_____	_____	_____	_____	_____	_____	_____	_____	_____	_____
(2) Aluminum Standard Base, Soft Caster	_____	_____	_____	_____	_____	_____	_____	_____	_____	_____	_____
(3) Aluminum Low Base, Hard Caster	_____	_____	_____	_____	_____	_____	_____	_____	_____	_____	_____
(4) Aluminum Low Base, Soft Caster	_____	_____	_____	_____	_____	_____	_____	_____	_____	_____	_____
(5) Plastic Standard Base, Hard Caster	_____	_____	_____	_____	_____	_____	_____	_____	_____	_____	_____
(6) Plastic Standard Base, Soft Caster	_____	_____	_____	_____	_____	_____	_____	_____	_____	_____	_____
(7) Plastic Low Base, Hard Caster	_____	_____	_____	_____	_____	_____	_____	_____	_____	_____	_____
(8) Plastic Low Base, Soft Caster	_____	_____	_____	_____	_____	_____	_____	_____	_____	_____	_____
(N) Plastic Low Base, Two-Tone Casters	_____	_____	_____	_____	_____	_____	_____	_____	_____	_____	_____
(P) Plastic Standard Base, Two-Tone Casters	_____	_____	_____	_____	_____	_____	_____	_____	_____	_____	_____
(R) Aluminum Low Base, Two-Tone Casters	_____	_____	_____	_____	_____	_____	_____	_____	_____	_____	_____
(T) Aluminum Standard Base, Two-Tone Casters	_____	_____	_____	_____	_____	_____	_____	_____	_____	_____	_____
Enhanced Upholstery	_____	_____	_____	_____	_____	_____	_____	_____	_____	_____	_____
Seat Upholstery	_____	_____	_____	_____	_____	_____	_____	_____	_____	_____	_____
Tellure	_____	_____	_____	_____	_____	_____	_____	_____	_____	_____	_____
Back Upholstery	_____	_____	_____	_____	_____	_____	_____	_____	_____	_____	_____
Tellure	_____	_____	_____	_____	_____	_____	_____	_____	_____	_____	_____
Shell Color	_____	_____	_____	_____	_____	_____	_____	_____	_____	_____	_____
Tomato	_____	_____	_____	_____	_____	_____	_____	_____	_____	_____	_____
Trim Color	_____	_____	_____	_____	_____	_____	_____	_____	_____	_____	_____
Black	_____	_____	_____	_____	_____	_____	_____	_____	_____	_____	_____
Frame Trim Color	_____	_____	_____	_____	_____	_____	_____	_____	_____	_____	_____
Metallic Silver	_____	_____	_____	_____	_____	_____	_____	_____	_____	_____	_____

Very

Conference Chair - Perforated Back

With Arms



SCC-44-11

Dimensions

- *SH: 15.5"(394mm)-20.5"(521mm)
- H: 36.9"(937mm)
- D: 26.7"(678mm)
- W: 25"(635mm)
- *SW: 19.2"(487mm)
- *SD: 17.5"(443mm)
- *AH: 8.7"(220mm)
- Between Arms: 20.8"(528mm)

Low position base:

- *SH: 14.4"(366mm)-19.4"(493mm)

* All measurements taken with the BIFMA chair measuring device.

Features

- Back: High-strength polymer with flexing perforations and an optional upholstered foam pad.
- Seat: High-strength polymer with an optional upholstered foam pad.
- Upholstered seat features 1"(25.4mm) foam pad.
- Upholstered back features 0.5"(12.7mm) foam pad.
- Arms: Black or Fog glass-filled polypropylene hard arm caps.
- Base: Standard five-star all aluminum or all plastic base.
- 5"(127mm) height adjustment.
- Weight assisted recline mechanism.
- Casters: Hard (black), soft (black) or two-tone (fog and gray).
- Back tilts backward 14° from the upright position. Additional recline achieved in flexible back.
- Painted or optional polished aluminum.
- COM yardage / COL square footage:
Fully Upholstered: 1.5/17
Upholstered seat: 0.75/9.5

To Order, Specify:

1) Product number, including;

1 Seat or Seat Pad Option:

- 1 Leather
- 2 Fabric
- 3 Faux Leather
- 4 Polymer

2 Back or Back Pad Option:

- 1 Leather
- 2 Fabric
- 3 Faux Leather
- 4 Polymer

To Order, Specify (cont'd):

3 Base/Caster Option:

Aluminum Base

- 1 Aluminum Std. Base, Hard Caster
- 2 Aluminum Std. Base, Soft Caster, add **\$46.58** list
- 3 Aluminum Low Base, Hard Caster
- 4 Aluminum Low Base, Soft Caster, add **\$46.58** list

Plastic Base

- 5 Plastic Std. Base, Hard Caster
- 6 Plastic Std. Base, Soft Caster, add **\$46.58** list
- 7 Plastic Low Base, Hard Caster
- 8 Plastic Low Base, Soft Caster, add **\$46.58** list

Two-Tone Casters

- N Plastic Low Base, Two-Tone Casters
- P Plastic Std. Base, Two-Tone Casters
- R Aluminum Low Base, Two-Tone Casters
- T Aluminum Std. Base, Two-Tone Casters

- 2) Fabric surface and color (seat).
 - 3) Fabric surface and color (back).
 - 4) Shell color – required for upholstered and non-upholstered.
 - 5) Trim for arm caps, plastic components and base (plastic base only).
 - 6) Trim color for aluminum components (aluminum base, control housing, and frame).
- Polished Aluminum (PM-P) add **\$212.23** list.

Number 1 2 3	Price	Fabric Grade		C	D	E	F	G	H	Leather Grade A	Leather Grade B
		A	B								
Aluminum Base Without Optional Upholstered Pad											
SCC- 4 4 -1	\$1059.77	N/A	N/A	N/A	N/A	N/A	N/A	N/A	N/A	N/A	N/A
Aluminum Base With Upholstered Seat Pad											
SCC- 4 4 -1 E	N/A	\$1201.19	\$1240.90	\$1283.35	\$1302.52	\$1320.30	\$1355.92	\$1390.14	\$1480.53	\$1384.66	\$1548.76
Aluminum Base With Upholstered Seat and Back Pads											
SCC- 4 4 -1 E	N/A	\$1300.62	\$1380.04	\$1464.94	\$1503.28	\$1538.84	\$1610.08	\$1678.52	\$1859.30	\$1667.56	\$1995.76
Plastic Base Without Optional Upholstered Pad											
SCC- 4 4 -1	\$ 918.75	N/A	N/A	N/A	N/A	N/A	N/A	N/A	N/A	N/A	N/A
Plastic Base With Upholstered Seat Pad											
SCC- 4 4 -1 E	N/A	\$1060.17	\$1099.88	\$1142.33	\$1161.50	\$1179.28	\$1214.90	\$1249.12	\$1339.51	\$1243.64	\$1407.74
Plastic Base With Upholstered Seat and Back Pads											
SCC- 4 4 -1 E	N/A	\$1159.60	\$1239.02	\$1323.92	\$1362.26	\$1397.82	\$1469.06	\$1537.50	\$1718.28	\$1526.54	\$1854.74

The following options require modification of the product number.

Stain repellent

To specify, add **P** to end of the product number (add **\$42.45** list)

NOTE: Stain repellent is available on SCC-22 and SCC-24 models only.

For available fabrics, refer to surfaces.haworth.com.

Very

Conference Chair - Perforated Back

Without Arms

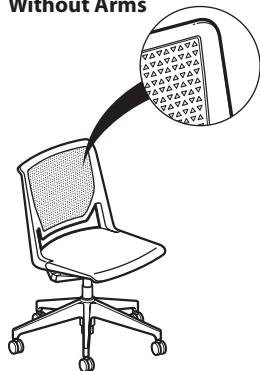

SCC-44-01

Dimensions

- *SH: 15.5"(394mm)-20.5"(521mm)
- H: 36.9"(937mm)
- D: 26.7"(678mm)
- W: 21.8"(554mm)
- *SW: 19.2"(487mm)
- *SD: 17.5"(443mm)

- Low position base:
*SH: 14.4"(366mm)-19.4"(493mm)

* All measurements taken with the BIFMA chair measuring device.

Features

- Back: High-strength polymer with flexing perforations and an optional upholstered foam pad.
- Seat: High-strength polymer with an optional upholstered foam pad.
- Upholstered seat features 1"(25.4mm) foam pad.
- Upholstered back features 0.5"(12.7mm) foam pad.
- Base: Standard five-star all aluminum or all plastic base.
- 5"(127mm) height adjustment.
- Weight assisted recline mechanism.
- Casters: Hard (black), soft (black) or two-tone (fog and gray).
- Back tilts backward 14° from the upright position. Additional recline achieved in flexible back.
- Painted or optional polished aluminum.
- COM yardage / COL square footage:
Fully Upholstered: 1.5/17
Upholstered seat: 0.75/9.5

To Order, Specify:

1) Product number, including;

1 Seat or Seat Pad Option:

- 1 Leather
- 2 Fabric
- 3 Faux Leather
- 4 Polymer

2 Back or Back Pad Option:

- 1 Leather
- 2 Fabric
- 3 Faux Leather
- 4 Polymer

To Order, Specify (cont'd):

3 Base/Caster Option:

Aluminum Base

- 1 Aluminum Std. Base, Hard Caster
- 2 Aluminum Std. Base, Soft Caster, add **\$46.58** list
- 3 Aluminum Low Base, Hard Caster
- 4 Aluminum Low Base, Soft Caster, add **\$46.58** list

Plastic Base

- 5 Plastic Std. Base, Hard Caster
- 6 Plastic Std. Base, Soft Caster, add **\$46.58** list
- 7 Plastic Low Base, Hard Caster
- 8 Plastic Low Base, Soft Caster, add **\$46.58** list

Two-Tone Casters

- N Plastic Low Base, Two-Tone Casters
- P Plastic Std. Base, Two-Tone Casters
- R Aluminum Low Base, Two-Tone Casters
- T Aluminum Std. Base, Two-Tone Casters

- 2) Fabric surface and color (seat).
 - 3) Fabric surface and color (back).
 - 4) Shell color – required for upholstered and non-upholstered.
 - 5) Trim for plastic components and base (plastic base only).
 - 6) Trim color for aluminum components (aluminum base, control housing, and frame).
- Polished Aluminum (PM-P) add **\$212.23** list.

Number 1 2 3	Price	Fabric Grade		C	D	E	F	G	H	Leather Grade A	Leather Grade B
		A	B								
Aluminum Base Without Optional Upholstered Pad											
SCC- 4 4 -0	\$974.88	N/A	N/A	N/A	N/A	N/A	N/A	N/A	N/A	N/A	N/A
Aluminum Base With Upholstered Seat Pad											
SCC- 4 4 -0 E	N/A	\$1116.30	\$1156.01	\$1198.46	\$1217.63	\$1235.41	\$1271.03	\$1305.25	\$1395.64	\$1299.77	\$1463.87
Aluminum Base With Upholstered Seat and Back Pads											
SCC- 4 4 -0 E	N/A	\$1215.73	\$1295.15	\$1380.05	\$1418.39	\$1453.95	\$1525.19	\$1593.63	\$1774.41	\$1582.67	\$1910.87
Plastic Base Without Optional Upholstered Pad											
SCC- 4 4 -0	\$833.86	N/A	N/A	N/A	N/A	N/A	N/A	N/A	N/A	N/A	N/A
Plastic Base With Upholstered Seat Pad											
SCC- 4 4 -0 E	N/A	\$ 975.28	\$1014.99	\$1057.44	\$1076.61	\$1094.39	\$1130.01	\$1164.23	\$1254.62	\$1158.75	\$1322.85
Plastic Base With Upholstered Seat and Back Pads											
SCC- 4 4 -0 E	N/A	\$1074.71	\$1154.13	\$1239.03	\$1277.37	\$1312.93	\$1384.17	\$1452.61	\$1633.39	\$1441.65	\$1769.85

The following options require modification of the product number.

Stain repellent

To specify, add **P** to end of the product number (add **\$42.45** list)

NOTE: Stain repellent is available on SCC-22 and SCC-24 models only.

For available fabrics, refer to surfaces.haworth.com.

Very

Conference Stool – Perforated Back



SCF-44-11



SCF-44-01

Dimensions

SH: 23"-32"
(584mm-813mm)
H: 44.4"-53.4"
(1128mm-1356mm)
D: 26.7"(678mm)
W: 25"(635mm)
SW: 18.75"(477mm)
SD: 17.2"(434mm)
AH: 8.7"(221mm)
Between Arms:
20.8"(528mm)

Features

- Back: High-strength polymer back with flexing perforations and an optional upholstery pad.
- Seat: High-strength polymer seat with an optional upholstery pad.
- Weight assisted recline mechanism.
- Upholstered seat features 1"(25.4mm) foam pad.
- Upholstered back features 0.5"(12.7mm) foam pad.
- Arms: Black or Fog hard arm caps.
- Base: Standard five-star all aluminum or all plastic base.
- Footring: Brushed Aluminum finish.
- Adjustable footring: adjusts 4"(102mm) up and down.
- Casters: Standard with hard casters, black or two-tone.
- Optional black soft casters.
- COM yardage / COL square footage:
Fully Upholstered: 1.5/13
Upholstered seat: .75/7.25

To Order, Specify:

1) Product number.

1 Seat or Seat Pad Option:

- 1 Leather
- 2 Fabric
- 3 Faux Leather
- 4 Polymer

2 Back or Back Pad Option:

- 1 Leather
- 2 Fabric
- 3 Faux Leather
- 4 Perforated Polymer

3 Arm Option:

- 0 No Arms
- 1 Fixed Arm, Hard Caps, add \$169.78 list

4 Base or Caster Option:

Aluminum Base

- 1 Aluminum Std. Base, Hard Casters
- 2 Aluminum Std. Base, Soft Casters, add \$46.58 list
- T Aluminum Std. Base, Two-Tone Casters

Plastic Base

- 5 Plastic Std. Base, Hard Casters
- 6 Plastic Std. Base, Soft Casters, add \$46.58 list
- P Plastic Std. Base, Two-Tone Casters

- 2) Fabric surface and color (seat).
- 3) Fabric surface and color (back).
- 4) Shell color - required for upholstered and non-upholstered.
- 5) Trim for arm caps (if specified). (base if plastic is specified above).
- 6) Frame trim color- Aluminum components (base if aluminum and arm uprights).

Description	Number				Price	Fabric Grade						Leather Grade A	Leather Grade B		
	1	2	3	4		A	B	C	D	E	F			G	H
Aluminum Base Without Optional Upholstered Pad															
SCF- 4 4 -					\$1376.07	N/A	N/A	N/A	N/A	N/A	N/A	N/A	N/A	N/A	
Aluminum Base With Upholstered Seat Pad															
SCF- 4 -			E		N/A	\$1517.49	\$1557.20	\$1599.65	\$1618.82	\$1636.60	\$1672.22	\$1706.44	\$1796.83	\$1700.96	\$1865.06
Aluminum Base With Upholstered Seat and Back Pads															
SCF- -			E		N/A	\$1616.92	\$1696.34	\$1781.24	\$1819.58	\$1855.14	\$1926.38	\$1994.82	\$2175.60	\$1983.86	\$2312.06
Plastic Base Without Optional Upholstered Pad															
SCF- 4 4 -					\$1235.05	N/A	N/A	N/A	N/A	N/A	N/A	N/A	N/A	N/A	
Plastic Base With Upholstered Seat Pad															
SCF- 4 -			E		N/A	\$1376.47	\$1416.18	\$1458.63	\$1477.80	\$1495.58	\$1531.20	\$1565.42	\$1655.81	\$1559.94	\$1724.04
Plastic Base With Upholstered Seat and Back Pads															
SCF- -			E		N/A	\$1475.90	\$1555.32	\$1640.22	\$1678.56	\$1714.12	\$1785.36	\$1853.80	\$2034.58	\$1842.84	\$2171.04

The following options require modification of the product number.

Stain repellent

To specify, add **P** to end of the product number; **Example:** SCF-22-01EP (add \$42.45 list)

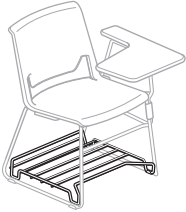
	Description	Number	Price
 <p>SCHR-1 Class VY – SIN 33721; Discount Group XVIII</p>	Storage Rack	SCHR-1	\$88.99
	<p>Features</p> <ul style="list-style-type: none"> • Chrome only. • Recommended for use with Chrome chairs for durability and common finishes. • Ships separate from chair (installation clips included). 	<p>To Order, Specify:</p> <ol style="list-style-type: none"> 1) Product number. (No finish specification required.) 	

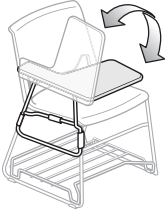
 <p>SCHA-R Class VY – SIN 33721; Discount Group XVIII</p>	Right Tablet Arm	SCHA-R	\$191.69
	Left Tablet Arm	SCHA-L	191.69
<p>Features</p> <ul style="list-style-type: none"> • Ships unassembled. • Flips up for access. • Tablet assembly chrome. • Clearance from tablet to chair back 12.5"(318mm)-15.5"(394mm) angled. • Recommended for use with Chrome chairs for durability and common finishes. • Laminate tablet with matching laminate underside. • Tablet arm size: 15"(381mm)W x 9.8"(249mm)D (Sized to accommodate laptops). • Left or right-hand configurations. <p>Note: Tool from 2474-7601 required for installation. Every order for 1-30 chairs will come with 1 installation tool (ie, a 90 chair order will come with 3 tools).</p>		<p>To Order, Specify:</p> <ol style="list-style-type: none"> 1) Product number. 2) Laminate surface specification. 	

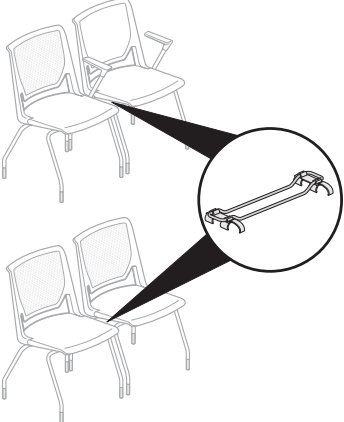
 <p>SCSG-1</p>	Arm to Armless and Armless to Armless	SCSG-1	\$17.80
	Arm to Arm	SCSG-2	18.66
<p>Features</p> <ul style="list-style-type: none"> • Field retrofittable. • Recommended for use on chairs with glides only. • Release for fire safety. 		<p>To Order, Specify:</p> <ol style="list-style-type: none"> 1) Product number. (No finish specification required.) 	

 <p>SCSG-2 Class VY – SIN 33721; Discount Group XVIII</p>			

Very

Accessories

	Description	Number	Price
Stacking Carts	Wire Stacking Cart	SCT-1	\$539.50

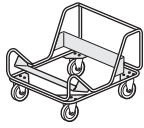

SCT-1

Feature

- For use with Very Wire Stacker seating.

To Order, Specify:

- 1) Product number.
(No color specification required.)

Stacking Carts	Side/Seminar Chairs with Arms	SCT-3	\$451.86
	Side/Seminar Chairs without Arms	SCT-4	\$451.86

SCT-3
SCT-4
Features

- Permits stacking 6-high with glides and casters.
- Standard in black finish color only.

• Cart Only Dimensions:
–SCT-3

25.5"(648mm) H x 27"(685mm) D x 13.8"(352mm) W
(wt: 10.09kg)

–SCT-4

25.5"(648mm) H x 30"(772mm) D x 14.1"(359mm) W
(wt: 10.09kg)

• Cart and Chair Maximum Dimensions:
–SCT-3

65"(1651mm) H x 44"(1118mm) D x 25.5"(648mm) W

–SCT-4

57"(1448mm) H x 44"(1118mm) D x 25.5"(648mm) W

- Not for use with Side Stools.

To Order, Specify:

- 1) Product number.
(No color specification required.)

General Guidelines for Product Specification

	<u>S</u>	<u>J</u>	<u>T</u>	<u>C</u>	<u>2</u>	<u>0</u>	<u>-</u>	<u>7</u>	<u>1</u>	<u>1</u>	<u>A</u>	<u>2</u>	<u>A</u>	<u>3A-18</u>	<u>XT-1</u>	<u>TR-F</u>	<u>TR-LE</u>
Product Type	_____	_____	_____	_____	_____	_____	_____	_____	_____	_____	_____	_____	_____	_____	_____	_____	_____
(S) Seating																	
Product Line	_____	_____	_____	_____	_____	_____	_____	_____	_____	_____	_____	_____	_____	_____	_____	_____	_____
(J) Soji																	
Model (Product Type)	_____	_____	_____	_____	_____	_____	_____	_____	_____	_____	_____	_____	_____	_____	_____	_____	_____
(T) Task																	
Posture (only used for stool)	_____	_____	_____	_____	_____	_____	_____	_____	_____	_____	_____	_____	_____	_____	_____	_____	_____
(C) Stool																	
Seat Upholstery	_____	_____	_____	_____	_____	_____	_____	_____	_____	_____	_____	_____	_____	_____	_____	_____	_____
(1) Leather																	
(2) Fabric																	
(3) Faux Leather																	
Back Upholstery	_____	_____	_____	_____	_____	_____	_____	_____	_____	_____	_____	_____	_____	_____	_____	_____	_____
(0) Knit																	
(1) Leather																	
(2) Fabric																	
(3) Faux Leather																	
(C) Cleanable																	
Arms	_____	_____	_____	_____	_____	_____	_____	_____	_____	_____	_____	_____	_____	_____	_____	_____	_____
(0) No Arms																	
(1) Fixed Arms																	
(4) Height Adjustable Arms																	
(7) 4D Arms																	
Lumbar	_____	_____	_____	_____	_____	_____	_____	_____	_____	_____	_____	_____	_____	_____	_____	_____	_____
(0) No Lumbar																	
(1) Lumbar																	
Back Lock/Forward Tilt	_____	_____	_____	_____	_____	_____	_____	_____	_____	_____	_____	_____	_____	_____	_____	_____	_____
(1) Back Lock																	
(4) Back Lock with Forward Tilt																	
Seat Adjustment	_____	_____	_____	_____	_____	_____	_____	_____	_____	_____	_____	_____	_____	_____	_____	_____	_____
(A) Adjustable																	
(X) Fixed																	
Base	_____	_____	_____	_____	_____	_____	_____	_____	_____	_____	_____	_____	_____	_____	_____	_____	_____
(1) Aluminum Standard Base, Hard Caster																	
(2) Aluminum Standard Base, Soft Caster																	
(3) Aluminum Low Base, Hard Caster																	
(4) Aluminum Low Base, Soft Caster																	
(5) Plastic Standard Base, Hard Caster																	
(6) Plastic Standard Base, Soft Caster																	
(7) Plastic Standard Base, Two-Tone Caster																	
(T) Aluminum Standard Base, Two-Tone Caster																	
Shipping Method	_____	_____	_____	_____	_____	_____	_____	_____	_____	_____	_____	_____	_____	_____	_____	_____	_____
(A) Fully Assembled																	
(K) Knocked Down																	
Seat Upholstery	_____	_____	_____	_____	_____	_____	_____	_____	_____	_____	_____	_____	_____	_____	_____	_____	_____
Tellure																	
Back Upholstery	_____	_____	_____	_____	_____	_____	_____	_____	_____	_____	_____	_____	_____	_____	_____	_____	_____
Knit																	
Trim Color (Plastic components)	_____	_____	_____	_____	_____	_____	_____	_____	_____	_____	_____	_____	_____	_____	_____	_____	_____
Black																	
Base Color (Plastic or Aluminum)	_____	_____	_____	_____	_____	_____	_____	_____	_____	_____	_____	_____	_____	_____	_____	_____	_____
Metallic Silver																	

Soji At-A-Glance

General Specifications

Designer	Haworth Design Studio
Soji	Soji is a highly-adjustable task chair with more ergonomic options than most task seating in its class—without sacrificing comfort or design.
Environmental Factors	Refer to the Product Environmental Data sheet (PED) for recycled content and certifications. Soji is part of the Haworth Take Back Program. Manufactured in a zero landfill, ISO 14001 certified facility in Mississippi, USA.
Finishes and Fabrics	A complete listing of finishes and fabrics for Soji task chairs is available in the back of the price list.
COM & COL General Information	<p>To order a COM fabric (Customer's Own Material) contact the Haworth Inquiry Center (1.800.462.8562), your local Haworth dealer, or go to Surfaces.haworth.com to find out if the COM you have selected has already been tested and approved. The surface collection site also has information on the Haworth alliance program with Carnegie, Luna Textiles, and Maharam as well as our industry-leading Pre-Approved COM program.</p> <p>COM fabrics are placed into Grades based on the cost per linear yard. If a fabric's cost exceeds the range of our highest Grade it will be noted as Non-Graded. The product will be priced at Grade A; the COM fabric costs will appear as a separate line item. The fabric charge will be Haworth's purchase cost plus a 4% administrative fee (based on the cost of the fabric). Yardage calculations will include any applicable fabric repeat.</p> <p>COM Leather products will be priced at a leather Grade A; COL costs will appear as a separate line item. The leather costs will be Haworth's purchase cost plus a 4% administrative fee (based on the cost of the leather).</p>
Stain Repellent	Stain repellent available on fabric seat only. Stain repellent not available on leather or faux leather. To specify add "P" to the end of the product number. Example: SJT-20-711A5AP
Shipping Weights/Cube (Including packaging)	<ul style="list-style-type: none"> • Assembled <ul style="list-style-type: none"> -With arms - 46 lbs. / 16.5 cubic feet -Armless - 41.4 lbs. / 16.5 cubic feet • Knocked Down <ul style="list-style-type: none"> -With arms - 42 lbs. / 12.2 cubic feet -Armless - 37.4 lbs. / 12.2 cubic feet

Soji At-A-Glance

General Specifications

STANDARD MOBILITY AND ADJUSTABILITY

Seat Height Adjustment

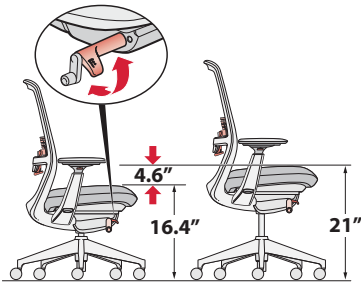

Features:

- Pneumatic seat height adjustment.
- Seat height adjusts 4.6"(117mm) from 16.4"(417mm-533mm) on standard models. Low-position adjusts from 14.75" to 17.5"(375mm-445mm). Stool adjusts from 22" to 29.5"(559mm-749mm).

Benefits:

- Ensures the comfort of the lower limbs by avoiding pressure on the underside of the thigh caused by a seat pan that is too high, or decreased thigh-to-torso angle if the seat is too low.
- Seat height adjustment is important in setting the proper hand position and allowing for proper sitting eye height as well.

Seat Depth Adjustment

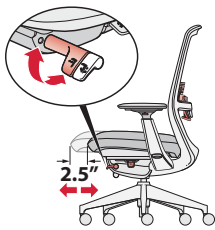

Feature:

- Optional seat depth has 2.5"(64mm) seat depth range. Fixed seat also available.

Benefit:

- Supports the thighs, allows users to rest against the seat back for back support, and avoids pressure on the back of the knees of small to tall users.

Synchronous Tilt Mechanism



Features:

- Back reclines 23° from the upright position.
- 2:1 recline ratio.

Benefits:

- Comfortable relaxed posture.
- Recline allows for the opening of the user's chest cavity providing good airflow to promote alertness.
- User's feet remain flat on the floor.

Tilt Tension Control

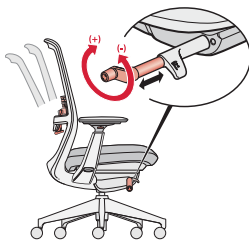

Feature:

- Regulates the amount of resistance felt when leaning back in the chair and the effort required to recline the chair backwards.

Benefit:

- Personalized support to accommodate users of different body types and different work styles.

Forward Tilt

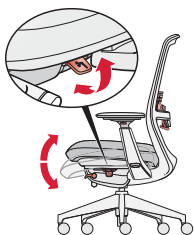

Feature:

- Optional forward tilt allows seat pan to move 5° downward from the initial position.
- Forward tilt not available on task stool.

Benefit:

- Allows user the opportunity to vary their posture throughout the day.

Soji At-A-Glance

General Specifications

STANDARD MOBILITY AND ADJUSTABILITY

Back Lock



Feature:

- Single position back lock.

Benefit:

- Allows users to lock the back of the chair in the upright position for tasking applications.

Lumbar Support

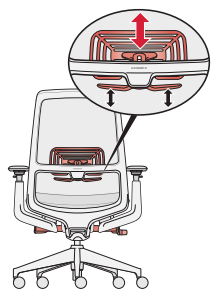

Features:

- Optional height adjustable lumbar.
- Range of 3.5"(89mm) of height adjustment.
- Available in Black or Fog. Lumbar will be black if Carbon knit is ordered or plastic trim color is black. Lumbar will be Fog if plastic trim is specified as Fog or Snow and knit is not Carbon.

Benefits:

- Provides additional support in the lower back.
- Lumbar adjustment maintains the natural curvature of the spine at the lower back and allows the user to position the support to where it is most comfortable.

4D Arm

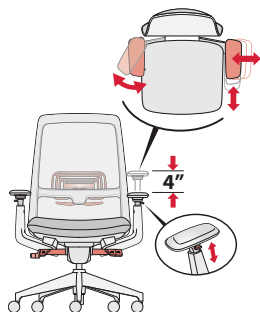

Features:

- Optional 4D arm adjusts in 4 ways:
 - Height adjustment 4"(102mm)
 - Side-to-side arm cap adjustment range: 3"(76mm) [1.5"(38mm) each arm cap]
 - Front-to-back adjustment range: 3.5"(89mm)
 - Pivoting 20° in and 20° out

Benefits:

- Arms support the muscular system of user's neck and shoulders; proper arm support provides back relief.
- Arms can be an aid in standing or sitting down.
- Height adjustment accommodates for users with varying elbow rest heights so that users avoid lifting their shoulders or leaning sideways to get arm support.
- Front-to-back adjustment adjusts the armrest length, which is important because it allows users to get close to the worksurface while maintaining the effective use of the backrest.
- Side-to-side adjustment ensures a comfortable resting position for the arms with proper support of the forearm while allowing for easy entry/exit of the chair.
- Pivoting provides proper support of the forearm when performing tasks involving keying and mousing.

Height Adjustable Arm

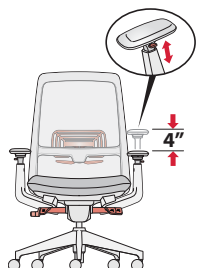

Feature:

- Optional height adjustable arms adjust 4"(102mm) vertically.

Benefit:

- Height adjustment accommodates users with varying elbow rest heights so that users avoid lifting their shoulders or leaning sideways to get arm support.

Soji At-A-Glance

General Specifications

STANDARD MOBILITY AND ADJUSTABILITY

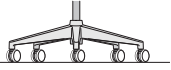
Base**Standard Plastic Base****Colors:**

Fog, Black

Casters:

Hard: Black or Two-Tone Grey

Soft: Black

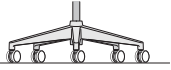
Aluminum Base**Colors:**

Painted Black or Metallic Silver or Polished aluminum

Casters:

Hard: Black or Two-Tone Grey

Soft: Black

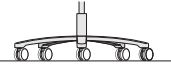
**Low Position Base
(Aluminum only)****Colors:**

Painted Black or Metallic Silver

Casters:

Hard: Black

Soft: Black

Leather Upholstery**Features:**

- Leather will have double stitched seams vertically in the center of the back and seat cushion as well as on the edges of the seat cushion.

Cleanable Upholstery**Features:**

- Seamless Faux Leather inner back.
- Outer back will be backed with Faux Leather for full cleanability.
 - Black trim will default to Wellington Black
 - Fog or Snow trim will default to Wellington Storm
- Inner back for cleanable upholstery must also be specified in Faux Leather. Refer to surfaces.haworth.com for available options.
- To specify, change the back upholstery option to "C". Example: SJT-3C-701X5A

Soji At-A-Glance

General Specifications

Features

Pneumatic seat height adjustment:

- Standard model adjusts 16.4"-21"
- Low position model adjusts 14.75"-17.5"
- Stool adjusts 22"-29.5"

Synchronous tilt mechanism provides 23° of back recline.

Standard tilt mechanism control regulates the amount of resistance of the back.

Standard five-star base in plastic or optional aluminum. Optional low position base in aluminum.

Hard casters available for carpet flooring and soft casters for hard flooring.

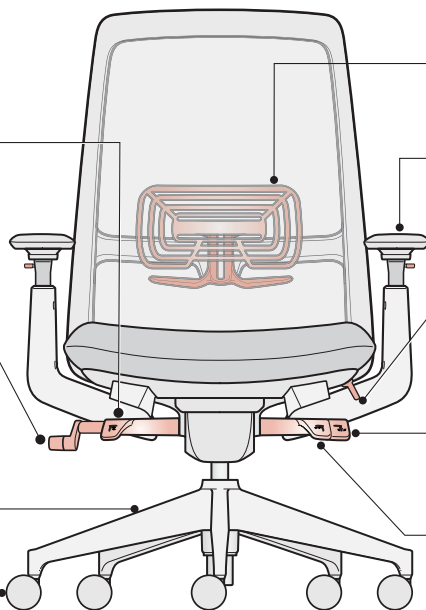

Front View

Optional height adjustable lumbar has 3.5" of height adjustment.

Arms available fixed, height adjustable and 4D; armless.

Optional forward tilt allows seat pan to move downward 5° from the initial position. Forward tilt not available on stool.

Single position back lock to lock back of chair in the upright position.

Seat standard fixed or optional adjustable (2.5" seat depth range).

Aesthetic Options

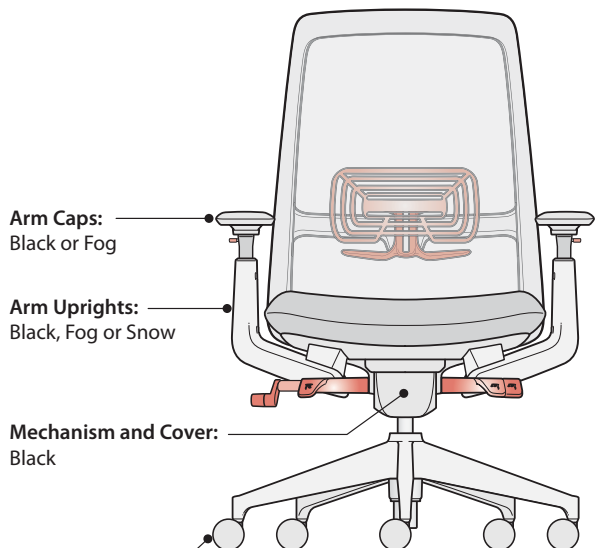

- Arm Caps:**
Black or Fog
- Arm Uprights:**
Black, Fog or Snow
- Mechanism and Cover:**
Black
- Casters:**
• Hard: Black or Two-Tone Grey
• Soft: Black

Front View

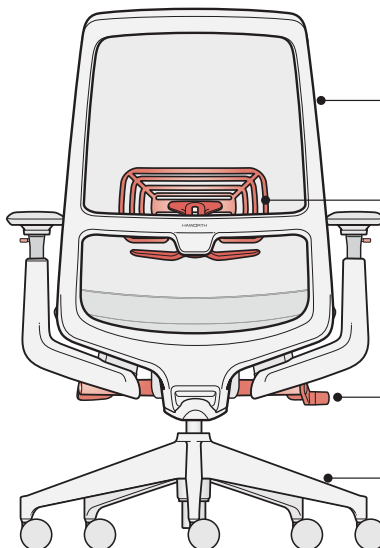

Frame:
Black, Fog or Snow

Lumbar:
Black or Fog

Controls:
Black

Base:
• Plastic: Black or Fog
• Aluminum: Black, Metallic Silver or Polished Aluminum

Back View



SJT-20-711A

Dimensions

- *SH: 16.4"-21.0"
(417mm-533mm)
- H: 39"-44"
(991mm-1118mm)
- D: 27"(686mm)
- W: 28"(711mm)
- *SW: 20"(508mm)
- *SD: 16.25"-18.75"
(413mm-476mm)
- *AH: 7.4"-11.4"
(188mm-290mm)

* All measurements taken with the BIFMA chair measuring device.

Features

- Back: Knit or upholstered.
- Seat: Standard upholstered foam covered in leather, fabric or faux leather. Available as a fixed seat or with seat depth adjustment (2.5"(64mm) range).
- Base: Plastic five-star base.
- Arms: 4D arms have height adjustment range of 4"(102mm). Arms move front to back, side to side and pivot in and out.
- Lumbar: Available with optional lumbar support with 3.5"(89mm) adjustment.
- Mechanism: Synchronized tilt; standard tilt tension adjustment.
- Height adjustment: Standard pneumatic.
- Back Lock: Standard single position upright back lock.
- Optional Forward Tilt: 5° downward from initial position. Only available on chairs with seat depth adjustment.
- Casters: Hard casters in black or two-tone grey; Soft casters black only.
- COM yardage/COL square footage: (Seat only) 0.62/5.6

To Order, Specify:

- 1) Product number, including;
 - 1 Seat Upholstery:**
 - 1 Leather
 - 2 Fabric
 - 3 Faux Leather
 - 2 Back Upholstery:**
 - 0 Knit
 - 1 Leather
 - 2 Fabric
 - 3 Faux Leather
 - 3 Caster Option:**
 - 5 Hard Casters (Black)
 - 6 Soft Casters (Black), add \$45.00 to list
 - 7 Hard Two-Tone Casters (Grey)
- 2) Seat surface material and color.
- 3) Back surface material and color.
- 4) Plastic trim color (frame and arm uprights).
 - TR-F Black
 - TR-7 Fog, add \$72.36 list.
 - TR-UFM Snow, add \$116.88 list.
- 5) Base color.
 - TR-F Black
 - TR-7 Fog

Plastic Trim Color	Lumbar	Arm Caps	Backing Material for Upholstered Back
TR-F Black	TR-F Black	TR-F Black	Tellure, Black 3A-18
TR-7 Fog	TR-7 Fog*	TR-7 Fog	Tellure, Goose 3A-54
TR-UFM Snow	TR-7 Fog*	TR-7 Fog	Tellure, Goose 3A-54

*If knit is Carbon, lumbar will be Black.

Plastic Trim Color	Lumbar	Arm Caps	Backing Material for Cleanable Upholstered Back
TR-F Black	TR-F Black	TR-F Black	Wellington, Black XJ-BL
TR-7 Fog	TR-7 Fog*	TR-7 Fog	Wellington, Steel XJ-SL
TR-UFM Snow	TR-7 Fog*	TR-7 Fog	Wellington, Steel XJ-SL

*If knit is Carbon, lumbar will be Black.

Specification Tips

- Ships standard assembled. Optional knocked down shipment comes in three pieces; assembly does not require tools.
- Lumbar color defaults based on chair attributes and is available in Black or Fog only.
 - Black will be received if Carbon knit is ordered or plastic trim color is Black.
 - Fog will be received if Fog or Snow plastic trim is ordered and knit is not Carbon.
- Reference color chart for applied backing material for upholstered or cleanable upholstery back.

Description	Number	Fabric Grade			A	B	C	D	E	F	G	H	Leather Grade A	Leather Grade B
		1	2	3										
Knit Back, No Lumbar Adjustment														
Back Lock w/Fixed Seat	SJT- 0-701X	A	\$ 780.08	\$ 815.13	\$ 852.70	\$ 870.25	\$ 885.25	\$ 917.82	\$ 947.87	\$ 1028.01	\$ 1099.37	\$ 1255.90		
Back Lock w/Seat Depth Adjustment	SJT- 0-701A	A	802.35	837.40	874.97	892.52	907.52	940.09	970.14	1050.28	1121.64	1278.17		
Back Lock & Forward Tilt w/Seat Depth Adjustment	SJT- 0-704A	A	842.46	877.51	915.08	932.63	947.63	980.20	1010.25	1090.39	1161.75	1318.28		
Upholstered Back, No Lumbar Adjustment														
Back Lock w/Fixed Seat	SJT- -701X	A	\$ 896.77	\$ 966.87	\$ 1042.01	\$ 1077.11	\$ 1107.11	\$ 1172.25	\$ 1232.35	\$ 1392.63	\$ 1535.35	\$ 1848.41		
Back Lock w/Seat Depth Adjustment	SJT- -701A	A	919.04	989.14	1064.28	1099.38	1129.38	1194.52	1254.62	1414.90	1557.62	1870.68		
Back Lock & Forward Tilt w/Seat Depth Adjustment	SJT- -704A	A	959.15	1029.25	1104.39	1139.49	1169.49	1234.63	1294.73	1455.01	1597.73	1910.79		
Knit Back, Lumbar Adjustment														
Back Lock w/Fixed Seat	SJT- 0-711X	A	\$ 833.51	\$ 868.56	\$ 906.13	\$ 923.68	\$ 938.68	\$ 971.25	\$ 1001.30	\$ 1081.44	\$ 1152.80	\$ 1309.33		
Back Lock w/Seat Depth Adjustment	SJT- 0-711A	A	855.78	890.83	928.40	945.95	960.95	993.52	1023.57	1103.71	1175.07	1331.60		
Back Lock & Forward Tilt w/Seat Depth Adjustment	SJT- 0-714A	A	895.89	930.94	968.51	986.06	1001.06	1033.63	1063.68	1143.82	1215.18	1371.71		
Upholstered Back, Lumbar Adjustment														
Back Lock w/Fixed Seat	SJT- -711X	A	\$ 950.20	\$ 1020.30	\$ 1095.44	\$ 1130.54	\$ 1160.54	\$ 1225.68	\$ 1285.78	\$ 1446.06	\$ 1588.78	\$ 1901.84		
Back Lock w/Seat Depth Adjustment	SJT- -711A	A	972.47	1042.57	1117.71	1152.81	1182.81	1247.95	1308.05	1468.33	1611.05	1924.11		
Back Lock & Forward Tilt w/Seat Depth Adjustment	SJT- -714A	A	1012.58	1082.68	1157.82	1192.92	1222.92	1288.06	1348.16	1508.44	1651.16	1964.22		

The following options require modification of the product number.

- Knocked Down Shipment To specify, change the 11th digit from an **A** to **K** and deduct \$33.39 list; **Example:** SJT-20-701X5K
 - Stain Repellent (Fabric seat only) To specify, add **P** to the end of the product number and add \$38.96 list; **Example:** SJT-20-701X5AP
 - Fully Cleanable Back To specify, change the 5th digit to **C** and add \$30.60 list to upholstered back list price; **Example:** SJT-3C-701X5A
- Note:** Inner back must be Faux Leather to have a fully cleanable back.

Soji

Task Chair with 4D Arms — Aluminum Base



SJT-20-711A

Dimensions

- *SH: 16.4"-21.0"
(417mm-533mm)
- H: 39"-44"
(991mm-1118mm)
- D: 27"(686mm)
- W: 28"(711mm)
- *SW: 20"(508mm)
- *SD: 16.25"-18.75"
(413mm-476mm)
- *AH: 7.4"-11.4"
(188mm-290mm)

Low position seat height:
14.75"-17.5"
(375mm-445mm)

* All measurements taken with the BIFMA chair measuring device.

Features

- Back: Knit or upholstered.
- Seat: Standard upholstered foam covered in leather, fabric or faux leather. Available as a fixed seat or with seat depth adjustment (2.5"(64mm) range).
- Base: Aluminum five-star base.
- Arms: 4D arms have height adjustment range of 4"(102mm). Arms move front to back, side to side and pivot in and out.
- Lumbar: Available with optional lumbar support with 3.5"(89mm) adjustment.
- Mechanism: Synchronized tilt; standard tilt tension adjustment.
- Height adjustment: Standard pneumatic.
- Back Lock: Standard single position upright back lock.
- Optional Forward Tilt: 5° downward from initial position. Only available on chairs with seat depth adjustment.
- Casters: Hard casters in black or two-tone grey; Soft casters black only.
- COM yardage/COL square footage: (Seat only) 0.62/5.6

To Order, Specify:

1) Product number, including;

1 Seat Upholstery:

- 1 Leather
- 2 Fabric
- 3 Faux Leather

2 Back Upholstery:

- 0 Knit
- 1 Leather
- 2 Fabric
- 3 Faux Leather

3 Caster Option: Standard Base

- 1 Std. Base Hard Casters (Black)
- 2 Std. Base Soft Casters (Black), add \$45.00 to list
- T Std. Base Hard Two-Tone Casters (Grey)

Low Base

- 3 Low Base, Hard Casters (Black)
- 4 Low Base, Soft Casters (Black), add \$45.00 to list

2) Seat surface material and color.

3) Back surface material and color.

4) Plastic trim color (frame and arm uprights).
TR-F Black
TR-7 Fog, add \$72.36 list.
TR-UFM Snow, add \$116.88 list.

5) Base color.
TR-F Black
TR-LE Metallic Silver
PM-P Polished Aluminum, add \$106.08 list.

Plastic Trim Color	Lumbar	Arm Caps	Backing Material for Upholstered Back
TR-F Black	TR-F Black	TR-F Black	Tellure, Black 3A-18
TR-7 Fog	TR-7 Fog*	TR-7 Fog	Tellure, Goose 3A-54
TR-UFM Snow	TR-7 Fog*	TR-7 Fog	Tellure, Goose 3A-54

*If knit is Carbon, lumbar will be Black.

Plastic Trim Color	Lumbar	Arm Caps	Backing Material for Cleanable Upholstered Back
TR-F Black	TR-F Black	TR-F Black	Wellington, Black XJ-BL
TR-7 Fog	TR-7 Fog*	TR-7 Fog	Wellington, Steel XJ-SL
TR-UFM Snow	TR-7 Fog*	TR-7 Fog	Wellington, Steel XJ-SL

*If knit is Carbon, lumbar will be Black.

Description	Number ① ② ③	Fabric Grade						Leather Grade A	Leather Grade B		
		A	B	C	D	E	F			G	H
Knit Back, No Lumbar Adjustment											
Back Lock w/Fixed Seat	SJT- 0-701X A	\$ 849.26	\$ 884.31	\$ 921.88	\$ 939.43	\$ 954.43	\$ 987.00	\$1017.05	\$1097.19	\$1168.55	\$1325.08
Back Lock w/Seat Depth Adjustment	SJT- 0-701A A	871.53	906.58	944.15	961.70	976.70	1009.27	1039.32	1119.46	1190.82	1347.35
Back Lock & Forward Tilt w/Seat Depth Adjustment	SJT- 0-704A A	911.64	946.69	984.26	1001.81	1016.81	1049.38	1079.43	1159.57	1230.93	1387.46
Upholstered Back, No Lumbar Adjustment											
Back Lock w/Fixed Seat	SJT- -701X A	\$ 965.95	\$1036.05	\$1111.19	\$1146.29	\$1176.29	\$1241.43	\$1301.53	\$1461.81	\$1604.53	\$1917.59
Back Lock w/Seat Depth Adjustment	SJT- -701A A	988.22	1058.32	1133.46	1168.56	1198.56	1263.70	1323.80	1484.08	1626.80	1939.86
Back Lock & Forward Tilt w/Seat Depth Adjustment	SJT- -704A A	1028.33	1098.43	1173.57	1208.67	1238.67	1303.81	1363.91	1524.19	1666.91	1979.97
Knit Back, Lumbar Adjustment											
Back Lock w/Fixed Seat	SJT- 0-711X A	\$ 902.69	\$ 937.74	\$ 975.31	\$ 992.86	\$1007.86	\$1040.43	\$1070.48	\$1150.62	\$1221.98	\$1378.51
Back Lock w/Seat Depth Adjustment	SJT- 0-711A A	924.96	960.01	997.58	1015.13	1030.13	1062.70	1092.75	1172.89	1244.25	1400.78
Back Lock & Forward Tilt w/Seat Depth Adjustment	SJT- 0-714A A	965.07	1000.12	1037.69	1055.24	1070.24	1102.81	1132.86	1213.00	1284.36	1440.89
Upholstered Back, Lumbar Adjustment											
Back Lock w/Fixed Seat	SJT- -711X A	\$1019.38	\$1089.48	\$1164.62	\$1199.72	\$1229.72	\$1294.86	\$1354.96	\$1515.24	\$1657.96	\$1971.02
Back Lock w/Seat Depth Adjustment	SJT- -711A A	1041.65	1111.75	1186.89	1221.99	1251.99	1317.13	1377.23	1537.51	1680.23	1993.29
Back Lock & Forward Tilt w/Seat Depth Adjustment	SJT- -714A A	1081.76	1151.86	1227.00	1262.10	1292.10	1357.24	1417.34	1577.62	1720.34	2033.40

The following options require modification of the product number.

- Knocked Down Shipment
- Stain Repellent (Fabric seat only)
- Fully Cleanable Back

To specify, change the 11th digit from an **A** to **K** and deduct \$33.39 list; **Example:** SJT-20-701X1K

To specify, add **P** to the end of the product number and add \$38.96 list; **Example:** SJT-20-701X1AP

To specify, change the 5th digit to **C** and add \$30.60 list to upholstered back list price; **Example:** SJT-3C-701X1A

Note: Inner back must be Faux Leather to have a fully cleanable back.



SJT-20-401X

Dimensions

- *SH: 16.4"-21.0"
(417mm-533mm)
- H: 39"-44"
(991mm-1118mm)
- D: 27"(686mm)
- W: 28"(711mm)
- *SW: 20"(508mm)
- *SD: 16.25"-18.75"
(413mm-476mm)
- *AH: 7.4"-11.4"
(188mm-290mm)

* All measurements taken with the BIFMA chair measuring device.

Features

- Back: Knit or upholstered.
- Seat: Standard upholstered foam covered in leather, fabric or faux leather. Available as a fixed seat or with seat depth adjustment (2.5"(64mm) range).
- Base: Plastic five-star base.
- Arms: Height adjustable with 4"(102mm) range.
- Lumbar: Available with optional lumbar support with 3.5"(89mm) adjustment.
- Mechanism: Synchronized tilt; standard tilt tension adjustment.
- Height adjustment: Standard pneumatic.
- Back Lock: Standard single position upright back lock.
- Optional Forward Tilt: 5° downward from initial position. Only available on chairs with seat depth adjustment.
- Casters: Hard casters in black or two-tone grey; Soft casters black only.
- COM yardage/COL square footage: (Seat only) 0.62/5.6

To Order, Specify:

1) Product number, including;

1 Seat Upholstery:

- 1 Leather
- 2 Fabric
- 3 Faux Leather

2 Back Upholstery:

- 0 Knit
- 1 Leather
- 2 Fabric
- 3 Faux Leather

3 Caster Option:

- 5 Hard Casters (Black)
- 6 Soft Casters (Black), add \$45.00 to list
- 7 Hard Two-Tone Casters (Grey)

Plastic Trim Color	Lumbar	Arm Caps	Backing Material for Upholstered Back
TR-F Black	TR-F Black	TR-F Black	Tellure, Black 3A-18
TR-7 Fog	TR-7 Fog*	TR-7 Fog	Tellure, Goose 3A-54
TR-UFM Snow	TR-7 Fog*	TR-7 Fog	Tellure, Goose 3A-54

*If knit is Carbon, lumbar will be Black.

Plastic Trim Color	Lumbar	Arm Caps	Backing Material for Cleanable Upholstered Back
TR-F Black	TR-F Black	TR-F Black	Wellington, Black XJ-BL
TR-7 Fog	TR-7 Fog*	TR-7 Fog	Wellington, Steel XJ-SL
TR-UFM Snow	TR-7 Fog*	TR-7 Fog	Wellington, Steel XJ-SL

*If knit is Carbon, lumbar will be Black.

Specification Tips

- Ships standard assembled. Optional knocked down shipment comes in three pieces; assembly does not require tools.
- Lumbar color defaults based on chair attributes and is available in Black or Fog only.
 - Black will be received if Carbon knit is ordered or plastic trim color is Black.
 - Fog will be received if Fog or Snow plastic trim is ordered and knit is not Carbon.
- Reference color chart for applied backing material for upholstered or cleanable upholstery back.

- 2) Seat surface material and color.
- 3) Back surface material and color.
- 4) Plastic trim color (frame and arm uprights).
 - TR-F Black
 - TR-7 Fog, add \$72.36 list.
 - TR-UFM Snow, add \$116.88 list.
- 5) Base color.
 - TR-F Black
 - TR-7 Fog

Description	Number	Fabric Grade			Leather Grade A	Leather Grade B						
		1	2	3								
Knit Back, No Lumbar Adjustment												
Back Lock w/Fixed Seat	SJT- 0-401X	A	\$759.17	\$794.22	\$831.79	\$849.34	\$864.34	\$896.91	\$926.96	\$1007.10	\$1078.46	\$1234.99
Back Lock w/Seat Depth Adjustment	SJT- 0-401A	A	781.44	816.49	854.06	871.61	886.61	919.18	949.23	1029.37	1100.73	1257.26
Back Lock & Forward Tilt w/Seat Depth Adjustment	SJT- 0-404A	A	821.55	856.60	894.17	911.72	926.72	959.29	989.34	1069.48	1140.84	1297.37
Upholstered Back, No Lumbar Adjustment												
Back Lock w/Fixed Seat	SJT- 0-401X	A	\$875.86	\$945.96	\$1021.10	\$1056.20	\$1086.20	\$1151.34	\$1211.44	\$1371.72	\$1514.44	\$1827.50
Back Lock w/Seat Depth Adjustment	SJT- 0-401A	A	898.13	968.23	1043.37	1078.47	1108.47	1173.61	1233.71	1393.99	1536.71	1849.77
Back Lock & Forward Tilt w/Seat Depth Adjustment	SJT- 0-404A	A	938.24	1008.34	1083.48	1118.58	1148.58	1213.72	1273.82	1434.10	1576.82	1889.88
Knit Back, Lumbar Adjustment												
Back Lock w/Fixed Seat	SJT- 0-411X	A	\$812.60	\$847.65	\$885.22	\$902.77	\$917.77	\$950.34	\$980.39	\$1060.53	\$1131.89	\$1288.42
Back Lock w/Seat Depth Adjustment	SJT- 0-411A	A	834.87	869.92	907.49	925.04	940.04	972.61	1002.66	1082.80	1154.16	1310.69
Back Lock & Forward Tilt w/Seat Depth Adjustment	SJT- 0-414A	A	874.98	910.03	947.60	965.15	980.15	1012.72	1042.77	1122.91	1194.27	1350.80
Upholstered Back, Lumbar Adjustment												
Back Lock w/Fixed Seat	SJT- 0-411X	A	\$929.29	\$999.39	\$1074.53	\$1109.63	\$1139.63	\$1204.77	\$1264.87	\$1425.15	\$1567.87	\$1880.93
Back Lock w/Seat Depth Adjustment	SJT- 0-411A	A	951.56	1021.66	1096.80	1131.90	1161.90	1227.04	1287.14	1447.42	1590.14	1903.20
Back Lock & Forward Tilt w/Seat Depth Adjustment	SJT- 0-414A	A	991.67	1061.77	1136.91	1172.01	1202.01	1267.15	1327.25	1487.53	1630.25	1943.31

The following options require modification of the product number.

- Knocked Down Shipment
- Stain Repellent (Fabric seat only)
- Fully Cleanable Back

To specify, change the 11th digit from an A to K and deduct \$33.39 list; **Example:** SJT-20-401XK

To specify, add P to the end of the product number and add \$38.96 list; **Example:** SJT-20-401X5AP

To specify, change the 5th digit to C and add \$30.60 list to upholstered back list price; **Example:** SJT-3C-401X5A

Note: Inner back must be Faux Leather to have a fully cleanable back.

Soji

Task Chair with Height Adjustable Arms — Aluminum Base



SJT-20-411X

Dimensions

- *SH: 16.4"-21.0"
(417mm-533mm)
- H: 39"-44"
(991mm-1118mm)
- D: 27"(686mm)
- W: 28"(711mm)
- *SW: 20"(508mm)
- *SD: 16.25"-18.75"
(413mm-476mm)
- *AH: 7.4"-11.4"
(188mm-290mm)

Low position seat height:
14.75"-17.5"
(375mm-445mm)

* All measurements taken with the BIFMA chair measuring device.

Features

- Back: Knit or upholstered.
- Seat: Standard upholstered foam covered in leather, fabric or faux leather. Available as a fixed seat or with seat depth adjustment (2.5"(64mm) range).
- Base: Aluminum five-star base.
- Arms: Height adjustable with 4"(102mm) range.
- Lumbar: Available with optional lumbar support with 3.5"(89mm) adjustment.
- Mechanism: Synchronized tilt; standard tilt tension adjustment.
- Height adjustment: Standard pneumatic.
- Back Lock: Standard single position upright back lock.
- Optional Forward Tilt: 5° downward from initial position. Only available on chairs with seat depth adjustment.
- Casters: Hard casters in black or two-tone grey; Soft casters black only.
- COM yardage/COL square footage: (Seat only) 0.62/5.6

Specification Tips

- Ships standard assembled. Optional knocked down shipment comes in three pieces; assembly does not require tools.
- Lumbar color defaults based on chair attributes and is available in Black or Fog only.
 - Black will be received if Carbon knit is ordered or plastic trim color is Black.
 - Fog will be received if Fog or Snow plastic trim is ordered and knit is not Carbon.
- Reference color chart for applied backing material for upholstered or cleanable upholstery back.

To Order, Specify:

1) Product number, including;

1 Seat Upholstery:

- 1 Leather
- 2 Fabric
- 3 Faux Leather

2 Back Upholstery:

- 0 Knit
- 1 Leather
- 2 Fabric
- 3 Faux Leather

3 Caster Option: Standard Base

- 1 Std. Base Hard Casters (Black)
- 2 Std. Base Soft Casters (Black), add \$45.00 to list
- T Std. Base Hard Two-Tone Casters (Grey)

Low Base

- 3 Low Base, Hard Casters (Black)
- 4 Low Base, Soft Casters (Black), add \$45.00 to list

- 2) Seat surface material and color.
- 3) Back surface material and color.
- 4) Plastic trim color (frame and arm uprights).
 - TR-F Black
 - TR-7 Fog, add \$72.36 list.
 - TR-UFM Snow, add \$116.88 list.
- 5) Base color.
 - TR-F Black
 - TR-LE Metallic Silver
 - PM-P Polished Aluminum, add \$106.08 list.

Plastic Trim Color	Lumbar	Arm Caps	Backing Material for Upholstered Back
TR-F Black	TR-F Black	TR-F Black	Tellure, Black 3A-18
TR-7 Fog	TR-7 Fog*	TR-7 Fog	Tellure, Goose 3A-54
TR-UFM Snow	TR-7 Fog*	TR-7 Fog	Tellure, Goose 3A-54

*If knit is Carbon, lumbar will be Black.

Plastic Trim Color	Lumbar	Arm Caps	Backing Material for Cleanable Upholstered Back
TR-F Black	TR-F Black	TR-F Black	Wellington, Black XJ-BL
TR-7 Fog	TR-7 Fog*	TR-7 Fog	Wellington, Steel XJ-SL
TR-UFM Snow	TR-7 Fog*	TR-7 Fog	Wellington, Steel XJ-SL

*If knit is Carbon, lumbar will be Black.

Description	Number	Fabric Grade						Leather Grade A	Leather Grade B			
		1	2	3	A	B	C			D	E	F
Knit Back, No Lumbar Adjustment												
Back Lock w/Fixed Seat	SJT- 0-401X	A	\$ 828.35	\$ 863.40	\$ 900.97	\$ 918.52	\$ 933.52	\$ 966.09	\$ 996.14	\$1076.28	\$1147.64	\$1304.17
Back Lock w/Seat Depth Adjustment	SJT- 0-401A	A	850.62	885.67	923.24	940.79	955.79	988.36	1018.41	1098.55	1169.91	1326.44
Back Lock & Forward Tilt w/Seat Depth Adjustment	SJT- 0-404A	A	890.73	925.78	963.35	980.90	995.90	1028.47	1058.52	1138.66	1210.02	1366.55
Upholstered Back, No Lumbar Adjustment												
Back Lock w/Fixed Seat	SJT- -401X	A	\$ 945.04	\$1015.14	\$1090.28	\$1125.38	\$1155.38	\$1220.52	\$1280.62	\$1440.90	\$1583.62	\$1896.68
Back Lock w/Seat Depth Adjustment	SJT- -401A	A	967.31	1037.41	1112.55	1147.65	1177.65	1242.79	1302.89	1463.17	1605.89	1918.95
Back Lock & Forward Tilt w/Seat Depth Adjustment	SJT- -404A	A	1007.42	1077.52	1152.66	1187.76	1217.76	1282.90	1343.00	1503.28	1646.00	1959.06
Knit Back, Lumbar Adjustment												
Back Lock w/Fixed Seat	SJT- 0-411X	A	\$ 881.78	\$ 916.83	\$ 954.40	\$ 971.95	\$ 986.95	\$1019.52	\$1049.57	\$1129.71	\$1201.07	\$1357.60
Back Lock w/Seat Depth Adjustment	SJT- 0-411A	A	904.05	939.10	976.67	994.22	1009.22	1041.79	1071.84	1151.98	1223.34	1379.87
Back Lock & Forward Tilt w/Seat Depth Adjustment	SJT- 0-414A	A	944.16	979.21	1016.78	1034.33	1049.33	1081.90	1111.95	1192.09	1263.45	1419.98
Upholstered Back, Lumbar Adjustment												
Back Lock w/Fixed Seat	SJT- -411X	A	\$ 998.47	\$1068.57	\$1143.71	\$1178.81	\$1208.81	\$1273.95	\$1334.05	\$1494.33	\$1637.05	\$1950.11
Back Lock w/Seat Depth Adjustment	SJT- -411A	A	1020.74	1090.84	1165.98	1201.08	1231.08	1296.22	1356.32	1516.60	1659.32	1972.38
Back Lock & Forward Tilt w/Seat Depth Adjustment	SJT- -414A	A	1060.85	1130.95	1206.09	1241.19	1271.19	1336.33	1396.43	1556.71	1699.43	2012.49

The following options require modification of the product number.

- Knocked Down Shipment
- Stain Repellent (Fabric seat only)
- Fully Cleanable Back

To specify, change the 11th digit from an **A** to **K** and deduct \$33.39 list; **Example:** SJT-20-401X1K

To specify, add **P** to the end of the product number and add \$38.96 list; **Example:** SJT-20-401X1AP

To specify, change the 5th digit to **C** and add \$30.60 list to upholstered back list price; **Example:** SJT-3C-401X1A

Note: Inner back must be Faux Leather to have a fully cleanable back.



SJT-20-111A

Dimensions

- *SH: 16.4"-21.0"
(417mm-533mm)
- H: 39"-44"
(991mm-1118mm)
- D: 27"(686mm)
- W: 28"(711mm)
- *SW: 20"(508mm)
- *SD: 16.25"-18.75"
(413mm-476mm)
- *AH: 9"(229mm)

* All measurements taken with the BIFMA chair measuring device.

Features

- Back: Knit or upholstered.
- Seat: Standard upholstered foam covered in leather, fabric or faux leather. Available as a fixed seat or with seat depth adjustment (2.5"(64mm) range).
- Base: Plastic five-star base.
- Arms: Fixed height.
- Lumbar: Available with optional lumbar support with 3.5"(89mm) adjustment.
- Mechanism: Synchronized tilt; standard tilt tension adjustment.
- Height adjustment: Standard pneumatic.
- Back Lock: Standard single position upright back lock.
- Optional Forward Tilt: 5° downward from initial position. Only available on chairs with seat depth adjustment.
- Casters: Hard casters in black or two-tone grey; Soft casters black only.
- COM yardage/COL square footage: (Seat only) 0.62/5.6

To Order, Specify:

1) Product number, including;

1 Seat Upholstery:

- 1 Leather
- 2 Fabric
- 3 Faux Leather

2 Back Upholstery:

- 0 Knit
- 1 Leather
- 2 Fabric
- 3 Faux Leather

3 Caster Option:

- 5 Hard Casters (Black)
- 6 Soft Casters (Black), add \$45.00 to list
- 7 Hard Two-Tone Casters (Grey)

- 2) Seat surface material and color.
- 3) Back surface material and color.
- 4) Plastic trim color (frame and arm uprights).
TR-F Black
TR-7 Fog, add **\$72.36** list.
TR-UFM Snow, add **\$116.88** list.
- 5) Base color.
TR-F Black
TR-7 Fog

Plastic Trim Color	Lumbar	Arm Caps	Backing Material for Upholstered Back
TR-F Black	TR-F Black	TR-F Black	Tellure, Black 3A-18
TR-7 Fog	TR-7 Fog*	TR-7 Fog	Tellure, Goose 3A-54
TR-UFM Snow	TR-7 Fog*	TR-7 Fog	Tellure, Goose 3A-54

*If knit is Carbon, lumbar will be Black.

Plastic Trim Color	Lumbar	Arm Caps	Backing Material for Cleanable Upholstered Back
TR-F Black	TR-F Black	TR-F Black	Wellington, Black XJ-BL
TR-7 Fog	TR-7 Fog*	TR-7 Fog	Wellington, Steel XJ-SL
TR-UFM Snow	TR-7 Fog*	TR-7 Fog	Wellington, Steel XJ-SL

*If knit is Carbon, lumbar will be Black.

Specification Tips

- Ships standard assembled. Optional knocked down shipment comes in three pieces; assembly does not require tools.
- Lumbar color defaults based on chair attributes and is available in Black or Fog only.
–Black will be received if Carbon knit is ordered or plastic trim color is Black.
–Fog will be received if Fog or Snow plastic trim is ordered and knit is not Carbon.
- Reference color chart for applied backing material for upholstered or cleanable upholstery back.

Description	Number	Fabric Grade			Leather Grade A	Leather Grade B					
		1	2	3							
Knit Back, No Lumbar Adjustment											
Back Lock w/Fixed Seat	SJT- 0-101X A	\$711.39	\$746.44	\$784.01	\$801.56	\$816.56	\$849.13	\$879.18	\$959.32	\$1030.68	\$1187.21
Back Lock w/Seat Depth Adjustment	SJT- 0-101A A	733.66	768.71	806.28	823.83	838.83	871.40	901.45	981.59	1052.95	1209.48
Back Lock & Forward Tilt w/Seat Depth Adjustment	SJT- 0-104A A	773.77	808.82	846.39	863.94	878.94	911.51	941.56	1021.70	1093.06	1249.59
Upholstered Back, No Lumbar Adjustment											
Back Lock w/Fixed Seat	SJT- -101X A	\$828.08	\$898.18	\$973.32	\$1008.42	\$1038.42	\$1103.56	\$1163.66	\$1323.94	\$1466.66	\$1779.72
Back Lock w/Seat Depth Adjustment	SJT- -101A A	850.35	920.45	995.59	1030.69	1060.69	1125.83	1185.93	1346.21	1488.93	1801.99
Back Lock & Forward Tilt w/Seat Depth Adjustment	SJT- -104A A	890.46	960.56	1035.70	1070.80	1100.80	1165.94	1226.04	1386.32	1529.04	1842.10
Knit Back, Lumbar Adjustment											
Back Lock w/Fixed Seat	SJT- 0-111X A	\$764.82	\$799.87	\$837.44	\$854.99	\$869.99	\$902.56	\$932.61	\$1012.75	\$1084.11	\$1240.64
Back Lock w/Seat Depth Adjustment	SJT- 0-111A A	787.09	822.14	859.71	877.26	892.26	924.83	954.88	1035.02	1106.38	1262.91
Back Lock & Forward Tilt w/Seat Depth Adjustment	SJT- 0-114A A	827.20	862.25	899.82	917.37	932.37	964.94	994.99	1075.13	1146.49	1303.02
Upholstered Back, Lumbar Adjustment											
Back Lock w/Fixed Seat	SJT- -111X A	\$881.51	\$951.61	\$1026.75	\$1061.85	\$1091.85	\$1156.99	\$1217.09	\$1377.37	\$1520.09	\$1833.15
Back Lock w/Seat Depth Adjustment	SJT- -111A A	903.78	973.88	1049.02	1084.12	1114.12	1179.26	1239.36	1399.64	1542.36	1855.42
Back Lock & Forward Tilt w/Seat Depth Adjustment	SJT- -114A A	943.89	1013.99	1089.13	1124.23	1154.23	1219.37	1279.47	1439.75	1582.47	1895.53

The following options require modification of the product number.

- Knocked Down Shipment
- Stain Repellent (Fabric seat only)
- Fully Cleanable Back

To specify, change the 11th digit from an **A** to **K** and deduct **\$33.39** list; **Example:** SJT-20-101XK

To specify, add **P** to the end of the product number and add **\$38.96** list; **Example:** SJT-20-101X5AP

To specify, change the 5th digit to **C** and add **\$30.60** list to upholstered back list price; **Example:** SJT-3C-101X5A

Note: Inner back must be Faux Leather to have a fully cleanable back.

Soji

Task Chair with Fixed Arms — Aluminum Base



SJT-20-111A

Dimensions

- *SH: 16.4"-21.0"
(417mm-533mm)
- H: 39"-44"
(991mm-1118mm)
- D: 27"(686mm)
- W: 28"(711mm)
- *SW: 20"(508mm)
- *SD: 16.25"-18.75"
(413mm-476mm)
- *AH: 9"(229mm)

Low position seat height:
14.75"-17.5"
(375mm-445mm)

* All measurements taken with the BIFMA chair measuring device.

Features

- Back: Knit or upholstered.
- Seat: Standard upholstered foam covered in leather, fabric or faux leather. Available as a fixed seat or with seat depth adjustment (3"(76mm) range).
- Base: Aluminum five-star base.
- Arms: Fixed height.
- Lumbar: Available with optional lumbar support with 3.5"(89mm) adjustment.
- Mechanism: Synchronized tilt; standard tilt tension adjustment.
- Height adjustment: Standard pneumatic.
- Back Lock: Standard single position upright back lock.
- Optional Forward Tilt: 5° downward from initial position. Only available on chairs with seat depth adjustment.
- Casters: Hard casters in black or two-tone grey; Soft casters black only.
- COM yardage/COL square footage: (Seat only) 0.62/5.6

Specification Tips

- Ships standard assembled. Optional knocked down shipment comes in three pieces; assembly does not require tools.
- Lumbar color defaults based on chair attributes and is available in Black or Fog only.
 - Black will be received if Carbon knit is ordered or plastic trim color is Black.
 - Fog will be received if Fog or Snow plastic trim is ordered and knit is not Carbon.
- Reference color chart for applied backing material for upholstered or cleanable upholstery back.

To Order, Specify:

- 1) Product number, including;

1 Seat Upholstery:

- 1 Leather
- 2 Fabric
- 3 Faux Leather

2 Back Upholstery:

- 0 Knit
- 1 Leather
- 2 Fabric
- 3 Faux Leather

3 Caster Option: Standard Base

- 1 Std. Base Hard Casters (Black)
- 2 Std. Base Soft Casters (Black), add \$45.00 to list
- T Std. Base Hard Two-Tone Casters (Grey)

Low Base

- 3 Low Base, Hard Casters (Black)
- 4 Low Base, Soft Casters (Black), add \$45.00 to list

- 2) Seat surface material and color.
- 3) Back surface material and color.
- 4) Plastic trim color (frame and arm uprights).
 - TR-F Black
 - TR-7 Fog, add \$72.36 list.
 - TR-UFM Snow, add \$116.88 list.
- 5) Base color.
 - TR-F Black
 - TR-LE Metallic Silver
 - PM-P Polished Aluminum, add \$106.08 list.

Plastic Trim Color	Lumbar	Arm Caps	Backing Material for Upholstered Back
TR-F Black	TR-F Black	TR-F Black	Tellure, Black 3A-18
TR-7 Fog	TR-7 Fog*	TR-7 Fog	Tellure, Goose 3A-54
TR-UFM Snow	TR-7 Fog*	TR-7 Fog	Tellure, Goose 3A-54

*If knit is Carbon, lumbar will be Black.

Plastic Trim Color	Lumbar	Arm Caps	Backing Material for Cleanable Upholstered Back
TR-F Black	TR-F Black	TR-F Black	Wellington, Black XJ-BL
TR-7 Fog	TR-7 Fog*	TR-7 Fog	Wellington, Steel XJ-SL
TR-UFM Snow	TR-7 Fog*	TR-7 Fog	Wellington, Steel XJ-SL

*If knit is Carbon, lumbar will be Black.

Description	Number			Fabric Grade							Leather	Leather	
	1	2	3	A	B	C	D	E	F	G	H	Grade A	Grade B
Knit Back, No Lumbar Adjustment													
Back Lock w/Fixed Seat	SJT-	0-101X	A	\$ 780.57	\$ 815.62	\$ 853.19	\$ 870.74	\$ 885.74	\$ 918.31	\$ 948.36	\$ 1028.50	\$ 1099.86	\$ 1256.39
Back Lock w/Seat Depth Adjustment	SJT-	0-101A	A	802.84	837.89	875.46	893.01	908.01	940.58	970.63	1050.77	1122.13	1278.66
Back Lock & Forward Tilt w/Seat Depth Adjustment	SJT-	0-104A	A	842.95	878.00	915.57	933.12	948.12	980.69	1010.74	1090.88	1162.24	1318.77
Upholstered Back, No Lumbar Adjustment													
Back Lock w/Fixed Seat	SJT-	-101X	A	\$ 897.26	\$ 967.36	\$ 1042.50	\$ 1077.60	\$ 1107.60	\$ 1172.74	\$ 1232.84	\$ 1393.12	\$ 1535.84	\$ 1848.90
Back Lock w/Seat Depth Adjustment	SJT-	-101A	A	919.53	989.63	1064.77	1099.87	1129.87	1195.01	1255.11	1415.39	1558.11	1871.17
Back Lock & Forward Tilt w/Seat Depth Adjustment	SJT-	-104A	A	959.64	1029.74	1104.88	1139.98	1169.98	1235.12	1295.22	1455.50	1598.22	1911.28
Knit Back, Lumbar Adjustment													
Back Lock w/Fixed Seat	SJT-	0-111X	A	\$ 834.00	\$ 869.05	\$ 906.62	\$ 924.17	\$ 939.17	\$ 971.74	\$ 1001.79	\$ 1081.93	\$ 1153.29	\$ 1309.82
Back Lock w/Seat Depth Adjustment	SJT-	0-111A	A	856.27	891.32	928.89	946.44	961.44	994.01	1024.06	1104.20	1175.56	1332.09
Back Lock & Forward Tilt w/Seat Depth Adjustment	SJT-	0-114A	A	896.38	931.43	969.00	986.55	1001.55	1034.12	1064.17	1144.31	1215.67	1372.20
Upholstered Back, Lumbar Adjustment													
Back Lock w/Fixed Seat	SJT-	-111X	A	\$ 950.69	\$ 1020.79	\$ 1095.93	\$ 1131.03	\$ 1161.03	\$ 1226.17	\$ 1286.27	\$ 1446.55	\$ 1589.27	\$ 1902.33
Back Lock w/Seat Depth Adjustment	SJT-	-111A	A	972.96	1043.06	1118.20	1153.30	1183.30	1248.44	1308.54	1468.82	1611.54	1924.60
Back Lock & Forward Tilt w/Seat Depth Adjustment	SJT-	-114A	A	1013.07	1083.17	1158.31	1193.41	1223.41	1288.55	1348.65	1508.93	1651.65	1964.71

The following options require modification of the product number.

- Knocked Down Shipment
- Stain Repellent (Fabric seat only)
- Fully Cleanable Back

To specify, change the 11th digit from an **A** to **K** and deduct \$33.39 list; **Example:** SJT-20-101X1K

To specify, add **P** to the end of the product number and add \$38.96 list; **Example:** SJT-20-101X1AP

To specify, change the 5th digit to **C** and add \$30.60 list to upholstered back list price; **Example:** SJT-3C-101X1A

Note: Inner back must be Faux Leather to have a fully cleanable back.



SJT-20-011A

Dimensions

- *SH: 16.4"-21.0"
(417mm-533mm)
- H: 39"-44"
(991mm-1118mm)
- D: 27"(686mm)
- W: 28"(711mm)
- *SW: 20"(508mm)
- *SD: 16.25"-18.75"
(413mm-476mm)

* All measurements taken with the BIFMA chair measuring device.

Features

- Back: Knit or upholstered.
- Seat: Standard upholstered foam covered in leather, fabric or faux leather. Available as a fixed seat or with seat depth adjustment (2.5"(64mm) range).
- Base: Plastic five-star base.
- Lumbar: Available with optional lumbar support with 3.5"(89mm) adjustment.
- Mechanism: Synchronized tilt; standard tilt tension adjustment.
- Height adjustment: Standard pneumatic.
- Back Lock: Standard single position upright back lock.
- Optional Forward Tilt: 5° downward from initial position. Only available on chairs with seat depth adjustment.
- Casters: Hard casters in black or two-tone grey; Soft casters black only.
- COM yardage/COL square footage: (Seat only) 0.62/5.6

To Order, Specify:

1) Product number, including;

1 Seat Upholstery:

- 1 Leather
- 2 Fabric
- 3 Faux Leather

2 Back Upholstery:

- 0 Knit
- 1 Leather
- 2 Fabric
- 3 Faux Leather

3 Caster Option:

- 5 Hard Casters (Black)
- 6 Soft Casters (Black), add \$45.00 to list
- 7 Hard Two-Tone Casters (Grey)

- 2) Seat surface material and color.
- 3) Back surface material and color.
- 4) Plastic trim color (frame and arm uprights).
TR-F Black
TR-7 Fog, add \$72.36 list.
TR-UFM Snow, add \$116.88 list.
- 5) Base color.
TR-F Black
TR-7 Fog

Specification Tips

- Ships standard assembled. Optional knocked down shipment comes in three pieces; assembly does not require tools.
- Lumbar color defaults based on chair attributes and is available in Black or Fog only.
-Black will be received if Carbon knit is ordered or plastic trim color is Black.
-Fog will be received if Fog or Snow plastic trim is ordered and knit is not Carbon.
- Reference color chart for applied backing material for upholstered or cleanable upholstery back.

Plastic Trim Color	Lumbar	Arm Caps	Backing Material for Upholstered Back
TR-F Black	TR-F Black	TR-F Black	Tellure, Black 3A-18
TR-7 Fog	TR-7 Fog*	TR-7 Fog	Tellure, Goose 3A-54
TR-UFM Snow	TR-7 Fog*	TR-7 Fog	Tellure, Goose 3A-54

*If knit is Carbon, lumbar will be Black.

Plastic Trim Color	Lumbar	Arm Caps	Backing Material for Cleanable Upholstered Back
TR-F Black	TR-F Black	TR-F Black	Wellington, Black XJ-BL
TR-7 Fog	TR-7 Fog*	TR-7 Fog	Wellington, Steel XJ-SL
TR-UFM Snow	TR-7 Fog*	TR-7 Fog	Wellington, Steel XJ-SL

*If knit is Carbon, lumbar will be Black.

Description	Number 1 2 3	Fabric Grade								Leather Grade A	Leather Grade B
		A	B	C	D	E	F	G	H		
Knit Back, No Lumbar Adjustment											
Back Lock w/Fixed Seat	SJT- 0-001X A	\$648.96	\$684.01	\$721.58	\$739.13	\$754.13	\$786.70	\$816.75	\$896.89	\$968.25	\$1124.78
Back Lock w/Seat Depth Adjustment	SJT- 0-001A A	671.23	706.28	743.85	761.40	776.40	808.97	839.02	919.16	990.52	1147.05
Back Lock & Forward Tilt w/Seat Depth Adjustment	SJT- 0-004A A	711.34	746.39	783.96	801.51	816.51	849.08	879.13	959.27	1030.63	1187.16
Upholstered Back, No Lumbar Adjustment											
Back Lock w/Fixed Seat	SJT- -001X A	\$765.65	\$835.75	\$910.89	\$945.99	\$975.99	\$1041.13	\$1101.23	\$1261.51	\$1404.23	\$1717.29
Back Lock w/Seat Depth Adjustment	SJT- -001A A	787.92	858.02	933.16	968.26	998.26	1063.40	1123.50	1283.78	1426.50	1739.56
Back Lock & Forward Tilt w/Seat Depth Adjustment	SJT- -004A A	828.03	898.13	973.27	1008.37	1038.37	1103.51	1163.61	1323.89	1466.61	1779.67
Knit Back, Lumbar Adjustment											
Back Lock w/Fixed Seat	SJT- 0-011X A	\$702.39	\$737.44	\$775.01	\$792.56	\$807.56	\$840.13	\$870.18	\$950.32	\$1021.68	\$1178.21
Back Lock w/Seat Depth Adjustment	SJT- 0-011A A	724.66	759.71	797.28	814.83	829.83	862.40	892.45	972.59	1043.95	1200.48
Back Lock & Forward Tilt w/Seat Depth Adjustment	SJT- 0-014A A	764.77	799.82	837.39	854.94	869.94	902.51	932.56	1012.70	1084.06	1240.59
Upholstered Back, Lumbar Adjustment											
Back Lock w/Fixed Seat	SJT- -011X A	\$819.08	\$889.18	\$964.32	\$999.42	\$1029.42	\$1094.56	\$1154.66	\$1314.94	\$1457.66	\$1770.72
Back Lock w/Seat Depth Adjustment	SJT- -011A A	841.35	911.45	986.59	1021.69	1051.69	1116.83	1176.93	1337.21	1479.93	1792.99
Back Lock & Forward Tilt w/Seat Depth Adjustment	SJT- -014A A	881.46	951.56	1026.70	1061.80	1091.80	1156.94	1217.04	1377.32	1520.04	1833.10

The following options require modification of the product number.

- Knocked Down Shipment
- Stain Repellent (Fabric seat only)
- Fully Cleanable Back

To specify, change the 11th digit from an **A** to **K** and deduct \$33.39 list; **Example:** SJT-20-001X5K
 To specify, add **P** to the end of the product number and add \$38.96 list; **Example:** SJT-20-001X5AP
 To specify, change the 5th digit to **C** and add \$30.60 list to upholstered back list price; **Example:** SJT-3C-001X5A
Note: Inner back must be Faux Leather to have a fully cleanable back.

Soji

Task Chair without Arms — Aluminum Base



SJT-20-011A

Dimensions

- *SH: 16.4"-21.0"
(417mm-533mm)
- H: 39"-44"
(991mm-1118mm)
- D: 27"(686mm)
- W: 28"(711mm)
- *SW: 20"(508mm)
- *SD: 16.25"-18.75"
(413mm-476mm)

Low position seat height:
14.75"-17.5"
(375mm-445mm)

* All measurements taken with the BIFMA chair measuring device.

Features

- Back: Knit or upholstered.
- Seat: Standard upholstered foam covered in leather, fabric or faux leather. Available as a fixed seat or with seat depth adjustment (2.5"(64mm) range).
- Base: Aluminum five-star base.
- Lumbar: Available with optional lumbar support with 3.5"(89mm) adjustment.
- Mechanism: Synchronized tilt; standard tilt tension adjustment.
- Height adjustment: Standard pneumatic.
- Back Lock: Standard single position upright back lock.
- Optional Forward Tilt: 5° downward from initial position. Only available on chairs with seat depth adjustment.
- Casters: Hard casters in black or two-tone grey; Soft casters black only.
- COM yardage/COL square footage: (Seat only) 0.62/5.6

Specification Tips

- Ships standard assembled. Optional knocked down shipment comes in three pieces; assembly does not require tools.
- Lumbar color defaults based on chair attributes and is available in Black or Fog only.
 - Black will be received if Carbon knit is ordered or plastic trim color is Black.
 - Fog will be received if Fog or Snow plastic trim is ordered and knit is not Carbon.
- Reference color chart for applied backing material for upholstered or cleanable upholstery back.

To Order, Specify:

- 1) Product number, including;

1 Seat Upholstery:

- 1 Leather
- 2 Fabric
- 3 Faux Leather

2 Back Upholstery:

- 0 Knit
- 1 Leather
- 2 Fabric
- 3 Faux Leather

3 Caster Option: Standard Base

- 1 Std. Base Hard Casters (Black)
- 2 Std. Base Soft Casters (Black), add \$45.00 to list
- T Std. Base Hard Two-Tone Casters (Grey)

Low Base

- 3 Low Base, Hard Casters (Black)
- 4 Low Base, Soft Casters (Black), add \$45.00 to list

- 2) Seat surface material and color.
- 3) Back surface material and color.
- 4) Plastic trim color (frame and arm uprights).
 - TR-F Black
 - TR-7 Fog, add \$72.36 list.
 - TR-UFM Snow, add \$116.88 list.
- 5) Base color.
 - TR-F Black
 - TR-LE Metallic Silver
 - PM-P Polished Aluminum, add \$106.08 list.

Plastic Trim Color	Lumbar	Arm Caps	Backing Material for Upholstered Back
TR-F Black	TR-F Black	TR-F Black	Tellure, Black 3A-18
TR-7 Fog	TR-7 Fog*	TR-7 Fog	Tellure, Goose 3A-54
TR-UFM Snow	TR-7 Fog*	TR-7 Fog	Tellure, Goose 3A-54

*If knit is Carbon, lumbar will be Black.

Plastic Trim Color	Lumbar	Arm Caps	Backing Material for Cleanable Upholstered Back
TR-F Black	TR-F Black	TR-F Black	Wellington, Black XJ-BL
TR-7 Fog	TR-7 Fog*	TR-7 Fog	Wellington, Steel XJ-SL
TR-UFM Snow	TR-7 Fog*	TR-7 Fog	Wellington, Steel XJ-SL

*If knit is Carbon, lumbar will be Black.

Description	Number			Fabric Grade							Leather	Leather	
	1	2	3	A	B	C	D	E	F	G	H	Grade A	Grade B
Knit Back, No Lumbar Adjustment													
Back Lock w/Fixed Seat	SJT-	0-001X	A	\$718.14	\$753.19	\$790.76	\$808.31	\$823.31	\$855.88	\$885.93	\$966.07	\$1037.43	\$1193.96
Back Lock w/Seat Depth Adjustment	SJT-	0-001A	A	740.41	775.46	813.03	830.58	845.58	878.15	908.20	988.34	1059.70	1216.23
Back Lock & Forward Tilt w/Seat Depth Adjustment	SJT-	0-004A	A	780.52	815.57	853.14	870.69	885.69	918.26	948.31	1028.45	1099.81	1256.34
Upholstered Back, No Lumbar Adjustment													
Back Lock w/Fixed Seat	SJT-	-001X	A	\$834.83	\$904.93	\$980.07	\$1015.17	\$1045.17	\$1110.31	\$1170.41	\$1330.69	\$1473.41	\$1786.47
Back Lock w/Seat Depth Adjustment	SJT-	-001A	A	857.10	927.20	1002.34	1037.44	1067.44	1132.58	1192.68	1352.96	1495.68	1808.74
Back Lock & Forward Tilt w/Seat Depth Adjustment	SJT-	-004A	A	897.21	967.31	1042.45	1077.55	1107.55	1172.69	1232.79	1393.07	1535.79	1848.85
Knit Back, Lumbar Adjustment													
Back Lock w/Fixed Seat	SJT-	0-011X	A	\$771.57	\$806.62	\$844.19	\$861.74	\$876.74	\$909.31	\$939.36	\$1019.50	\$1090.86	\$1247.39
Back Lock w/Seat Depth Adjustment	SJT-	0-011A	A	793.84	828.89	866.46	884.01	899.01	931.58	961.63	1041.77	1113.13	1269.66
Back Lock & Forward Tilt w/Seat Depth Adjustment	SJT-	0-014A	A	833.95	869.00	906.57	924.12	939.12	971.69	1001.74	1081.88	1153.24	1309.77
Upholstered Back, Lumbar Adjustment													
Back Lock w/Fixed Seat	SJT-	-011X	A	\$888.26	\$958.36	\$1033.50	\$1068.60	\$1098.60	\$1163.74	\$1223.84	\$1384.12	\$1526.84	\$1839.90
Back Lock w/Seat Depth Adjustment	SJT-	-011A	A	910.53	980.63	1055.77	1090.87	1120.87	1186.01	1246.11	1406.39	1549.11	1862.17
Back Lock & Forward Tilt w/Seat Depth Adjustment	SJT-	-014A	A	950.64	1020.74	1095.88	1130.98	1160.98	1226.12	1286.22	1446.50	1589.22	1902.28

The following options require modification of the product number.

- Knocked Down Shipment
- Stain Repellent (Fabric seat only)
- Fully Cleanable Back

To specify, change the 11th digit from an **A** to **K** and deduct \$33.39 list; **Example:** SJT-20-001X1K

To specify, add **P** to the end of the product number and add \$38.96 list; **Example:** SJT-20-001X1AP

To specify, change the 5th digit to **C** and add \$30.60 list to upholstered back list price; **Example:** SJT-3C-001X1A

Note: Inner back must be Faux Leather to have a fully cleanable back.



SJTC-701X
SJTC-701A

Dimensions

- *SH: 22"-29.5"
(559mm-749mm)
- H: 44.6"-52.5"
(1133mm-1334mm)
- D: 27"(686mm)
- W: 28"(711mm)
- *SW: 20"(508mm)
- *SD: 16.25"-18.75"
(413mm-476mm)
- *AH: 7.4"-11.4"
(188mm-290mm)

* All measurements taken with the BIFMA chair measuring device.

Features

- Back: Knit or upholstered.
- Seat: Standard upholstered foam covered in leather, fabric or faux leather. Available as a fixed seat or with seat depth adjustment (2.5"(64mm) range).
- Base: Plastic five-star base.
- Arms: 4D arms have height adjustment range of 4"(102mm). Arms move front to back, side to side and pivot in and out.
- Lumbar: Available with optional lumbar support with 3.5"(89mm) adjustment.
- Mechanism: Synchronized tilt; standard tilt tension adjustment.
- Height adjustment: Standard pneumatic.
- Back Lock: Standard single position upright back lock.
- Casters: Hard casters in black or two-tone grey; Soft casters black only.
- COM yardage/COL square footage: (Seat only) 0.62/5.6

To Order, Specify:

1) Product number, including;

1 Seat Upholstery:

- 1 Leather
- 2 Fabric
- 3 Faux Leather

2 Back Upholstery:

- 0 Knit
- 1 Leather
- 2 Fabric
- 3 Faux Leather

3 Caster Option:

- 5 Hard Casters (Black)
- 6 Soft Casters (Black), add \$45.00 to list
- 7 Hard Two-Tone Casters (Grey)

- 2) Seat surface material and color.
- 3) Back surface material and color.
- 4) Plastic trim color (frame and arm uprights).
TR-F Black
TR-7 Fog, add **\$72.36** list.
TR-UFM Snow, add **\$116.88** list.
- 5) Base color.
TR-F Black
TR-7 Fog

Plastic Trim Color	Lumbar	Arm Caps	Backing Material for Upholstered Back
TR-F Black	TR-F Black	TR-F Black	Tellure, Black 3A-18
TR-7 Fog	TR-7 Fog*	TR-7 Fog	Tellure, Goose 3A-54
TR-UFM Snow	TR-7 Fog*	TR-7 Fog	Tellure, Goose 3A-54

*If knit is Carbon, lumbar will be Black.

Plastic Trim Color	Lumbar	Arm Caps	Backing Material for Cleanable Upholstered Back
TR-F Black	TR-F Black	TR-F Black	Wellington, Black XJ-BL
TR-7 Fog	TR-7 Fog*	TR-7 Fog	Wellington, Steel XJ-SL
TR-UFM Snow	TR-7 Fog*	TR-7 Fog	Wellington, Steel XJ-SL

*If knit is Carbon, lumbar will be Black.

Specification Tips

- Ships standard assembled.
- Lumbar color defaults based on chair attributes and is available in Black or Fog only.
–Black will be received if Carbon knit is ordered or plastic trim color is Black.
–Fog will be received if Fog or Snow plastic trim is ordered and knit is not Carbon.
- Reference color chart for applied backing material for upholstered or cleanable upholstery back.

Description	Number ① ② ③	Fabric Grade								Leather Grade A	Leather Grade B	
		A	B	C	D	E	F	G	H			
Knit Back, No Lumbar Adjustment												
Back Lock w/Fixed Seat	SJTC- [] 0-701X [] A	\$1213.58	\$1248.63	\$1286.20	\$1303.75	\$1318.75	\$1351.32	\$1381.37	\$1461.51	\$1532.87	\$1689.40	
Back Lock w/Seat Depth Adjustment	SJTC- [] 0-701A [] A	1235.85	1270.90	1308.47	1326.02	1341.02	1373.59	1403.64	1483.78	1555.14	1711.67	
Upholstered Back, No Lumbar Adjustment												
Back Lock w/Fixed Seat	SJTC- [] [] -701X [] A	\$1330.27	\$1400.37	\$1475.51	\$1510.61	\$1540.61	\$1605.75	\$1665.85	\$1826.13	\$1968.85	\$2281.91	
Back Lock w/Seat Depth Adjustment	SJTC- [] [] -701A [] A	1352.54	1422.64	1497.78	1532.88	1562.88	1628.02	1688.12	1848.40	1991.12	2304.18	
Knit Back, Lumbar Adjustment												
Back Lock w/Fixed Seat	SJTC- [] 0-711X [] A	\$1267.01	\$1302.06	\$1339.63	\$1357.18	\$1372.18	\$1404.75	\$1434.80	\$1514.94	\$1586.30	\$1742.83	
Back Lock w/Seat Depth Adjustment	SJTC- [] 0-711A [] A	1289.28	1324.33	1361.90	1379.45	1394.45	1427.02	1457.07	1537.21	1608.57	1765.10	
Upholstered Back, Lumbar Adjustment												
Back Lock w/Fixed Seat	SJTC- [] [] -711X [] A	\$1383.70	\$1453.80	\$1528.94	\$1564.04	\$1594.04	\$1659.18	\$1719.28	\$1879.56	\$2022.28	\$2335.34	
Back Lock w/Seat Depth Adjustment	SJTC- [] [] -711A [] A	1405.97	1476.07	1551.21	1586.31	1616.31	1681.45	1741.55	1901.83	2044.55	2357.61	

The following options require modification of the product number.

- Stain Repellent (Fabric seat only)
- Fully Cleanable Back

To specify, add **P** to the end of the product number and add **\$38.96** list; **Example:** SJTC-20-701X5AP
To specify, change the 6th digit to **C** and add **\$30.60** list to upholstered back list price; **Example:** SJTC-3C-701X5A
Note: Inner back must be Faux Leather to have a fully cleanable back.

Soji

Task Stool with 4D Arms — Aluminum Base



SJTC-701X
SJTC-701A

Dimensions

- *SH: 22"-29.5"
(559mm-749mm)
- H: 44.6"-52.5"
(1133mm-1334mm)
- D: 27"(686mm)
- W: 28"(711mm)
- *SW: 20"(508mm)
- *SD: 16.25"-18.75"
(413mm-476mm)
- *AH: 7.4"-11.4"
(188mm-290mm)

* All measurements taken with the BIFMA chair measuring device.

Features

- Back: Knit or upholstered.
- Seat: Standard upholstered foam covered in leather, fabric or faux leather. Available as a fixed seat or with seat depth adjustment (2.5"(64mm) range).
- Base: Aluminum five-star base.
- Arms: 4D arms have height adjustment range of 4"(102mm). Arms move front to back, side to side and pivot in and out.
- Lumbar: Available with optional lumbar support with 3.5"(89mm) adjustment.
- Mechanism: Synchronized tilt; standard tilt tension adjustment.
- Height adjustment: Standard pneumatic.
- Back Lock: Standard single position upright back lock.
- Casters: Hard casters in black or two-tone grey; Soft casters black only.
- COM yardage/COL square footage: (Seat only) 0.62/5.6

To Order, Specify:

1) Product number, including;

1 Seat Upholstery:

- 1 Leather
- 2 Fabric
- 3 Faux Leather

2 Back Upholstery:

- 0 Knit
- 1 Leather
- 2 Fabric
- 3 Faux Leather

3 Caster Option: Standard Base

- 1 Std. Base Hard Casters (Black)
- 2 Std. Base Soft Casters (Black), add \$45.00 to list
- T Std. Base Hard Two-Tone Casters (Grey)

2) Seat surface material and color.

3) Back surface material and color.

4) Plastic trim color (frame and arm uprights).
TR-F Black
TR-7 Fog, add \$72.36 list.
TR-UFM Snow, add \$116.88 list.

5) Base color.
TR-F Black
TR-LE Metallic Silver
PM-P Polished Aluminum, add \$106.08 list.

Plastic Trim Color	Lumbar	Arm Caps	Backing Material for Upholstered Back
TR-F Black	TR-F Black	TR-F Black	Tellure, Black 3A-18
TR-7 Fog	TR-7 Fog*	TR-7 Fog	Tellure, Goose 3A-54
TR-UFM Snow	TR-7 Fog*	TR-7 Fog	Tellure, Goose 3A-54

*If knit is Carbon, lumbar will be Black.

Plastic Trim Color	Lumbar	Arm Caps	Backing Material for Cleanable Upholstered Back
TR-F Black	TR-F Black	TR-F Black	Wellington, Black XJ-BL
TR-7 Fog	TR-7 Fog*	TR-7 Fog	Wellington, Steel XJ-SL
TR-UFM Snow	TR-7 Fog*	TR-7 Fog	Wellington, Steel XJ-SL

*If knit is Carbon, lumbar will be Black.

Specification Tips

- Ships standard assembled.
- Lumbar color defaults based on chair attributes and is available in Black or Fog only.
–Black will be received if Carbon knit is ordered or plastic trim color is Black.
–Fog will be received if Fog or Snow plastic trim is ordered and knit is not Carbon.
- Reference color chart for applied backing material for upholstered or cleanable upholstery back.

Description	Number			Fabric Grade							Leather Grade A	Leather Grade B	
	1	2	3	A	B	C	D	E	F	G			H
Knit Back, No Lumbar Adjustment													
Back Lock w/Fixed Seat	SJTC-	0-701X	A	\$1282.76	\$1317.81	\$1355.38	\$1372.93	\$1387.93	\$1420.50	\$1450.55	\$1530.69	\$1602.05	\$1758.58
Back Lock w/Seat Depth Adjustment	SJTC-	0-701A	A	1305.03	1340.08	1377.65	1395.20	1410.20	1442.77	1472.82	1552.96	1624.32	1780.85
Upholstered Back, No Lumbar Adjustment													
Back Lock w/Fixed Seat	SJTC-	-701X	A	\$1399.45	\$1469.55	\$1544.69	\$1579.79	\$1609.79	\$1674.93	\$1735.03	\$1895.31	\$2038.03	\$2351.09
Back Lock w/Seat Depth Adjustment	SJTC-	-701A	A	1421.72	1491.82	1566.96	1602.06	1632.06	1697.20	1757.30	1917.58	2060.30	2373.36
Knit Back, Lumbar Adjustment													
Back Lock w/Fixed Seat	SJTC-	0-711X	A	\$1336.19	\$1371.24	\$1408.81	\$1426.36	\$1441.36	\$1473.93	\$1503.98	\$1584.12	\$1655.48	\$1812.01
Back Lock w/Seat Depth Adjustment	SJTC-	0-711A	A	1358.46	1393.51	1431.08	1448.63	1463.63	1496.20	1526.25	1606.39	1677.75	1834.28
Upholstered Back, Lumbar Adjustment													
Back Lock w/Fixed Seat	SJTC-	-711X	A	\$1452.88	\$1522.98	\$1598.12	\$1633.22	\$1663.22	\$1728.36	\$1788.46	\$1948.74	\$2091.46	\$2404.52
Back Lock w/Seat Depth Adjustment	SJTC-	-711A	A	1475.15	1545.25	1620.39	1655.49	1685.49	1750.63	1810.73	1971.01	2113.73	2426.79

The following options require modification of the product number.

- Stain Repellent (Fabric seat only)
- Fully Cleanable Back

To specify, add **P** to the end of the product number and add \$38.96 list; **Example:** SJTC-20-701X1AP

To specify, change the 6th digit to **C** and add \$30.60 list to upholstered back list price; **Example:** SJTC-3C-701X1A

Note: Inner back must be Faux Leather to have a fully cleanable back.



SJTC-401X
SJTC-401A

Dimensions

- *SH: 22"-29.5"
(559mm-749mm)
- H: 44.6"-52.5"
(1133mm-1334mm)
- D: 27"(686mm)
- W: 28"(711mm)
- *SW: 20"(508mm)
- *SD: 16.25"-18.75"
(413mm-476mm)
- *AH: 7.4"-11.4"
(188mm-290mm)

* All measurements taken with the BIFMA chair measuring device.

Features

- Back: Knit or upholstered.
- Seat: Standard upholstered foam covered in leather, fabric or faux leather. Available as a fixed seat or with seat depth adjustment (2.5"(64mm) range).
- Base: Plastic five-star base.
- Arms: Height adjustable with 4"(102mm) range.
- Lumbar: Available with optional lumbar support with 3.5"(89mm) adjustment.
- Mechanism: Synchronized tilt; standard tilt tension adjustment.
- Height adjustment: Standard pneumatic.
- Back Lock: Standard single position upright back lock.
- Casters: Hard casters in black or two-tone grey; Soft casters black only.
- COM yardage/COL square footage: (Seat only) 0.62/5.6

Specification Tips

- Ships standard assembled.
- Lumbar color defaults based on chair attributes and is available in Black or Fog only.
 - Black will be received if Carbon knit is ordered or plastic trim color is Black.
 - Fog will be received if Fog or Snow plastic trim is ordered and knit is not Carbon.
- Reference color chart for applied backing material for upholstered or cleanable upholstery back.

To Order, Specify:

1) Product number, including;

1 Seat Upholstery:

- 1 Leather
- 2 Fabric
- 3 Faux Leather

2 Back Upholstery:

- 0 Knit
- 1 Leather
- 2 Fabric
- 3 Faux Leather

3 Caster Option:

- 5 Hard Casters (Black)
- 6 Soft Casters (Black), add \$45.00 to list
- 7 Hard Two-Tone Casters (Grey)

- 2) Seat surface material and color.
- 3) Back surface material and color.
- 4) Plastic trim color (frame and arm uprights).
 - TR-F Black
 - TR-7 Fog, add **\$72.36** list.
 - TR-UFM Snow, add **\$116.88** list.
- 5) Base color.
 - TR-F Black
 - TR-7 Fog

Plastic Trim Color	Lumbar	Arm Caps	Backing Material for Upholstered Back
TR-F Black	TR-F Black	TR-F Black	Tellure, Black 3A-18
TR-7 Fog	TR-7 Fog*	TR-7 Fog	Tellure, Goose 3A-54
TR-UFM Snow	TR-7 Fog*	TR-7 Fog	Tellure, Goose 3A-54

*If knit is Carbon, lumbar will be Black.

Plastic Trim Color	Lumbar	Arm Caps	Backing Material for Cleanable Upholstered Back
TR-F Black	TR-F Black	TR-F Black	Wellington, Black XJ-BL
TR-7 Fog	TR-7 Fog*	TR-7 Fog	Wellington, Steel XJ-SL
TR-UFM Snow	TR-7 Fog*	TR-7 Fog	Wellington, Steel XJ-SL

*If knit is Carbon, lumbar will be Black.

Description	Number	①	②	③	Fabric Grade								Leather Grade A	Leather Grade B
					A	B	C	D	E	F	G	H		
Knit Back, No Lumbar Adjustment														
Back Lock w/Fixed Seat	SJTC-	0-401X	A		\$1192.67	\$1227.72	\$1265.29	\$1282.84	\$1297.84	\$1330.41	\$1360.46	\$1440.60	\$1511.96	\$1668.49
Back Lock w/Seat Depth Adjustment	SJTC-	0-401A	A		1214.94	1249.99	1287.56	1305.11	1320.11	1352.68	1382.73	1462.87	1534.23	1690.76
Upholstered Back, No Lumbar Adjustment														
Back Lock w/Fixed Seat	SJTC-	-401X	A		\$1309.36	\$1379.46	\$1454.60	\$1489.70	\$1519.70	\$1584.84	\$1644.94	\$1805.22	\$1947.94	\$2261.00
Back Lock w/Seat Depth Adjustment	SJTC-	-401A	A		1331.63	1401.73	1476.87	1511.97	1541.97	1607.11	1667.21	1827.49	1970.21	2283.27
Knit Back, Lumbar Adjustment														
Back Lock w/Fixed Seat	SJTC-	0-411X	A		\$1246.10	\$1281.15	\$1318.72	\$1336.27	\$1351.27	\$1383.84	\$1413.89	\$1494.03	\$1565.39	\$1721.92
Back Lock w/Seat Depth Adjustment	SJTC-	0-411A	A		1268.37	1303.42	1340.99	1358.54	1373.54	1406.11	1436.16	1516.30	1587.66	1744.19
Upholstered Back, Lumbar Adjustment														
Back Lock w/Fixed Seat	SJTC-	-411X	A		\$1362.79	\$1432.89	\$1508.03	\$1543.13	\$1573.13	\$1638.27	\$1698.37	\$1858.65	\$2001.37	\$2314.43
Back Lock w/Seat Depth Adjustment	SJTC-	-411A	A		1385.06	1455.16	1530.30	1565.40	1595.40	1660.54	1720.64	1880.92	2023.64	2336.70

The following options require modification of the product number.

- Stain Repellent (Fabric seat only)
- Fully Cleanable Back

To specify, add **P** to the end of the product number and add **\$38.96** list; **Example:** SJTC-20-401X5AP
 To specify, change the 6th digit to **C** and add **\$30.60** list to upholstered back list price; **Example:** SJTC-3C-401X5A
Note: Inner back must be Faux Leather to have a fully cleanable back.

Soji

Task Stool with Height Adjustable Arms — Aluminum Base



SJTC-401X
SJTC-401A

Dimensions

- *SH: 22"-29.5"
(559mm-749mm)
- H: 44.6"-52.5"
(1133mm-1334mm)
- D: 27"(686mm)
- W: 28"(711mm)
- *SW: 20"(508mm)
- *SD: 16.25"-18.75"
(413mm-476mm)
- *AH: 7.4"-11.4"
(188mm-290mm)

* All measurements taken with the BIFMA chair measuring device.

Features

- Back: Knit or upholstered.
- Seat: Standard upholstered foam covered in leather, fabric or faux leather. Available as a fixed seat or with seat depth adjustment (2.5"(64mm) range).
- Base: Aluminum five-star base.
- Arms: Height adjustable with 4"(102mm) range.
- Lumbar: Available with optional lumbar support with 3.5"(89mm) adjustment.
- Mechanism: Synchronized tilt; standard tilt tension adjustment.
- Height adjustment: Standard pneumatic.
- Back Lock: Standard single position upright back lock.
- Casters: Hard casters in black or two-tone grey; Soft casters black only.
- COM yardage/COL square footage: (Seat only) 0.62/5.6

Specification Tips

- Ships standard assembled.
- Lumbar color defaults based on chair attributes and is available in Black or Fog only.
 - Black will be received if Carbon knit is ordered or plastic trim color is Black.
 - Fog will be received if Fog or Snow plastic trim is ordered and knit is not Carbon.
- Reference color chart for applied backing material for upholstered or cleanable upholstery back.

To Order, Specify:

1) Product number, including;

1 Seat Upholstery:

- 1 Leather
- 2 Fabric
- 3 Faux Leather

2 Back Upholstery:

- 0 Knit
- 1 Leather
- 2 Fabric
- 3 Faux Leather

3 Caster Option: Standard Base

- 1 Std. Base Hard Casters (Black)
- 2 Std. Base Soft Casters (Black), add \$45.00 to list
- T Std. Base Hard Two-Tone Casters (Grey)

- 2) Seat surface material and color.
- 3) Back surface material and color.
- 4) Plastic trim color (frame and arm uprights).
 - TR-F Black
 - TR-7 Fog, add \$72.36 list.
 - TR-UFM Snow, add \$116.88 list.
- 5) Base color.
 - TR-F Black
 - TR-LE Metallic Silver
 - PM-P Polished Aluminum, add \$106.08 list.

Plastic Trim Color	Lumbar	Arm Caps	Backing Material for Upholstered Back
TR-F Black	TR-F Black	TR-F Black	Tellure, Black 3A-18
TR-7 Fog	TR-7 Fog*	TR-7 Fog	Tellure, Goose 3A-54
TR-UFM Snow	TR-7 Fog*	TR-7 Fog	Tellure, Goose 3A-54

*If knit is Carbon, lumbar will be Black.

Plastic Trim Color	Lumbar	Arm Caps	Backing Material for Cleanable Upholstered Back
TR-F Black	TR-F Black	TR-F Black	Wellington, Black XJ-BL
TR-7 Fog	TR-7 Fog*	TR-7 Fog	Wellington, Steel XJ-SL
TR-UFM Snow	TR-7 Fog*	TR-7 Fog	Wellington, Steel XJ-SL

*If knit is Carbon, lumbar will be Black.

Description	Number			Fabric Grade								Leather Grade A	Leather Grade B
	1	2	3	A	B	C	D	E	F	G	H		
Knit Back, No Lumbar Adjustment													
Back Lock w/Fixed Seat	SJTC-	0-401X	A	\$1261.85	\$1296.90	\$1334.47	\$1352.02	\$1367.02	\$1399.59	\$1429.64	\$1509.78	\$1581.14	\$1737.67
Back Lock w/Seat Depth Adjustment	SJTC-	0-401A	A	1284.12	1319.17	1356.74	1374.29	1389.29	1421.86	1451.91	1532.05	1603.41	1759.94
Upholstered Back, No Lumbar Adjustment													
Back Lock w/Fixed Seat	SJTC-	-401X	A	\$1378.54	\$1448.64	\$1523.78	\$1558.88	\$1588.88	\$1654.02	\$1714.12	\$1874.40	\$2017.12	\$2330.18
Back Lock w/Seat Depth Adjustment	SJTC-	-401A	A	1400.81	1470.91	1546.05	1581.15	1611.15	1676.29	1736.39	1896.67	2039.39	2352.45
Knit Back, Lumbar Adjustment													
Back Lock w/Fixed Seat	SJTC-	0-411X	A	\$1315.28	\$1350.33	\$1387.90	\$1405.45	\$1420.45	\$1453.02	\$1483.07	\$1563.21	\$1634.57	\$1791.10
Back Lock w/Seat Depth Adjustment	SJTC-	0-411A	A	1337.55	1372.60	1410.17	1427.72	1442.72	1475.29	1505.34	1585.48	1656.84	1813.37
Upholstered Back, Lumbar Adjustment													
Back Lock w/Fixed Seat	SJTC-	-411X	A	\$1431.97	\$1502.07	\$1577.21	\$1612.31	\$1642.31	\$1707.45	\$1767.55	\$1927.83	\$2070.55	\$2383.61
Back Lock w/Seat Depth Adjustment	SJTC-	-411A	A	1454.24	1524.34	1599.48	1634.58	1664.58	1729.72	1789.82	1950.10	2092.82	2405.88

The following options require modification of the product number.

- Stain Repellent (Fabric seat only)
- Fully Cleanable Back

To specify, add **P** to the end of the product number and add \$38.96 list; **Example:** SJTC-20-401X1AP

To specify, change the 6th digit to **C** and add \$30.60 list to upholstered back list price; **Example:** SJTC-3C-401X1A

Note: Inner back must be Faux Leather to have a fully cleanable back.



SJTC-101X
SJTC-101A

Dimensions

- *SH: 22"-29.5"
(559mm-749mm)
- H: 44.6"-52.5"
(1133mm-1334mm)
- D: 27"(686mm)
- W: 28"(711mm)
- *SW: 20"(508mm)
- *SD: 16.25"-18.75"
(413mm-476mm)
- *AH: 9"(229mm)

* All measurements taken with the BIFMA chair measuring device.

Features

- Back: Knit or upholstered.
- Seat: Standard upholstered foam covered in leather, fabric or faux leather. Available as a fixed seat or with seat depth adjustment (2.5"(64mm) range).
- Base: Plastic five-star base.
- Arms: Fixed height.
- Lumbar: Available with optional lumbar support with 3.5"(89mm) adjustment.
- Mechanism: Synchronized tilt; standard tilt tension adjustment.
- Height adjustment: Standard pneumatic.
- Back Lock: Standard single position upright back lock.
- Casters: Hard casters in black or two-tone grey; Soft casters black only.
- COM yardage/COL square footage: (Seat only) 0.62/5.6

Specification Tips

- Ships standard assembled.
- Lumbar color defaults based on chair attributes and is available in Black or Fog only.
 - Black will be received if Carbon knit is ordered or plastic trim color is Black.
 - Fog will be received if Fog or Snow plastic trim is ordered and knit is not Carbon.
- Reference color chart for applied backing material for upholstered or cleanable upholstery back.

To Order, Specify:

1) Product number, including;

1 Seat Upholstery:

- 1 Leather
- 2 Fabric
- 3 Faux Leather

2 Back Upholstery:

- 0 Knit
- 1 Leather
- 2 Fabric
- 3 Faux Leather

3 Caster Option:

- 5 Hard Casters (Black)
- 6 Soft Casters (Black), add \$45.00 to list
- 7 Hard Two-Tone Casters (Grey)

- 2) Seat surface material and color.
- 3) Back surface material and color.
- 4) Plastic trim color (frame and arm uprights).
 - TR-F Black
 - TR-7 Fog, add **\$72.36** list.
 - TR-UFM Snow, add **\$116.88** list.
- 5) Base color.
 - TR-F Black
 - TR-7 Fog

Plastic Trim Color	Lumbar	Arm Caps	Backing Material for Upholstered Back
TR-F Black	TR-F Black	TR-F Black	Tellure, Black 3A-18
TR-7 Fog	TR-7 Fog*	TR-7 Fog	Tellure, Goose 3A-54
TR-UFM Snow	TR-7 Fog*	TR-7 Fog	Tellure, Goose 3A-54

*If knit is Carbon, lumbar will be Black.

Plastic Trim Color	Lumbar	Arm Caps	Backing Material for Cleanable Upholstered Back
TR-F Black	TR-F Black	TR-F Black	Wellington, Black XJ-BL
TR-7 Fog	TR-7 Fog*	TR-7 Fog	Wellington, Steel XJ-SL
TR-UFM Snow	TR-7 Fog*	TR-7 Fog	Wellington, Steel XJ-SL

*If knit is Carbon, lumbar will be Black.

Description	Number	①	②	③	Fabric Grade								Leather Grade A	Leather Grade B
					A	B	C	D	E	F	G	H		
Knit Back, No Lumbar Adjustment														
Back Lock w/Fixed Seat	SJTC-	0-101X	A		\$1144.89	\$1179.94	\$1217.51	\$1235.06	\$1250.06	\$1282.63	\$1312.68	\$1392.82	\$1464.18	\$1620.71
Back Lock w/Seat Depth Adjustment	SJTC-	0-101A	A		1167.16	1202.21	1239.78	1257.33	1272.33	1304.90	1334.95	1415.09	1486.45	1642.98
Upholstered Back, No Lumbar Adjustment														
Back Lock w/Fixed Seat	SJTC-	-101X	A		\$1261.58	\$1331.68	\$1406.82	\$1441.92	\$1471.92	\$1537.06	\$1597.16	\$1757.44	\$1900.16	\$2213.22
Back Lock w/Seat Depth Adjustment	SJTC-	-101A	A		1283.85	1353.95	1429.09	1464.19	1494.19	1559.33	1619.43	1779.71	1922.43	2235.49
Knit Back, Lumbar Adjustment														
Back Lock w/Fixed Seat	SJTC-	0-111X	A		\$1198.32	\$1233.37	\$1270.94	\$1288.49	\$1303.49	\$1336.06	\$1366.11	\$1446.25	\$1517.61	\$1674.14
Back Lock w/Seat Depth Adjustment	SJTC-	0-111A	A		1220.59	1255.64	1293.21	1310.76	1325.76	1358.33	1388.38	1468.52	1539.88	1696.41
Upholstered Back, Lumbar Adjustment														
Back Lock w/Fixed Seat	SJTC-	-111X	A		\$1315.01	\$1385.11	\$1460.25	\$1495.35	\$1525.35	\$1590.49	\$1650.59	\$1810.87	\$1953.59	\$2266.65
Back Lock w/Seat Depth Adjustment	SJTC-	-111A	A		1337.28	1407.38	1482.52	1517.62	1547.62	1612.76	1672.86	1833.14	1975.86	2288.92

The following options require modification of the product number.

- Stain Repellent (Fabric seat only)
- Fully Cleanable Back

To specify, add **P** to the end of the product number and add **\$38.96** list; **Example:** SJTC-20-101X5AP
 To specify, change the 6th digit to **C** and add **\$30.60** list to upholstered back list price; **Example:** SJTC-3C-101X5A
Note: Inner back must be Faux Leather to have a fully cleanable back.

Soji

Task Stool with Fixed Arms — Aluminum Base



SJTC-101X
SJTC-101A

- Dimensions**
- *SH: 22"-29.5"
(559mm-749mm)
 - H: 44.6"-52.5"
(1133mm-1334mm)
 - D: 27"(686mm)
 - W: 28"(711mm)
 - *SW: 20"(508mm)
 - *SD: 16.25"-18.75"
(413mm-476mm)
 - *AH: 9"(229mm)

* All measurements taken with the BIFMA chair measuring device.

- Features**
- Back: Knit or upholstered.
 - Seat: Standard upholstered foam covered in leather, fabric or faux leather. Available as a fixed seat or with seat depth adjustment (3"(76mm) range).
 - Base: Aluminum five-star base.
 - Arms: Fixed height.
 - Lumbar: Available with optional lumbar support with 3.5"(89mm) adjustment.
 - Mechanism: Synchronized tilt; standard tilt tension adjustment.
 - Height adjustment: Standard pneumatic.
 - Back Lock: Standard single position upright back lock.
 - Casters: Hard casters in black or two-tone grey; Soft casters black only.
 - COM yardage/COL square footage: (Seat only) 0.62/5.6

To Order, Specify:

- 1) Product number, including;

1 Seat Upholstery:

- 1 Leather
- 2 Fabric
- 3 Faux Leather

2 Back Upholstery:

- 0 Knit
- 1 Leather
- 2 Fabric
- 3 Faux Leather

3 Caster Option: Standard Base

- 1 Std. Base Hard Casters (Black)
- 2 Std. Base Soft Casters (Black), add **\$45.00** to list
- T Std. Base Hard Two-Tone Casters (Grey)

- 2) Seat surface material and color.
- 3) Back surface material and color.
- 4) Plastic trim color (frame and arm uprights).
TR-F Black
TR-7 Fog, add **\$72.36** list.
TR-UFM Snow, add **\$116.88** list.
- 5) Base color.
TR-F Black
TR-LE Metallic Silver
PM-P Polished Aluminum, add **\$106.08** list.

Plastic Trim Color	Lumbar	Arm Caps	Backing Material for Upholstered Back
TR-F Black	TR-F Black	TR-F Black	Tellure, Black 3A-18
TR-7 Fog	TR-7 Fog*	TR-7 Fog	Tellure, Goose 3A-54
TR-UFM Snow	TR-7 Fog*	TR-7 Fog	Tellure, Goose 3A-54

*If knit is Carbon, lumbar will be Black.

Plastic Trim Color	Lumbar	Arm Caps	Backing Material for Cleanable Upholstered Back
TR-F Black	TR-F Black	TR-F Black	Wellington, Black XJ-BL
TR-7 Fog	TR-7 Fog*	TR-7 Fog	Wellington, Steel XJ-SL
TR-UFM Snow	TR-7 Fog*	TR-7 Fog	Wellington, Steel XJ-SL

*If knit is Carbon, lumbar will be Black.

Description	Number			Fabric Grade								Leather Grade A	Leather Grade B	
	1	2	3	A	B	C	D	E	F	G	H			
Knit Back, No Lumbar Adjustment														
Back Lock w/Fixed Seat	SJTC-	0-	101X	A	\$1214.07	\$1249.12	\$1286.69	\$1304.24	\$1319.24	\$1351.81	\$1381.86	\$1462.00	\$1533.36	\$1689.89
Back Lock w/Seat Depth Adjustment	SJTC-	0-	101A	A	1236.34	1271.39	1308.96	1326.51	1341.51	1374.08	1404.13	1484.27	1555.63	1712.16
Upholstered Back, No Lumbar Adjustment														
Back Lock w/Fixed Seat	SJTC-		-101X	A	\$1330.76	\$1400.86	\$1476.00	\$1511.10	\$1541.10	\$1606.24	\$1666.34	\$1826.62	\$1969.34	\$2282.40
Back Lock w/Seat Depth Adjustment	SJTC-		-101A	A	1353.03	1423.13	1498.27	1533.37	1563.37	1628.51	1688.61	1848.89	1991.61	2304.67
Knit Back, Lumbar Adjustment														
Back Lock w/Fixed Seat	SJTC-	0-	111X	A	\$1267.50	\$1302.55	\$1340.12	\$1357.67	\$1372.67	\$1405.24	\$1435.29	\$1515.43	\$1586.79	\$1743.32
Back Lock w/Seat Depth Adjustment	SJTC-	0-	111A	A	1289.77	1324.82	1362.39	1379.94	1394.94	1427.51	1457.56	1537.70	1609.06	1765.59
Upholstered Back, Lumbar Adjustment														
Back Lock w/Fixed Seat	SJTC-		-111X	A	\$1384.19	\$1454.29	\$1529.43	\$1564.53	\$1594.53	\$1659.67	\$1719.77	\$1880.05	\$2022.77	\$2335.83
Back Lock w/Seat Depth Adjustment	SJTC-		-111A	A	1406.46	1476.56	1551.70	1586.80	1616.80	1681.94	1742.04	1902.32	2045.04	2358.10

The following options require modification of the product number.

- Stain Repellent (Fabric seat only)
- Fully Cleanable Back

To specify, add **P** to the end of the product number and add **\$38.96** list; **Example:** SJTC-20-101X1AP

To specify, change the 6th digit to **C** and add **\$30.60** list to upholstered back list price; **Example:** SJTC-3C-101X1A

Note: Inner back must be Faux Leather to have a fully cleanable back.



SJTC-001X
SJTC-001A

Dimensions

- *SH: 22"-29.5"
(559mm-749mm)
- H: 44.6"-52.5"
(1133mm-1334mm)
- D: 27"(686mm)
- W: 28"(711mm)
- *SW: 20"(508mm)
- *SD: 16.25"-18.75"
(413mm-476mm)

* All measurements taken with the BIFMA chair measuring device.

Features

- Back: Knit or upholstered.
- Seat: Standard upholstered foam covered in leather, fabric or faux leather. Available as a fixed seat or with seat depth adjustment (2.5"(64mm) range).
- Base: Plastic five-star base.
- Lumbar: Available with optional lumbar support with 3.5"(89mm) adjustment.
- Mechanism: Synchronized tilt; standard tilt tension adjustment.
- Height adjustment: Standard pneumatic.
- Back Lock: Standard single position upright back lock.
- Casters: Hard casters in black or two-tone grey; Soft casters black only.
- COM yardage/COL square footage: (Seat only) 0.62/5.6

To Order, Specify:

1) Product number, including;

1 Seat Upholstery:

- 1 Leather
- 2 Fabric
- 3 Faux Leather

2 Back Upholstery:

- 0 Knit
- 1 Leather
- 2 Fabric
- 3 Faux Leather

3 Caster Option:

- 5 Hard Casters (Black)
- 6 Soft Casters (Black), add \$45.00 to list
- 7 Hard Two-Tone Casters (Grey)

- 2) Seat surface material and color.
- 3) Back surface material and color.
- 4) Plastic trim color (frame and arm uprights).
TR-F Black
TR-7 Fog, add \$72.36 list.
TR-UFM Snow, add \$116.88 list.
- 5) Base color.
TR-F Black
TR-7 Fog

Specification Tips

- Ships standard assembled.
- Lumbar color defaults based on chair attributes and is available in Black or Fog only.
–Black will be received if Carbon knit is ordered or plastic trim color is Black.
–Fog will be received if Fog or Snow plastic trim is ordered and knit is not Carbon.
- Reference color chart for applied backing material for upholstered or cleanable upholstery back.

Plastic Trim Color	Lumbar	Arm Caps	Backing Material for Upholstered Back
TR-F Black	TR-F Black	TR-F Black	Tellure, Black 3A-18
TR-7 Fog	TR-7 Fog*	TR-7 Fog	Tellure, Goose 3A-54
TR-UFM Snow	TR-7 Fog*	TR-7 Fog	Tellure, Goose 3A-54

*If knit is Carbon, lumbar will be Black.

Plastic Trim Color	Lumbar	Arm Caps	Backing Material for Cleanable Upholstered Back
TR-F Black	TR-F Black	TR-F Black	Wellington, Black XJ-BL
TR-7 Fog	TR-7 Fog*	TR-7 Fog	Wellington, Steel XJ-SL
TR-UFM Snow	TR-7 Fog*	TR-7 Fog	Wellington, Steel XJ-SL

*If knit is Carbon, lumbar will be Black.

Description	Number			Fabric Grade								Leather Grade A	Leather Grade B
	1	2	3	A	B	C	D	E	F	G	H		
Knit Back, No Lumbar Adjustment													
Back Lock w/Fixed Seat	SJTC-	0-001X	A	\$1082.46	\$1117.51	\$1155.08	\$1172.63	\$1187.63	\$1220.20	\$1250.25	\$1330.39	\$1401.75	\$1558.28
Back Lock w/Seat Depth Adjustment	SJTC-	0-001A	A	1104.73	1139.78	1177.35	1194.90	1209.90	1242.47	1272.52	1352.66	1424.02	1580.55
Upholstered Back, No Lumbar Adjustment													
Back Lock w/Fixed Seat	SJTC-	-001X	A	\$1199.15	\$1269.25	\$1344.39	\$1379.49	\$1409.49	\$1474.63	\$1534.73	\$1695.01	\$1837.73	\$2150.79
Back Lock w/Seat Depth Adjustment	SJTC-	-001A	A	1221.42	1291.52	1366.66	1401.76	1431.76	1496.90	1557.00	1717.28	1860.00	2173.06
Knit Back, Lumbar Adjustment													
Back Lock w/Fixed Seat	SJTC-	0-011X	A	\$1135.89	\$1170.94	\$1208.51	\$1226.06	\$1241.06	\$1273.63	\$1303.68	\$1383.82	\$1455.18	\$1611.71
Back Lock w/Seat Depth Adjustment	SJTC-	0-011A	A	1158.16	1193.21	1230.78	1248.33	1263.33	1295.90	1325.95	1406.09	1477.45	1633.98
Upholstered Back, Lumbar Adjustment													
Back Lock w/Fixed Seat	SJTC-	-011X	A	\$1252.58	\$1322.68	\$1397.82	\$1432.92	\$1462.92	\$1528.06	\$1588.16	\$1748.44	\$1891.16	\$2204.22
Back Lock w/Seat Depth Adjustment	SJTC-	-011A	A	1274.85	1344.95	1420.09	1455.19	1485.19	1550.33	1610.43	1770.71	1913.43	2226.49

The following options require modification of the product number.

- Stain Repellent (Fabric seat only)
- Fully Cleanable Back

To specify, add **P** to the end of the product number and add \$38.96 list; **Example:** SJTC-20-001X5AP

To specify, change the 6th digit to **C** and add \$30.60 list to upholstered back list price; **Example:** SJTC-3C-001X5A

Note: Inner back must be Faux Leather to have a fully cleanable back.

Soji

Task Stool without Arms — Aluminum Base



SJTC-001X
SJTC-001A

Dimensions

- *SH: 22"-29.5"
(559mm-749mm)
- H: 44.6"-52.5"
(1133mm-1334mm)
- D: 27"(686mm)
- W: 28"(711mm)
- *SW: 20"(508mm)
- *SD: 16.25"-18.75"
(413mm-476mm)

* All measurements taken with the BIFMA chair measuring device.

Features

- Back: Knit or upholstered.
- Seat: Standard upholstered foam covered in leather, fabric or faux leather. Available as a fixed seat or with seat depth adjustment (2.5"(64mm) range).
- Base: Aluminum five-star base.
- Lumbar: Available with optional lumbar support with 3.5"(89mm) adjustment.
- Mechanism: Synchronized tilt; standard tilt tension adjustment.
- Height adjustment: Standard pneumatic.
- Back Lock: Standard single position upright back lock.
- Casters: Hard casters in black or two-tone grey; Soft casters black only.
- COM yardage/COL square footage: (Seat only) 0.62/5.6

Specification Tips

- Ships standard assembled.
- Lumbar color defaults based on chair attributes and is available in Black or Fog only.
 - Black will be received if Carbon knit is ordered or plastic trim color is Black.
 - Fog will be received if Fog or Snow plastic trim is ordered and knit is not Carbon.
- Reference color chart for applied backing material for upholstered or cleanable upholstery back.

To Order, Specify:

- 1) Product number, including;

1 Seat Upholstery:

- 1 Leather
- 2 Fabric
- 3 Faux Leather

2 Back Upholstery:

- 0 Knit
- 1 Leather
- 2 Fabric
- 3 Faux Leather

3 Caster Option: Standard Base

- 1 Std. Base Hard Casters (Black)
- 2 Std. Base Soft Casters (Black), add **\$45.00** to list
- T Std. Base Hard Two-Tone Casters (Grey)

- 2) Seat surface material and color.
- 3) Back surface material and color.
- 4) Plastic trim color (frame and arm uprights).
 - TR-F Black
 - TR-7 Fog, add **\$72.36** list.
 - TR-UFM Snow, add **\$116.88** list.
- 5) Base color.
 - TR-F Black
 - TR-LE Metallic Silver
 - PM-P Polished Aluminum, add **\$106.08** list.

Plastic Trim Color	Lumbar	Arm Caps	Backing Material for Upholstered Back
TR-F Black	TR-F Black	TR-F Black	Tellure, Black 3A-18
TR-7 Fog	TR-7 Fog*	TR-7 Fog	Tellure, Goose 3A-54
TR-UFM Snow	TR-7 Fog*	TR-7 Fog	Tellure, Goose 3A-54

*If knit is Carbon, lumbar will be Black.

Plastic Trim Color	Lumbar	Arm Caps	Backing Material for Cleanable Upholstered Back
TR-F Black	TR-F Black	TR-F Black	Wellington, Black XJ-BL
TR-7 Fog	TR-7 Fog*	TR-7 Fog	Wellington, Steel XJ-SL
TR-UFM Snow	TR-7 Fog*	TR-7 Fog	Wellington, Steel XJ-SL

*If knit is Carbon, lumbar will be Black.

Description	Number			Fabric Grade								Leather Grade A	Leather Grade B
	1	2	3	A	B	C	D	E	F	G	H		
Knit Back, No Lumbar Adjustment													
Back Lock w/Fixed Seat	SJTC-	0-001X	A	\$1151.64	\$1186.69	\$1224.26	\$1241.81	\$1256.81	\$1289.38	\$1319.43	\$1399.57	\$1470.93	\$1627.46
Back Lock w/Seat Depth Adjustment	SJTC-	0-001A	A	1173.91	1208.96	1246.53	1264.08	1279.08	1311.65	1341.70	1421.84	1493.20	1649.73
Upholstered Back, No Lumbar Adjustment													
Back Lock w/Fixed Seat	SJTC-	-001X	A	\$1268.33	\$1338.43	\$1413.57	\$1448.67	\$1478.67	\$1543.81	\$1603.91	\$1764.19	\$1906.91	\$2219.97
Back Lock w/Seat Depth Adjustment	SJTC-	-001A	A	1290.60	1360.70	1435.84	1470.94	1500.94	1566.08	1626.18	1786.46	1929.18	2242.24
Knit Back, Lumbar Adjustment													
Back Lock w/Fixed Seat	SJTC-	0-011X	A	\$1205.07	\$1240.12	\$1277.69	\$1295.24	\$1310.24	\$1342.81	\$1372.86	\$1453.00	\$1524.36	\$1680.89
Back Lock w/Seat Depth Adjustment	SJTC-	0-011A	A	1227.34	1262.39	1299.96	1317.51	1332.51	1365.08	1395.13	1475.27	1546.63	1703.16
Upholstered Back, Lumbar Adjustment													
Back Lock w/Fixed Seat	SJTC-	-011X	A	\$1321.76	\$1391.86	\$1467.00	\$1502.10	\$1532.10	\$1597.24	\$1657.34	\$1817.62	\$1960.34	\$2273.40
Back Lock w/Seat Depth Adjustment	SJTC-	-011A	A	1344.03	1414.13	1489.27	1524.37	1554.37	1619.51	1679.61	1839.89	1982.61	2295.67

The following options require modification of the product number.

- Stain Repellent (Fabric seat only)
- Fully Cleanable Back

To specify, add **P** to the end of the product number and add **\$38.96** list; **Example:** SJTC-20-001X1AP

To specify, change the 6th digit to **C** and add **\$30.60** list to upholstered back list price; **Example:** SJTC-3C-001X1A

Note: Inner back must be Faux Leather to have a fully cleanable back.

Improv Series

General Specifications

Features and Options (Desk Chairs)

Improv Series desk chairs features:

- Molded-polyfoam, contoured seat and back cushions
- Polypropylene or upholstered outer shell
- Optional steel base with plastic cover
- Hard, dual-wheel casters for carpeted floors (black)
- Optional soft, dual-wheel casters for resilient floor surfaces (black)
- Pneumatic height adjustment
- Optional high arc plastic base
- Loop arms, height-adjustable arms or armless
- Standard hard arm caps or upholstered (fabric, leather, or soft black vinyl) arm caps
- Optional two-stage seat height adjustment and low-position seat height adjustment
- Improv does offer stain repellent and moisture barrier on the fully upholstered back chair models.
- Tilt tension

Improv Series desk chairs meet or exceed all ANSI/BIFMA durability standards for office seating.

Mobility and Adjustability (Task Chairs)

The following features are available on Improv Series desk chair models.



- ▶ Synchronized-tilt (standard)
 - Back and seat recline at a 2:1 ratio with no front seat rise
 - Back tilts backwards 15° from the upright position
 - Seat pan moves downward 7° from the initial position



- ▶ Synchronized-tilt with back-lock
 - Back and seat recline at a 2:1 ratio with no front seat rise
 - Back is lockable in two positions within tilt range
 - Back tilts backwards 15° from the upright position
 - Seat pan moves downward 7° from the initial position
 - Back is lockable in two positions within tilt range, full upright and 5° recline

- ▶ Two-stage seat height adjustment
HAB or 2 stage seat height
(14.3"-21.9"(363mm-556mm))

- ▶ Low-position seat height adjustment
(14"-19"(356mm-483mm))

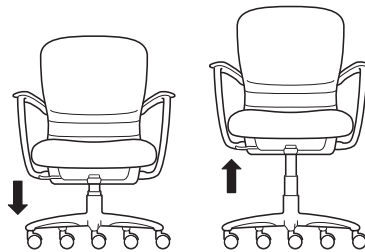

Fully Retracted (.7"(18mm) below standard) Fully Extended (1.9"(48mm) above standard)

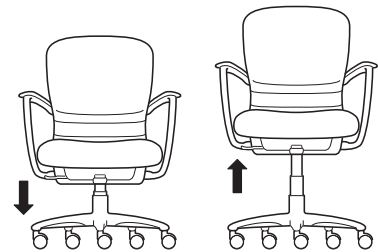

Fully Retracted (1"(25mm) below standard) Fully Extended (1"(25mm) below standard)

- ▶ Optional high arc base

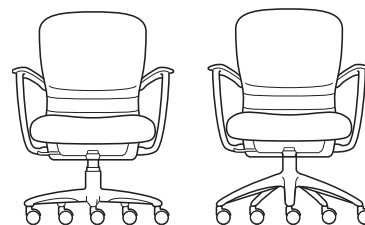

Standard Steel Base High Arc Base
Standard or High Arc Base seat height
(15"-20"(381mm-508mm))

Improv Series

General Specifications

Features and Options (Task Seating)

Improv H.E. chairs features:

- Molded-polyfoam, contoured seat and back cushions
- Separate seat and back cushions
- Polypropylene outer shell
- Five-star base with black casters only
- Hard dual-wheel casters (standard) or soft dual-wheel casters (optional)
- Pneumatic seat height adjustment
- Flipper arms, height-adjustable task arms, task arms, 3-D arms or armless
- Optional two-stage seat height adjustment or low-position seat height adjustment
- Optional adjustable air lumbar
- Optional high arc plastic base
- Optional H.E. XL chair for users up to 500 pounds

Mobility and Adjustability (Task Seating)

The following features are available on Improv H.E. chair models (Refer to price page for specific features).



- Synchronized-tilt (standard)
 - Back and seat recline at a 2:1 ratio with no front seat rise
 - Back tilts backward 20° from the upright position
 - Seat pan moves downward 10° from the initial position

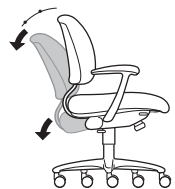

- Synchronized-tilt with back-lock
 - Back and seat recline at a 2:1 ratio with no front seat rise
 - Back is lockable in two positions within tilt range
 - Back tilts backward 20° from the upright position
 - Seat pan moves downward 10° from the initial position



- Forward-tilt
 - Both chair back and seat pan are lockable in three forward positions (1°, 3°, and 5°)

- Adjustable Air Lumbar (H.E. only)
 - Back lumbar has up to 1.5"(38mm) of in/out deflection.



- Seat pan and arms slide horizontally within a 3"(76mm) range

- Two-stage seat height adjustment

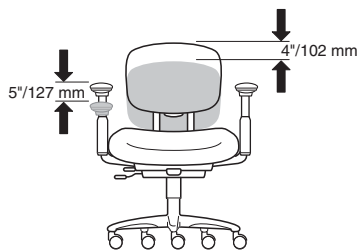

- Back adjusts vertically within a 4"(102mm) range (H.E. only)
- Flipper arms adjust vertically within a 5"(127mm) range

- Low-position seat height adjustment

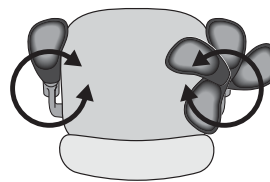

- Flipper arms rotate 360°

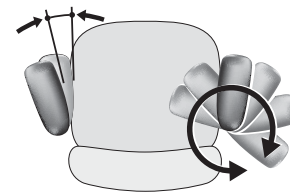

- 3D arms adjust vertically within a 4"(102mm) range and rotate 360°.

- Adjustable Air Lumbar (H.E. only)

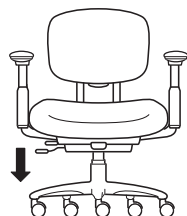

Fully Retracted
(.7"(18mm) below standard)

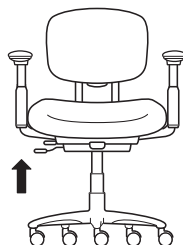

Full Extended
(1.9"(48mm) above standard)

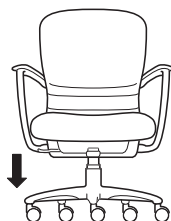

Fully Retracted
(1"(25mm) below standard)

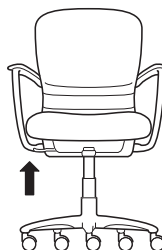

Fully Extended
(1"(25mm) below standard)



- Back lumbar has up to 1.5"(38mm) of in/out deflection.

Improv Series

General Specifications

**Features and Options
(Leg-Base and Sled-Base Chairs)**

Improv Series leg-base and sled-base models feature

- 14-gauge elliptical steel tubing legs
- 14-gauge steel side and front stretchers (with arms, tablet and chairs with casters)
- 11-gauge steel front stretchers (without arms)
- Molded polyurethane seat and back foam
- Optional wood back
- Polypropylene or upholstered outer back shell, or full wood back
- High-density polyethylene floor glides (leg-base models)
- Leg base models available with caster option
- Glass-filled nylon sled-base runners with high-density polyethylene floor glides (sled-base models)
- Powder coated frame
- Ganging device option
- Leg-base models with arms stack 6-high (44"(1118mm)) on the floor and 10-high (62"(1575mm)) on the stacking dolly
- Leg-base armless models stack 6-high (44"(1118mm)) on the floor and 10-high (58"(1473mm)) on the stacking dolly
- Leg-base models with casters stack 5-high (42"(1067mm)) on the floor and 6-high (50"(1270mm)) on the stacking dolly
- Wood back model has same stacking capabilities as the leg-base models

Arm chair models feature:

- Glass reinforced polypropylene arms

Armless models feature:

- High-density polyethylene top caps on exposed legs

Tablet arm models feature:

- Right- or left-hand flip-up tablet arm
- 11"(279mm) or 14"(356mm) tablet arms
- Plywood core with high-pressure laminate surface and clear lacquered edge

All Improv table models feature:

- 1"(25mm)-thick particle board core top with laminate or veneer finished surface
- Bullnose PVC or chamfered hardwood edges
- 14-gauge oval steel tube legs
- 0.75"(19mm) diameter steel stretchers
- High-density polyethylene floor glides
- High-density polyethylene leg top caps

Improv series chairs meet or exceed ANSI/BIFMA durability standards for office seating.

Improv Series

General Specifications

Shipping Weights (Leg-Base and Sled-Base Chairs)	<p>The following weights include packaging materials</p> <ul style="list-style-type: none"> • All leg-base and sled-base chairs 25 lbs. per chair/9.6 cubic ft. (up to 3 chairs per carton) • 20"(508mm) diameter tables 19 lbs./5.3 cubic ft. • 24" x 48"(610mm x 1219mm) oval tables 35 lbs./11 cubic ft. • Chairs without tablet arms are packaged three (3) per carton • Chairs with tablet arms are packaged two (2) per carton • Chairs with leather seats are packaged one (1) per carton <p>NOTE: Models with casters: add one (1) pound per chair</p>
Features and Options (Stools)	<p>All Improv Series stools feature</p> <ul style="list-style-type: none"> • 14-gauge elliptical steel tubing legs • 14-gauge steel side and front stretchers • 14-gauge steel foot rest with lightly textured protective nylon cover • Molded polyurethane seat foam, 1.375"(35mm) thick • Molded polyurethane back foam, 0.875"(22mm) thick • Optional wood back • Polypropylene (0.75"(19mm)) or upholstered (1.25"(32mm)) seat and back shell • High-density polyethylene floor glides • Glass reinforced polypropylene arms or high-density polyethylene top caps on exposed legs • Powder coated frame
Shipping Weights (Stools)	<p>The following weights do not include packaging materials.</p> <p>Stool with arms: 30 lbs./13.608k Stool without arms: 27 lbs./12.247k</p>
COM & COL General Information	<p>To order a COM fabric (Customer's Own Material), contact the Haworth Inquiry Center (1.800.426.8562), your local Haworth dealer, or go to haworth.com/surfaces to find out if the COM you have selected has already been tested and approved. The surface collection site also has information on the Haworth alliance program with Carnegie, Luna Textiles, and Maharam as well as our industry-leading Pre-Approved COM program.</p> <p>COM fabrics are placed into Grades based on the cost per linear yard. If a fabric's cost exceeds the range of our highest Grade it will be noted as Non-Graded. The product will be priced at Grade A; the COM fabric costs will appear as a separate line item. The fabric charge will be Haworth's purchase cost plus a 4% administrative fee (based on the cost of the fabric). Yardage calculations will include any applicable fabric repeat.</p> <p>COM Leather products will be priced at a leather Grade A; COL costs will appear as a separate line item. The leather costs will be Haworth's purchase cost plus a 4% administrative fee (based on the cost of the leather).</p>
Environmental Factors	<p><u>Material Off Gassing</u></p> <p>In an effort to ensure air quality standards, all Improv parts suppliers are required to provide Material Data Sheets and/or other documentation, verifying that their products do not emit volatile organic compounds (VOCs). In addition, the powder-coat paint process used in the manufacturing of Improv seating is free of VOCs. Our manufacturing processes have also eliminated all use of chlorofluorocarbons (CFCs) and ozone depleting chemicals (ODCs) in the chair's construction.</p> <p><u>Recycling</u></p> <p>All fabric scraps are recycled, reducing the amount of material sent to landfills, and all chair components disassemble easily to increase the potential for recycling. In addition, all thermo-plastic parts are 100% reprocessible, and all raw materials used in its manufacturing can be recycled at the end of the useful life of the product. Recyclable parts are identified with the recycle symbol where practical.</p>

Improv Series

General Specifications

General Guidelines for Product Specification

Improv Series seating specification numbers are based on an alpha-numeric logic that identifies a product by model and certain characteristics.

For example, a product number that reads **M221-2241** identifies the product as an Improv high-back chair with seamless upholstered outer shell, pneumatic seat height adjustment, upholstered arms, back-lock, and hard dual-wheel casters.

The alpha-numeric logic for this model complete with fabric and finish codes is shown below:

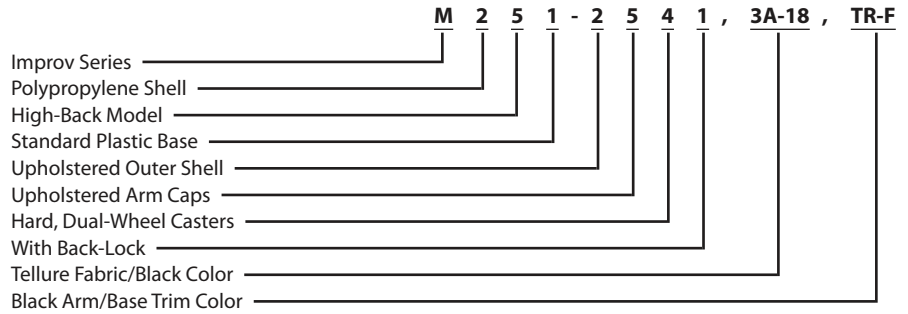

A ninth-digit suffix of the product number will indicate functional option, such as -F for CAL 133 option.

There are exceptions to this logic; therefore, always refer to the price charts for product numbers rather than attempting to construct them. Product number modification instructions for additional options appear in footnoted copy for each applicable model.

Beyond the printed product number, fabric and finish codes are required to complete an order specification. To communicate your order clearly, list the product number and fabric/finish codes in the sequence outlined on each price page.

Finishes and Fabrics

A complete listing of finishes and fabrics for Improv Series desk chairs can be found in the back of the price list.

Improv Series

Improv H.E. XL Chair with Task Arms



M271-1442

Dimensions

- *SH: 16" - 20.5"
(406mm - 521mm)
- H: 36.5" - 45"
(957mm - 1143mm)
- D: 23.5" - 26.5"
(597mm - 673mm)
- W: 30"(762mm)
- *SW: 23.75"(603mm)
- *SD: 19"(483mm)
- *AH: 9.6"(244mm)

* All measurements taken with the BIFMA chair measuring device.

Features

- Accommodates up to 500 pounds.
- Outer Shells: Polypropylene.
- Arms: Standard, upholstered fabric or soft black vinyl arm caps.
- Casters: Standard with hard casters.
- Mechanism: Swivel with synchronized-tilt.
- Height Adjustment: Pneumatic.
- Optional Back-Lock: Lockable in two positions.
- Optional Forward Tilt: Lockable in 3 positions.
- Tilt tension.
- Optional Adjustable Air Lumbar additional 1.5"(38mm) of lumbar support.
- COM yardage / COL square footage: Polypropylene shell: 2.41/51

To Order, Specify:

- 1) Product number.
- 2) Fabric surface and color. (NOTE: For leather upholstery, see below.)
- 3) Trim color for shell, arms and base.

Shells	Arms/Caps	Number	Fabric Grade								Leather Grade A	Leather Grade B
			A	B	C	D	E	F	G	H		
Pneumatic Height Adjustment												
Polypropylene	Standard	M271-1442	\$2790.78	\$2887.44	\$2988.70	\$3039.32	\$3083.78	\$3172.84	\$3254.10	\$3479.66	\$3636.10	\$3867.68
	Upholstered	M271-1542	2856.76	2953.42	3054.68	3105.30	3149.76	3238.82	3320.08	3545.64	3702.08	3933.66
	Soft Black Vinyl	M271-1642	2856.76	2953.42	3054.68	3105.30	3149.76	3238.82	3320.08	3545.64	3702.08	3933.66
Pneumatic Height Adjustment/Back-Lock												
Polypropylene	Standard	M271-1441	\$2856.76	\$2953.42	\$3054.68	\$3105.30	\$3149.76	\$3238.82	\$3320.08	\$3545.64	\$3702.08	\$3933.66
	Upholstered	M271-1541	2922.74	3019.40	3120.66	3171.28	3215.74	3304.80	3386.06	3611.62	3768.06	3999.64
	Soft Black Vinyl	M271-1641	2922.74	3019.40	3120.66	3171.28	3215.74	3304.80	3386.06	3611.62	3768.06	3999.64
Pneumatic Height Adjustment/Forward-Tilt												
Polypropylene	Standard	M281-1442	\$2855.21	\$2951.87	\$3053.13	\$3103.75	\$3148.21	\$3237.27	\$3318.53	\$3544.09	\$3700.53	\$3932.11
	Upholstered	M281-1542	2921.19	3017.85	3119.11	3169.73	3214.19	3303.25	3384.51	3610.07	3766.51	3998.09
	Soft Black Vinyl	M281-1642	2921.19	3017.85	3119.11	3169.73	3214.19	3303.25	3384.51	3610.07	3766.51	3998.09
Pneumatic Height Adjustment with Adjustable Air Lumbar												
Polypropylene	Standard	M271-1444	\$2950.35	\$3047.01	\$3148.27	\$3198.89	\$3243.35	\$3332.41	\$3413.67	\$3639.23	\$3795.67	\$4027.25
	Upholstered	M271-1544	3016.33	3112.99	3214.25	3264.87	3309.33	3398.39	3479.65	3705.21	3861.65	4093.23
	Soft Black Vinyl	M271-1644	3016.33	3112.99	3214.25	3264.87	3309.33	3398.39	3479.65	3705.21	3861.65	4093.23
Pneumatic Height Adjustment/Back-Lock with Adjustable Air Lumbar												
Polypropylene	Standard	M271-1443	\$3016.33	\$3112.99	\$3214.25	\$3264.87	\$3309.33	\$3398.39	\$3479.65	\$3705.21	\$3861.65	\$4093.23
	Upholstered	M271-1543	3082.31	3178.97	3280.23	3330.85	3375.31	3464.37	3545.63	3771.19	3927.63	4159.21
	Soft Black Vinyl	M271-1643	3082.31	3178.97	3280.23	3330.85	3375.31	3464.37	3545.63	3771.19	3927.63	4159.21
Pneumatic Height Adjustment/Forward-Tilt with Adjustable Air Lumbar												
Polypropylene	Standard	M281-1444	\$3014.78	\$3111.44	\$3212.70	\$3263.32	\$3307.78	\$3396.84	\$3478.10	\$3703.66	\$3860.10	\$4091.68
	Upholstered	M281-1544	3080.76	3177.42	3278.68	3329.30	3373.76	3462.82	3544.08	3769.64	3926.08	4157.66
	Soft Black Vinyl	M281-1644	3080.76	3177.42	3278.68	3329.30	3373.76	3462.82	3544.08	3769.64	3926.08	4157.66

The following options require modification of the product number.

- Faux Leather upholstery
- Leather upholstery
- Stain repellent

To specify, change the 2nd digit from a 2 to a 3; **Example:** M371-1542

To specify, change the 2nd digit from a 2 to a 1; **Example:** M171-1542

To specify, add -P to the end of the product number; **Example:** M271-1442-P (add \$49.10 list)

NOTE: For available fabrics, refer to surfaces.haworth.com.

Improv Series

Improv H.E. XL Chair with Height Adjustable Task Arms



M271-1742

Dimensions

- *SH: 16" - 20.5"
(406mm - 521mm)
- H: 36.5" - 45"
(957mm - 1143mm)
- D: 23.5" - 26.5"
(597mm - 673mm)
- W: 30"(762mm)
- *SW: 23.75"(603mm)
- *SD: 19"(483mm)
- *AH: 6.9" - 10.8"
(175mm - 274mm)

* All measurements taken with the BIFMA chair measuring device.

Features

- Accommodates up to 500 pounds.
- Outer Shells: Polypropylene.
- Arms: Standard, upholstered fabric or soft black vinyl arm caps.
- Arm Adjustment Controls: Fingertip activation.
- Arm Adjustment: 4"(102mm) height adjustment.
- Casters: Standard with hard casters.
- Mechanism: Swivel with synchronized-tilt.
- Height Adjustment: Pneumatic.
- Optional Back-Lock: Lockable in two positions.
- Optional Forward Tilt: Lockable in 3 positions.
- Tilt tension
- Optional Adjustable Air Lumbar: additional 1.5"(38mm) of lumbar support.
- COM yardage / COL square footage: Polypropylene shell: 2.41/51

To Order, Specify

- 1) Product number.
- 2) Fabric surface and color. (For leather upholstery, see following page.)
- 3) Tilt angle for shell, arms and base.

Shells	Arms/Caps	Number	Fabric Grade		C	D	E	F	G	H	Leather Grade A	Leather Grade B
			A	B								
Pneumatic Height Adjustment												
Polypropylene	Standard	M271-1742	\$2928.85	\$3025.51	\$3126.77	\$3177.39	\$3221.85	\$3310.91	\$3392.17	\$3617.73	\$3774.17	\$4005.75
	Upholstered	M271-1842	2994.83	3091.46	3192.75	3243.37	3287.83	3376.89	3458.15	3683.71	3840.15	4071.73
	Soft Black Vinyl	M271-1942	2994.83	3091.46	3192.75	3243.37	3287.83	3376.89	3458.15	3683.71	3840.15	4071.73
Pneumatic Height Adjustment/Back-Lock												
Polypropylene	Standard	M271-1741	\$2994.83	\$3091.46	\$3192.75	\$3243.37	\$3287.83	\$3376.89	\$3458.15	\$3683.71	\$3840.15	\$4071.73
	Upholstered	M271-1841	3060.77	3157.40	3258.73	3309.35	3353.81	3442.87	3524.13	3749.69	3906.13	4137.71
	Soft Black Vinyl	M271-1941	3060.77	3157.40	3258.73	3309.35	3353.81	3442.87	3524.13	3749.69	3906.13	4137.71
Pneumatic Height Adjustment/Forward-Tilt												
Polypropylene	Standard	M281-1742	\$2928.85	\$3089.94	\$3191.20	\$3241.82	\$3286.28	\$3375.34	\$3456.60	\$3682.16	\$3838.60	\$4070.18
	Upholstered	M281-1842	3051.28	3155.92	3257.18	3307.80	3352.26	3441.32	3522.58	3748.14	3904.58	4136.16
	Soft Black Vinyl	M281-1942	3051.28	3155.92	3257.18	3307.80	3352.26	3441.32	3522.58	3748.14	3904.58	4136.16
Pneumatic Height Adjustment with Adjustable Air Lumbar												
Polypropylene	Standard	M271-1743	\$3088.42	\$3185.08	\$3286.34	\$3336.96	\$3381.42	\$3470.48	\$3551.74	\$3777.30	\$3933.74	\$4165.32
	Upholstered	M271-1843	3154.40	3251.06	3352.32	3402.94	3447.40	3536.46	3617.72	3843.28	3999.72	4231.30
	Soft Black Vinyl	M271-1943	3154.40	3251.06	3352.32	3402.94	3447.40	3536.46	3617.72	3843.28	3999.72	4231.30
Pneumatic Height Adjustment/Back-Lock with Adjustable Air Lumbar												
Polypropylene	Standard	M271-1743	\$3154.40	\$3251.06	\$3352.32	\$3402.94	\$3447.40	\$3536.46	\$3617.72	\$3843.28	\$3999.72	\$4231.30
	Upholstered	M271-1843	3220.38	3317.04	3418.30	3468.92	3513.38	3602.44	3683.70	3909.26	4065.70	4297.28
	Soft Black Vinyl	M271-1943	3220.38	3317.04	3418.30	3468.92	3513.38	3602.44	3683.70	3909.26	4065.70	4297.28
Pneumatic Height Adjustment/Forward-Tilt with Adjustable Air Lumbar												
Polypropylene	Standard	M281-1744	\$3152.85	\$3249.51	\$3350.77	\$3401.39	\$3445.85	\$3534.91	\$3616.17	\$3841.73	\$3998.17	\$4229.75
	Upholstered	M281-1844	3218.83	3315.49	3416.75	3467.37	3511.83	3600.89	3682.15	3907.71	4064.15	4295.73
	Soft Black Vinyl	M281-1944	3218.83	3315.49	3416.75	3467.37	3511.83	3600.89	3682.15	3907.71	4064.15	4295.73

The following options require modification of the product number.

- Faux Leather upholstery
- Leather upholstery
- Stain repellent

To specify, change the 2nd digit from a 2 to a 3; **Example:** M371-1842

To specify, change the 2nd digit from a 2 to a 1; **Example:** M171-1842

To specify, add -P to the end of the product number; **Example:** M271-1744-P (add \$49.10 list)

NOTE: For available fabrics, refer to surfaces.haworth.com.

Improv Series

Improv H.E. XL Chair with Flipper Arms



M271-1H42

Dimensions

- *SH: 16" - 20.5"
(406mm - 521mm)
- H: 36.5" - 45"
(957mm - 1143mm)
- D: 23.5" - 26.5"
(597mm - 673mm)
- W: 30"(762mm)
- *SW: 23.75"(603mm)
- *SD: 19"(483mm)
- *AH: 6.2" - 11.1"
(157mm-282mm)

* All measurements taken with the BIFMA chair measuring device.

Features

- Accommodates up to 500 pounds.
- Outer Shells: Polypropylene.
- Arms: Standard, upholstered fabric or black vinyl gel arm caps.
- Arm Adjustment Controls: Fingertip activation.
- Arm Adjustment: 5"(127mm) height adjustment.
- Arm Pad Rotation: 360°
- Casters: Standard with hard casters.
- Mechanism: Swivel with synchronized-tilt.
- Height Adjustment: Pneumatic.
- Optional Back-Lock: Lockable in two positions.
- Optional Forward Tilt: Lockable in 3 positions.
- Tilt tension.
- Optional Adjustable Air Lumbar additional 1.5"(38mm) of lumbar support.
- COM yardage / COL square footage: Polypropylene shell: 2.41/51

To Order, Specify:

- 1) Product number.
- 2) Fabric surface and color. (NOTE: For leather upholstery, see below.)
- 3) Trim color for shell, arms and base.

Shells	Arms/Caps	Number	Fabric Grade		C	D	E	F	G	H	Leather Grade A	Leather Grade B
			A	B								
Pneumatic Height Adjustment												
Polypropylene	Standard	M271-1H42	\$3211.15	\$3307.81	\$3409.07	\$3459.69	\$3504.15	\$3593.21	\$3674.47	\$3900.03	\$4056.47	\$4288.05
	Vinyl Gel	M271-1G42	\$295.53	\$392.19	\$3493.45	\$3544.07	\$3588.53	\$3677.59	\$3758.85	\$3984.41	\$4140.85	\$4372.43
	Upholstered	M271-1U42	\$355.36	\$452.02	\$3553.28	\$3603.90	\$3648.36	\$3737.42	\$3818.68	\$4044.24	\$4200.68	\$4432.26
Pneumatic Height Adjustment/Back-Lock												
Polypropylene	Standard	M271-1H41	\$3277.13	\$3373.79	\$3475.05	\$3525.67	\$3570.13	\$3659.19	\$3740.45	\$3966.01	\$4122.45	\$4354.03
	Vinyl Gel	M271-1G41	\$361.51	\$458.17	\$3559.43	\$3610.05	\$3654.51	\$3743.57	\$3824.83	\$4050.39	\$4206.83	\$4438.41
	Upholstered	M271-1U41	\$421.34	\$518.00	\$3619.26	\$3669.88	\$3714.34	\$3803.40	\$3884.66	\$4110.22	\$4266.66	\$4498.24
Pneumatic Height Adjustment/Forward-Tilt												
Polypropylene	Standard	M281-1H42	\$3275.58	\$3372.24	\$3473.50	\$3524.12	\$3568.58	\$3657.64	\$3738.90	\$3964.46	\$4120.90	\$4352.48
	Vinyl Gel	M281-1G42	\$359.96	\$456.62	\$3557.88	\$3608.50	\$3652.96	\$3742.02	\$3823.28	\$4048.84	\$4205.28	\$4436.86
	Upholstered	M281-1U42	\$419.79	\$516.45	\$3617.71	\$3668.33	\$3712.79	\$3801.85	\$3883.11	\$4108.67	\$4265.11	\$4496.69
Pneumatic Height Adjustment with Adjustable Air Lumbar												
Polypropylene	Standard	M271-1H44	\$3370.72	\$3467.38	\$3568.64	\$3619.26	\$3663.72	\$3752.78	\$3834.04	\$4059.60	\$4216.04	\$4447.62
	Vinyl Gel	M271-1G44	\$455.10	\$551.76	\$3653.02	\$3703.64	\$3748.10	\$3837.16	\$3918.42	\$4143.98	\$4300.42	\$4532.00
	Upholstered	M271-1U44	\$514.93	\$611.59	\$3712.85	\$3763.47	\$3807.93	\$3896.99	\$3978.25	\$4203.81	\$4360.25	\$4591.83
Pneumatic Height Adjustment/Back-Lock with Adjustable Air Lumbar												
Polypropylene	Standard	M271-1H43	\$3436.70	\$3533.36	\$3634.62	\$3685.24	\$3729.70	\$3818.76	\$3900.02	\$4125.58	\$4282.02	\$4513.60
	Vinyl Gel	M271-1G43	\$521.08	\$617.74	\$3719.00	\$3769.62	\$3814.08	\$3903.14	\$3984.40	\$4209.96	\$4366.40	\$4597.98
	Upholstered	M271-1U43	\$580.91	\$677.57	\$3778.83	\$3829.45	\$3873.91	\$3962.97	\$4044.23	\$4269.79	\$4426.23	\$4657.81
Pneumatic Height Adjustment/Forward-Tilt with Adjustable Air Lumbar												
Polypropylene	Standard	M281-1H44	\$3435.15	\$3531.81	\$3633.07	\$3683.69	\$3728.15	\$3817.21	\$3898.47	\$4124.03	\$4280.47	\$4512.05
	Vinyl Gel	M281-1G44	\$519.53	\$616.19	\$3717.45	\$3768.07	\$3812.53	\$3901.59	\$3982.85	\$4208.41	\$4364.85	\$4596.43
	Upholstered	M281-1U44	\$579.36	\$676.02	\$3777.28	\$3827.90	\$3872.36	\$3961.42	\$4042.68	\$4268.24	\$4424.68	\$4656.26

The following options require modification of the product number.

- Faux Leather upholstery
- Leather upholstery
- Stain repellent

To specify, change the 2nd digit from a 2 to a 3; **Example:** M371-1H42
 To specify, change the 2nd digit from a 2 to a 1; **Example:** M171-1H42
 To specify, add -P to the end of the product number; **Example:** M271-1H44-P (add \$49.10 list)

NOTE: For available fabrics, refer to surfaces.haworth.com.

Improv Series

Improv H.E. XL Chair without Arms



M271-1042

Dimensions

- *SH: 16" - 20.5"
(406mm - 521mm)
- H: 36.5" - 45"
(957mm-1143mm)
- D: 23.5" - 26.5"
(597mm - 673mm)
- W: 30"(762mm)
- *SW: 23.75"(603mm)
- *SD: 19"(483mm)

* All measurements taken with the BIFMA chair measuring device.

Features

- Accommodates up to 500 pounds.
- Outer Shells: Polypropylene.
- Casters: Standard with hard casters.
- Mechanism: Swivel with synchronized-tilt.
- Height Adjustment: Pneumatic.
- Optional Adjustable Air Lumbar models available: additional 1.5"(38mm) of lumbar support.
- Optional Back-Lock: Lockable in two positions.
- Optional Forward Tilt: Lockable in 3 positions.
- Tilt tension.
- COM yardage / COL square footage: Polypropylene shell: 2.41/51

To Order, Specify:

- 1) Product number.
- 2) Fabric surface and color. (NOTE: For leather upholstery, see below.)
- 3) Trim color for shell and base.

Shells	Number	Fabric Grade								Leather Grade A	Leather Grade B
		A	B	C	D	E	F	G	H		
Pneumatic Height Adjustment											
Polypropylene	M271-1042	\$2661.89	\$2758.55	\$2859.81	\$2910.43	\$2954.89	\$3043.95	\$3125.21	\$3350.77	\$3507.21	\$3738.79
Pneumatic Height Adjustment/Back-Lock											
Polypropylene	M271-1041	\$2727.87	\$2824.53	\$2925.79	\$2976.41	\$3020.87	\$3109.93	\$3191.19	\$3416.75	\$3573.19	\$3804.77
Pneumatic Height Adjustment/Forward-Tilt											
Polypropylene	M281-1042	\$2726.32	\$2822.98	\$2924.24	\$2974.86	\$3019.32	\$3108.38	\$3189.64	\$3415.20	\$3571.64	\$3803.22
Pneumatic Height Adjustment with Adjustable Air Lumbar											
Polypropylene	M271-1044	\$2821.46	\$2918.12	\$3019.38	\$3070.00	\$3114.46	\$3203.52	\$3284.78	\$3510.34	\$3666.78	\$3898.36
Pneumatic Height Adjustment/Back-Lock with Adjustable Air Lumbar											
Polypropylene	M271-1043	\$2887.44	\$2984.10	\$3085.36	\$3135.98	\$3180.44	\$3269.50	\$3350.76	\$3576.32	\$3732.76	\$3964.34
Pneumatic Height Adjustment/Forward-Tilt with Adjustable Air Lumbar											
Polypropylene	M281-1044	\$2885.89	\$2982.55	\$3083.81	\$3134.43	\$3178.89	\$3267.95	\$3349.21	\$3574.77	\$3731.21	\$3962.79

The following options require modification of the product number.

- Faux Leather upholstery
- Leather upholstery
- Stain repellent

- To specify, change the 2nd digit from a 2 to a 3; **Example:** M371-2042
- To specify, change the 2nd digit from a 2 to a 1; **Example:** M171-2042
- To specify, add -P to the end of the product number; **Example:** M271-1042-P (add \$49.10 list)

NOTE: For available fabrics, refer to surfaces.haworth.com.

Improv Series

Improv H.E. High-Back Chair with Task Arms



M251-1442

Dimensions

SH: 16" - 21"
(406mm-533mm)
H: 36.5" - 45"
(957mm - 1143mm)
D: 24" - 27.25"
(610mm - 692mm)
W: 25"(635mm)
*SW: 19.2"(488mm)
*SD: 16" - 19"
(406mm - 483mm)
*AH: 9.6"(244mm)

* All measurements taken with the BIFMA chair measuring device.

Features

- Outer Shells: Polypropylene.
- Arms: Standard, upholstered fabric or soft black vinyl arm caps.
- 3"(76mm) sliding seat pan.
- Casters: Standard with hard casters; or optional soft casters.
- Standard plastic base or optional high arc base.
- Mechanism: Swivel with synchronized-tilt.
- Height Adjustment: Pneumatic, pneumatic with low-position seat height option.
- Optional Back-Lock: Lockable in two positions.
- Optional Forward Tilt: Lockable in 3 positions.
- Tilt tension.
- Optional Adjustable Air Lumbar: additional 1.5"(38mm) of lumbar support.
- COM yardage / COL square footage: Polypropylene shell: 2.13/45

To Order, Specify:

- 1) Product number.
- 2) Fabric surface and color. (NOTE: For leather upholstery, see page 0.)
- 3) Trim color for shell, arms and base.

Shells	Arms/Caps	Number	Fabric Grade		C	D	E	F	G	H	Leather Grade A	Leather Grade B
			A	B								
Pneumatic Height Adjustment												
Polypropylene	Standard	M251-1442	\$1399.22	\$1495.88	\$1597.14	\$1647.76	\$1692.22	\$1781.28	\$1862.54	\$2088.10	\$2244.54	\$2476.12
	Upholstered	M251-1542	1465.20	1561.86	1663.12	1713.74	1758.20	1847.26	1928.52	2154.08	2310.52	2542.10
	Soft Black Vinyl	M251-1642	1465.20	1561.86	1663.12	1713.74	1758.20	1847.26	1928.52	2154.08	2310.52	2542.10
Pneumatic Height Adjustment/Back-Lock												
Polypropylene	Standard	M251-1441	\$1465.20	\$1561.86	\$1663.12	\$1713.74	\$1758.20	\$1847.26	\$1928.52	\$2154.08	\$2310.52	\$2542.10
	Upholstered	M251-1541	1531.18	1627.84	1729.10	1779.72	1824.18	1913.24	1994.50	2220.06	2376.50	2608.08
	Soft Black Vinyl	M251-1641	1531.18	1627.84	1729.10	1779.72	1824.18	1913.24	1994.50	2220.06	2376.50	2608.08
Pneumatic Height Adjustment/Forward-Tilt												
Polypropylene	Standard	M261-1442	\$1463.65	\$1560.31	\$1661.57	\$1712.19	\$1756.65	\$1845.71	\$1926.97	\$2152.53	\$2308.97	\$2540.55
	Upholstered	M261-1542	1529.63	1626.29	1727.55	1778.17	1822.63	1911.69	1992.95	2218.51	2374.95	2606.53
	Soft Black Vinyl	M261-1642	1529.63	1626.29	1727.55	1778.17	1822.63	1911.69	1992.95	2218.51	2374.95	2606.53
Pneumatic Height Adjustment with Adjustable Air Lumbar												
Polypropylene	Standard	M251-1444	\$1558.79	\$1655.45	\$1756.71	\$1807.33	\$1851.79	\$1940.85	\$2022.11	\$2247.67	\$2404.11	\$2635.69
	Upholstered	M251-1544	1624.77	1721.43	1822.69	1873.31	1917.77	2006.83	2088.09	2313.65	2470.09	2701.67
	Soft Black Vinyl	M251-1644	1624.77	1721.43	1822.69	1873.31	1917.77	2006.83	2088.09	2313.65	2470.09	2701.67
Pneumatic Height Adjustment/Back-Lock with Adjustable Air Lumbar												
Polypropylene	Standard	M251-1443	\$1624.77	\$1721.43	\$1822.69	\$1873.31	\$1917.77	\$2006.83	\$2088.09	\$2313.65	\$2470.09	\$2701.67
	Upholstered	M251-1543	1690.75	1787.41	1888.67	1939.29	1983.75	2072.81	2154.07	2379.63	2536.07	2767.65
	Soft Black Vinyl	M251-1643	1690.75	1787.41	1888.67	1939.29	1983.75	2072.81	2154.07	2379.63	2536.07	2767.65
Pneumatic Height Adjustment/Forward-Tilt with Adjustable Air Lumbar												
Polypropylene	Standard	M261-1444	\$1623.22	\$1719.88	\$1821.14	\$1871.76	\$1916.22	\$2005.28	\$2086.54	\$2312.10	\$2468.54	\$2700.12
	Upholstered	M261-1544	1689.20	1785.86	1887.12	1937.74	1982.20	2071.26	2152.52	2378.08	2534.52	2766.10
	Soft Black Vinyl	M261-1644	1689.20	1785.86	1887.12	1937.74	1982.20	2071.26	2152.52	2378.08	2534.52	2766.10

The following options require modification of the product number.

High arc base

~~Steel base - Standard height~~

~~Steel base - Low height~~

Plastic base - Low height

Soft casters

Faux Leather upholstery

Leather upholstery

Stain repellent

To specify, change the 4th digit from a 1 to a 5; **Example:** M255-1442

~~To specify, change the 4th digit from a 1 to a 6; **Example:** M256-1442~~

~~To specify, change the 4th digit from a 1 to a 7; **Example:** M257-1442~~

To specify, change the 4th digit from a 1 to a 4; **Example:** M254-1442

To specify, change the 7th digit from a 4 to a 2; **Example:** M251-1422

To specify, change the 2nd digit from a 2 to a 3; **Example:** M351-1442

To specify, change the 2nd digit from a 2 to a 1; **Example:** M151-1442

To specify, add -P to the end of the product number; **Example:** M251-1444-P (add \$49.10 list)

NOTE: High arc base available in black only.

For available fabrics, refer to surfaces.haworth.com.

Improv Series

Improv H.E. High-Back Chair with Height Adjustable Task Arms



M251-1742

Dimensions

- *SH: 16" - 21"
(406mm - 533mm)
- H: 36.5" - 45"
(957mm - 1143mm)
- D: 24" - 27.25"
(610mm - 692mm)
- W: 25"(635mm)
- *SW: 19.2"(488mm)
- *SD: 16" - 19"
(406mm - 483mm)
- *AH: 6.9" - 10.8"
(175mm - 274mm)

* All measurements taken with the BIFMA chair measuring device.

Features

- Outer Shells: Polypropylene.
- Arms: Standard, upholstered fabric or soft black vinyl arm caps.
- Arm Adjustment Controls: Fingertip activation.
- Arm Adjustment: 4"(102mm) height adjustment.
- 3"(76mm) sliding seat pan.
- Casters: Standard with hard casters; or optional soft casters.
- Standard plastic base or optional high arc, or steel base.
- Mechanism: Swivel with synchronized-tilt.
- Height Adjustment: Pneumatic, pneumatic with low-position seat height option.
- Optional Back-Lock: Lockable in two positions.
- Optional Forward Tilt: Lockable in 3 positions.
- Tilt tension.
- Optional Adjustable Air Lumbar: additional 1.5"(38mm) of lumbar support.
- COM yardage / COL square footage: Polypropylene shell: 2.13/45

To Order, Specify:

- 1) Product number.
- 2) Fabric surface and color. (NOTE: For leather upholstery, see page 0.)
- 3) Trim color for shells, arms and base.

Shells	Arms/Caps	Number	Fabric Grade								Leather Grade A	Leather Grade B
			A	B	C	D	E	F	G	H		
Pneumatic Height Adjustment												
Polypropylene	Standard	M251-1742	\$1537.29	\$1633.95	\$1719.21	\$1799.83	\$1830.29	\$1919.35	\$2000.61	\$2226.17	\$2382.61	\$2614.19
	Upholstered	M251-1842	1603.27	1699.93	1801.19	1851.81	1896.27	1985.33	2066.59	2292.15	2448.59	2680.17
	Soft Black Vinyl	M251-1942	1603.27	1699.93	1801.19	1851.81	1896.27	1985.33	2066.59	2292.15	2448.59	2680.17
Pneumatic Height Adjustment/Back-Lock												
Polypropylene	Standard	M251-1741	\$1603.27	\$1699.93	\$1801.19	\$1851.81	\$1896.27	\$1985.33	\$2066.59	\$2292.15	\$2448.59	\$2680.17
	Upholstered	M251-1841	1669.25	1765.91	1867.17	1917.79	1962.25	2051.31	2132.57	2358.13	2514.57	2746.15
	Soft Black Vinyl	M251-1941	1669.25	1765.91	1867.17	1917.79	1962.25	2051.31	2132.57	2358.13	2514.57	2746.15
Pneumatic Height Adjustment/Forward-Tilt												
Polypropylene	Standard	M261-1742	\$1667.70	\$1764.36	\$1865.62	\$1916.24	\$1960.70	\$1983.78	\$2065.04	\$2290.60	\$2447.04	\$2678.62
	Upholstered	M261-1842	1667.70	1764.36	1865.62	1916.24	1960.70	2049.76	2131.02	2356.58	2513.02	2744.60
	Soft Black Vinyl	M261-1942	1667.70	1764.36	1865.62	1916.24	1960.70	2049.76	2131.02	2356.58	2513.02	2744.60
Pneumatic Height Adjustment with Adjustable Air Lumbar												
Polypropylene	Standard	M251-1744	\$1696.86	\$1793.52	\$1894.78	\$1945.40	\$1989.86	\$2078.92	\$2160.18	\$2385.74	\$2542.18	\$2773.76
	Upholstered	M251-1844	1762.84	1859.50	1960.76	2011.38	2055.84	2144.90	2226.16	2451.72	2608.16	2839.74
	Soft Black Vinyl	M251-1944	1762.84	1859.50	1960.76	2011.38	2055.84	2144.90	2226.16	2451.72	2608.16	2839.74
Pneumatic Height Adjustment/Back-Lock with Adjustable Air Lumbar												
Polypropylene	Standard	M251-1743	\$1762.84	\$1859.50	\$1960.76	\$2011.38	\$2055.84	\$2144.90	\$2226.16	\$2451.72	\$2608.16	\$2839.74
	Upholstered	M251-1843	1828.82	1925.48	2026.74	2077.36	2121.82	2210.88	2292.14	2517.70	2674.14	2905.72
	Soft Black Vinyl	M251-1943	1828.82	1925.48	2026.74	2077.36	2121.82	2210.88	2292.14	2517.70	2674.14	2905.72
Pneumatic Height Adjustment/Forward-Tilt with Adjustable Air Lumbar												
Polypropylene	Standard	M261-1744	\$1761.29	\$1857.95	\$1959.21	\$2009.83	\$2054.29	\$2143.35	\$2224.61	\$2450.17	\$2606.61	\$2838.19
	Upholstered	M261-1844	1827.27	1923.93	2025.19	2075.81	2120.27	2209.33	2290.59	2516.15	2672.59	2904.17
	Soft Black Vinyl	M261-1944	1827.27	1923.93	2025.19	2075.81	2120.27	2209.33	2290.59	2516.15	2672.59	2904.17

The following options require modification of the product number.

- High arc base
- Steel base - Standard height
- Steel base - Low height
- Plastic base - Low height
- Soft casters
- Faux Leather upholstery
- Leather upholstery
- Stain repellent

- To specify, change the 4th digit from a 1 to a 5; **Example:** M255-1742
- To specify, change the 4th digit from a 1 to a 6; **Example:** M256-1742
- To specify, change the 4th digit from a 1 to a 7; **Example:** M257-1742
- To specify, change the 4th digit from a 1 to a 4; **Example:** M254-1742
- To specify, change the 7th digit from a 4 to a 2; **Example:** M251-1722
- To specify, change the 2nd digit from a 2 to a 3; **Example:** M351-1742
- To specify, change the 2nd digit from a 2 to a 1; **Example:** M151-1742
- To specify, add -P to the end of the product number; **Example:** M251-1744-P (add \$49.10 list)

NOTE: High arc base available in black only.

For available fabrics, refer to surfaces.haworth.com.

Improv Series

Improv H.E. High-Back Chair with Flipper Arms



M251-1H42

NOTE:
M261-1G42 offers the best value package of options for this model.

Dimensions

- *SH: 16" - 21"
(406mm - 533mm)
- H: 36.5" - 45"
(957mm-1143mm)
- D: 24" - 27.25"
(610mm - 692mm)
- W: 26.5"(673mm)
- *SW: 19.2"(488mm)
- *SD: 16" - 19"
(406mm - 483mm)
- *AH: 6.2" - 11.3"
(157mm-287mm)

* All measurements taken with the BIFMA chair measuring device.

Features

- Outer Shells: Polypropylene.
- Arms: Standard, upholstered fabric or black vinyl gel arm caps.
- Arm Adjustment Controls: Fingertip activation.
- Arm Adjustment: 5"(127mm) height adjustment.
- Arm Pad Rotation: 360°.
- 3"(76mm) sliding seat pan.
- Casters: Standard with hard casters; for optional soft casters.
- Standard plastic base or optional high arc base.
- Mechanism: Swivel with synchronized-tilt.
- Height Adjustment: Pneumatic, or pneumatic with low-position seat height option.
- Optional Back-Lock: Lockable in two positions.
- Optional Forward Tilt: Lockable in 3 positions.
- Tilt tension.
- Optional Adjustable Air Lumbar: additional 1.5"(38mm) of lumbar support.
- COM yardage / COL square footage: Polypropylene shell: 2.13/45

To Order, Specify:

- 1) Product number.
- 2) Fabric surface and color. (NOTE: For leather upholstery, see page 0.)
- 3) Trim color for shell, arms and base.

Shells	Arms/Caps	Number	Fabric Grade		C	D	E	F	G	H	Leather Grade A	Leather Grade B
			A	B								
Pneumatic Height Adjustment												
Polypropylene	Standard	M251-1H42	\$1819.59	\$1916.25	\$2017.51	\$2068.13	\$2112.59	\$2201.65	\$2282.91	\$2508.47	\$2664.91	\$2896.49
	Vinyl Gel	M251-1G42	1903.97	2000.63	2101.89	2152.51	2196.97	2286.03	2367.29	2592.85	2749.29	2980.87
	Upholstered	M251-1U42	1963.80	2060.46	2161.72	2212.34	2256.80	2345.86	2427.12	2652.68	2809.12	3040.70
Pneumatic Height Adjustment/Back-Lock												
Polypropylene	Standard	M251-1H41	\$1885.57	\$1982.23	\$2083.49	\$2134.11	\$2178.57	\$2267.63	\$2348.89	\$2574.45	\$2730.89	\$2962.47
	Vinyl Gel	M251-1G41	1969.95	2066.61	2167.87	2218.49	2262.95	2352.01	2433.27	2658.83	2815.27	3046.85
	Upholstered	M251-1U41	2029.78	2126.44	2227.70	2278.32	2322.78	2411.84	2493.10	2718.66	2875.10	3106.68
Pneumatic Height Adjustment/Forward-Tilt												
Polypropylene	Standard	M261-1H42	\$1884.02	\$1980.68	\$2081.94	\$2132.56	\$2177.02	\$2266.08	\$2347.34	\$2572.90	\$2729.34	\$2960.92
	Vinyl Gel	M261-1G42	1968.40	2065.06	2166.32	2216.94	2261.40	2350.46	2431.72	2657.28	2813.72	3045.30
	Upholstered	M261-1U42	2028.23	2124.89	2226.15	2276.77	2321.23	2410.29	2491.55	2717.11	2873.55	3105.13
Pneumatic Height Adjustment with Adjustable Air Lumbar												
Polypropylene	Standard	M251-1H44	\$1979.16	\$2075.82	\$2177.08	\$2227.70	\$2272.16	\$2361.22	\$2442.48	\$2668.04	\$2824.48	\$3056.06
	Vinyl Gel	M251-1G44	2063.54	2160.20	2261.46	2312.08	2356.54	2445.60	2526.86	2752.42	2908.86	3140.44
	Upholstered	M251-1U44	2123.37	2220.03	2321.29	2371.91	2416.37	2505.43	2586.69	2812.25	2968.69	3200.27
Pneumatic Height Adjustment/Back-Lock with Adjustable Air Lumbar												
Polypropylene	Standard	M251-1H43	\$2045.14	\$2141.80	\$2243.06	\$2293.68	\$2338.14	\$2427.20	\$2508.46	\$2734.02	\$2890.46	\$3122.04
	Vinyl Gel	M251-1G43	2129.52	2226.18	2327.44	2378.06	2422.52	2511.58	2592.84	2818.40	2974.84	3206.42
	Upholstered	M251-1U43	2189.35	2286.01	2387.27	2437.89	2482.35	2571.41	2652.67	2878.23	3034.67	3266.25
Pneumatic Height Adjustment/Forward-Tilt with Adjustable Air Lumbar												
Polypropylene	Standard	M261-1H44	\$2043.59	\$2140.25	\$2241.51	\$2292.13	\$2336.59	\$2425.65	\$2506.91	\$2732.47	\$2888.91	\$3120.49
	Vinyl Gel	M261-1G44	2127.97	2224.63	2325.89	2376.51	2420.97	2510.03	2591.29	2816.85	2973.29	3204.87
	Upholstered	M261-1U44	2187.80	2284.46	2385.72	2436.34	2480.80	2569.86	2651.12	2876.68	3033.12	3264.70

The following options require modification of the product number.

- High arc base To specify, change the 4th digit from a 1 to a 5; **Example:** M255-1H42
- ~~Steel base - Standard height To specify, change the 4th digit from a 1 to a 6; **Example:** M256-1H42~~
- ~~Steel base - Low height To specify, change the 4th digit from a 1 to a 7; **Example:** M257-1H42~~
- Plastic base - Low height To specify, change the 4th digit from a 1 to a 4; **Example:** M254-1H42
- Soft casters To specify, change the 7th digit from a 4 to a 2; **Example:** M251-1H22
- Faux Leather upholstery To specify, change the 2nd digit from a 2 to a 3; **Example:** M351-1H42
- Leather upholstery To specify, change the 2nd digit from a 2 to a 1; **Example:** M151-1H42
- Stain repellent To specify, add -P to the end of the product number; **Example:** M251-1H44-P (add \$49.10 list)

NOTE: High arc base available in black only.

For available fabrics, refer to surfaces.haworth.com.

Improv Series

Improv H.E. High-Back Chair with Height and Width Adjustable 3-D Arms



M251-1W42

Dimensions

- *SH: 16" - 21"
(406mm - 533mm)
- H: 36.5" - 45"
(957mm - 1143mm)
- D: 24" - 27.25"
(610mm - 692mm)
- W: 25"(635mm)
- *SW: 19.2"(488mm)
- *SD: 16" - 19"
(406mm - 483mm)
- *AH: 3.75" - 7.75"
(95mm-197mm)
- *AW: 25.5" - 29.25"
(647mm-743mm)

* All measurements taken with the BIFMA chair measuring device.

Features

- Outer Shells: Polypropylene.
- Arms: Molded black vinyl.
- 3"(76mm) sliding seat pan.
- Casters: Standard with hard casters; or optional soft casters, see below.
- Standard plastic base or optional high arc base.
- Mechanism: Swivel with synchronized-tilt.
- Height Adjustment: Pneumatic, or pneumatic with low-position seat height option.
- Arm Adjustment: 4"(102mm) height adjustment.
- Arm Width Adjustment: 1.5"(38mm) per arm in-out adjustment.
- Arm Pad Rotation: 360°.
- Arm Adjustment Controls: Fingertip activation.
- Optional Back-Lock: Lockable in two positions.
- Optional Forward Tilt: Lockable in 3 positions.
- Tilt tension.
- Optional Adjustable Air Lumbar: additional 1.5"(38mm) of lumbar support.
- COM yardage / COL square footage: Polypropylene shell: 2.13/45

To Order, Specify:

- 1) Product number.
- 2) Fabric surface and color. (NOTE: For leather upholstery, see below.)
- 3) Trim color for shell, arms and base.

Shells	Arms/Caps	Number	Fabric Grade							Leather Grade A	Leather Grade B	
			A	B	C	D	E	F	G			H
Pneumatic Height Adjustment												
Polypropylene	Molded Black Vinyl	M251-1W42	\$1707.57	\$1804.23	\$1905.49	\$1956.11	\$2000.57	\$2089.63	\$2170.89	\$2396.45	\$2552.89	\$2784.47
Pneumatic Height Adjustment/Back-Lock												
Polypropylene	Molded Black Vinyl	M251-1W41	\$1773.55	\$1870.21	\$1971.47	\$2022.09	\$2066.55	\$2155.61	\$2236.87	\$2462.43	\$2618.87	\$2850.45
Pneumatic Height Adjustment/Forward-Tilt												
Polypropylene	Molded Black Vinyl	M261-1W42	\$1772.00	\$1868.66	\$1969.92	\$2020.54	\$2065.00	\$2154.06	\$2235.32	\$2460.88	\$2617.32	\$2848.90
Pneumatic Height Adjustment with Adjustable Air Lumbar												
Polypropylene	Molded Black Vinyl	M251-1W44	\$1867.14	\$1963.80	\$2065.06	\$2115.68	\$2160.14	\$2249.20	\$2330.46	\$2556.02	\$2712.46	\$2944.04
Pneumatic Height Adjustment/Back-Lock with Adjustable Air Lumbar												
Polypropylene	Molded Black Vinyl	M251-1W43	\$1933.12	\$2029.78	\$2131.04	\$2181.66	\$2226.12	\$2315.18	\$2396.44	\$2622.00	\$2778.44	\$3010.02
Pneumatic Height Adjustment/Forward-Tilt with Adjustable Air Lumbar												
Polypropylene	Molded Black Vinyl	M261-1W44	\$1931.57	\$2028.23	\$2129.49	\$2180.11	\$2224.57	\$2313.63	\$2394.89	\$2620.45	\$2776.89	\$3008.47

The following options require modification of the product number.

High arc base	To specify, change the 4th digit from a 1 to a 5; Example: M255-1W42
Steel base - Standard height	To specify, change the 4th digit from a 1 to a 6; Example: M256-1W42
Steel base - Low height	To specify, change the 4th digit from a 1 to a 7; Example: M257-1W42
Plastic base - Low height	To specify, change the 4th digit from a 1 to a 4; Example: M254-1W42
Soft casters	To specify, change the 7th digit from a 4 to a 2; Example: M251-1W22
Faux Leather upholstery	To specify, change the 2nd digit from a 2 to a 3; Example: M351-1W42
Leather upholstery	To specify, change the 2nd digit from a 2 to a 1; Example: M151-1W42
Stain repellent	To specify, add -P to the end of the product number; Example: M251-1W42-P (add \$49.10 list)

NOTE: High arc base available in black only.

For available fabrics, refer to surfaces.haworth.com.

Improv Series

Improv H.E. High-Back Chair without Arms



M251-1042

Dimensions

- *SH: 16" - 21"
(406mm - 533mm)
- H: 36.5" - 45"
(957mm-1143mm)
- D: 24" - 27.25"
(610mm - 692mm)
- W: 26.5"(673mm)
- *SW: 19.2"(488mm)
- *SD: 16" - 19"
(406mm - 483mm)

* All measurements taken with the BIFMA chair measuring device.

Features

- Outer Shells: Polypropylene.
- Casters: Standard with hard casters; or optional soft casters, see below.
- 3"(76mm) sliding seat pan.
- Standard plastic base or optional high arc base.
- Mechanism: Swivel with synchronized-tilt.
- Height Adjustment: Pneumatic.
- Optional Back-Lock: Lockable in two positions.
- Optional Forward Tilt: Lockable in 3 positions.
- Tilt tension.
- Optional Adjustable Air Lumbar: additional 1.5"(38mm) of lumbar support.
- COM yardage / COL square footage: Polypropylene shell: 2.13/45

To Order, Specify:

- 1) Product number.
- 2) Fabric surface and color. (NOTE: For leather upholstery, see below.)
- 3) Trim color for shell and base.

Shells	Number	Fabric Grade								Leather Grade A	Leather Grade B
		A	B	C	D	E	F	G	H		
Pneumatic Height Adjustment											
Polypropylene	M251-1042	\$1270.33	\$1366.99	\$1468.25	\$1518.87	\$1563.33	\$1652.39	\$1733.65	\$1959.21	\$2115.65	\$2347.23
Pneumatic Height Adjustment/Back-Lock											
Polypropylene	M251-1041	\$1336.31	\$1432.97	\$1534.23	\$1584.85	\$1629.31	\$1718.37	\$1799.63	\$2025.19	\$2181.63	\$2413.21
Pneumatic Height Adjustment/Forward-Tilt											
Polypropylene	M261-1042	\$1334.76	\$1431.42	\$1532.68	\$1583.30	\$1627.76	\$1716.82	\$1798.08	\$2023.64	\$2180.08	\$2411.66
Pneumatic Height Adjustment with Adjustable Air Lumbar											
Polypropylene	M251-1044	\$1429.90	\$1526.56	\$1627.82	\$1678.44	\$1722.90	\$1811.96	\$1893.22	\$2118.78	\$2275.22	\$2506.80
Pneumatic Height Adjustment/Back-Lock with Adjustable Air Lumbar											
Polypropylene	M251-1043	\$1495.88	\$1592.54	\$1693.80	\$1744.42	\$1788.88	\$1877.94	\$1959.20	\$2184.76	\$2341.20	\$2572.78
Pneumatic Height Adjustment/Forward-Tilt with Adjustable Air Lumbar											
Polypropylene	M261-1044	\$1494.33	\$1590.99	\$1692.25	\$1742.87	\$1787.33	\$1876.39	\$1957.65	\$2183.21	\$2339.65	\$2571.23

The following options require modification of the product number.

- High arc base
- ~~Steel base - Standard height~~
- ~~Steel base - Low height~~
- Plastic base - Low height
- Soft casters
- Faux Leather upholstery
- Leather upholstery
- Stain repellent

- To specify, change the 4th digit from a 1 to a 5; **Example:** M255-1042
- ~~To specify, change the 4th digit from a 1 to a 6; **Example:** M256-1042~~
- ~~To specify, change the 4th digit from a 1 to a 7; **Example:** M257-1042~~
- To specify, change the 4th digit from a 1 to a 4; **Example:** M254-1042
- To specify, change the 7th digit from a 4 to a 2; **Example:** M251-1022
- To specify, change the 2nd digit from a 2 to a 3; **Example:** M351-1042
- To specify, change the 2nd digit from a 2 to a 1; **Example:** M151-1042

To specify, add -P to the end of the product number; **Example:** M251-1042-P (add \$49.10 list)

NOTE: High arc base available in black only.

For available fabrics, refer to surfaces.haworth.com.

Improv Series

Improv H.E. Mid-Back Chair with Task Arms



M231-1442

Dimensions

- *SH: 16" - 21"
(406mm - 533mm)
- H: 34" - 42.5"
(864mm - 1080mm)
- D: 23" - 25.5"
(584mm - 648mm)
- W: 25"(635mm)
- *SW: 19.2"(488mm)
- *SD: 16" - 19"
(406mm - 483mm)
- *AH: 9.625"(244mm)

* All measurements taken with the BIFMA chair measuring device.

Features

- Outer Shells: Polypropylene.
- Arms: Standard, upholstered fabric or soft black vinyl arm caps.
- Casters: Standard with hard casters; or optional soft casters.
- 3"(76mm) sliding seat pan.
- Standard plastic base or optional high arc
- Mechanism: Swivel with synchronized-tilt.
- Height Adjustment: Pneumatic, or pneumatic with low-position seat height.
- Optional Back-Lock: Lockable in two positions.
- Optional Forward Tilt: Lockable in 3 positions.
- Tilt tension.
- Optional Adjustable Air Lumbar: additional 1.5"(38mm) of lumbar support.
- COM yardage / COL square footage: Polypropylene shell: 1.50/39

To Order, Specify:

- 1) Product number.
- 2) Fabric surface and color. (NOTE: For leather upholstery, see page 0.)
- 3) Trim color for shell, arms and base.

Shells	Arms/Caps	Number	Fabric Grade		C	D	E	F	G	H	Leather Grade A	Leather Grade B
			A	B								
Pneumatic Height Adjustment												
Polypropylene	Standard	M231-1442	\$1296.44	\$1393.10	\$1494.36	\$1544.98	\$1589.44	\$1678.50	\$1759.76	\$1985.32	\$2141.76	\$2373.34
	Upholstered	M231-1542	1362.42	1459.08	1560.34	1610.96	1655.42	1744.48	1825.74	2051.30	2207.74	2439.32
	Soft Black Vinyl	M231-1642	1362.42	1459.08	1560.34	1610.96	1655.42	1744.48	1825.74	2051.30	2207.74	2439.32
Pneumatic Height Adjustment/Back-Lock												
Polypropylene	Standard	M231-1441	\$1362.42	\$1459.08	\$1560.34	\$1610.96	\$1655.42	\$1744.48	\$1825.74	\$2051.30	\$2207.74	\$2439.32
	Upholstered	M231-1541	1428.40	1525.06	1626.32	1676.94	1721.40	1810.46	1891.72	2117.28	2273.72	2505.30
	Soft Black Vinyl	M231-1641	1428.40	1525.06	1626.32	1676.94	1721.40	1810.46	1891.72	2117.28	2273.72	2505.30
Pneumatic Height Adjustment/Forward-Tilt												
Polypropylene	Standard	M241-1442	\$1360.87	\$1457.53	\$1558.79	\$1609.41	\$1653.87	\$1742.93	\$1824.19	\$2049.75	\$2206.19	\$2437.77
	Upholstered	M241-1542	1426.85	1523.51	1624.77	1675.39	1719.85	1808.91	1890.17	2115.73	2272.17	2503.75
	Soft Black Vinyl	M241-1642	1426.85	1523.51	1624.77	1675.39	1719.85	1808.91	1890.17	2115.73	2272.17	2503.75
Pneumatic Height Adjustment with Adjustable Air Lumbar												
Polypropylene	Standard	M231-1444	\$1456.01	\$1552.67	\$1653.93	\$1704.55	\$1749.01	\$1838.07	\$1919.33	\$2144.89	\$2301.33	\$2532.91
	Upholstered	M231-1544	1521.99	1618.65	1719.91	1770.53	1814.99	1904.05	1985.31	2210.87	2367.31	2598.89
	Soft Black Vinyl	M231-1644	1521.99	1618.65	1719.91	1770.53	1814.99	1904.05	1985.31	2210.87	2367.31	2598.89
Pneumatic Height Adjustment/Back-Lock with Adjustable Air Lumbar												
Polypropylene	Standard	M231-1443	\$1521.99	\$1618.65	\$1719.91	\$1770.53	\$1814.99	\$1904.05	\$1985.31	\$2210.87	\$2367.31	\$2598.89
	Upholstered	M231-1543	1587.97	1684.63	1785.89	1836.51	1880.97	1970.03	2051.29	2276.85	2433.29	2664.87
	Soft Black Vinyl	M231-1643	1587.97	1684.63	1785.89	1836.51	1880.97	1970.03	2051.29	2276.85	2433.29	2664.87
Pneumatic Height Adjustment/Forward-Tilt with Adjustable Air Lumbar												
Polypropylene	Standard	M241-1444	\$1520.44	\$1617.10	\$1718.36	\$1768.98	\$1813.44	\$1902.50	\$1983.76	\$2209.32	\$2365.76	\$2597.34
	Upholstered	M241-1544	1586.42	1683.08	1784.34	1834.96	1879.42	1968.48	2049.74	2275.30	2431.74	2663.32
	Soft Black Vinyl	M241-1644	1586.42	1683.08	1784.34	1834.96	1879.42	1968.48	2049.74	2275.30	2431.74	2663.32

The following options require modification of the product number.

- Low-position seat height - Plastic
- High arc base
- ~~Steel base - Standard height~~
- ~~Steel base - Low height~~
- Soft casters
- Faux Leather upholstery
- Leather upholstery
- Stain repellent

- To specify, change the 4th digit from a 1 to a 4; **Example:** M234-1442
- To specify, change the 4th digit from a 1 to a 5; **Example:** M235-1442
- ~~To specify, change the 4th digit from a 1 to a 6; **Example:** M236-1442~~
- ~~To specify, change the 4th digit from a 1 to a 7; **Example:** M237-1442~~
- To specify, change the 7th digit from a 4 to a 2; **Example:** M231-1422
- To specify, change the 2nd digit from a 2 to a 3; **Example:** M331-1442
- To specify, change the 2nd digit from a 2 to a 1; **Example:** M131-1442
- To specify, add -P to the end of the product number; **Example:** M231-1444-P (add \$49.10 list)

NOTE: High arc base available in black only.

For available fabrics, refer to surfaces.haworth.com.

Improv Series

Improv H.E. Mid-Back Chair with Height Adjustable Task Arms



M231-1742

Dimensions

- *SH: 16" - 21"
(406mm - 533mm)
- H: 34" - 42.5"
(864mm - 1080mm)
- D: 23" - 25.5"
(584mm - 648mm)
- W: 25"(635mm)
- *SW: 19.2"(488mm)
- *SD: 16" - 19"
(406mm - 483mm)
- *AH: 4.6" - 8.4"
(117mm-213mm)

* All measurements taken with the BIFMA chair measuring device.

Features

- Outer Shells: Polypropylene.
- Arms: Standard, upholstered fabric or soft black vinyl arm caps.
- Arm Adjustment Controls: Fingertip activation.
- Casters: Standard with hard casters; or optional soft casters.
- 3"(76mm) sliding seat pan.
- Standard plastic base or optional high arc, or steel base.
- Mechanism: Swivel with synchronized-tilt.
- Height Adjustment: Pneumatic, or pneumatic with low-position seat height option.
- Arm Adjustment: 4"(102mm) height adjustment.
- Optional Back-Lock: Lockable in two positions.
- Optional Forward Tilt: Lockable in 3 positions.
- Tilt tension.
- Optional Adjustable Air Lumbar: additional 1.5"(38mm) of lumbar support.
- COM yardage / COL square footage: Polypropylene shell: 1.50/39

To Order, Specify:

- 1) Product number.
- 2) Fabric surface and color. (NOTE: For leather upholstery, see page 10.)
- 3) Trim color for shell, arm, and base.

Shells	Arms/Caps	Number	Fabric Grade								Leather Grade A	Leather Grade B
			A	B	C	D	E	F	G	H		
Pneumatic Height Adjustment												
Polypropylene	Standard	M231-1742	\$1434.51	\$1531.17	\$1632.43	\$1733.05	\$1837.51	\$1816.57	\$1897.83	\$2123.39	\$2279.83	\$2511.41
	Upholstered	M231-1842	1500.49	1597.15	1698.41	1749.03	1793.49	1882.55	1963.81	2189.37	2345.81	2577.39
	Soft Black Vinyl	M231-1942	1500.49	1597.15	1698.41	1749.03	1793.49	1882.55	1963.81	2189.37	2345.81	2577.39
Pneumatic Height Adjustment/Back-Lock												
Polypropylene	Standard	M231-1741	\$1500.49	\$1597.15	\$1698.41	\$1749.03	\$1793.49	\$1882.55	\$1963.81	\$2189.37	\$2345.81	\$2577.39
	Upholstered	M231-1841	1566.47	1663.13	1764.39	1815.01	1859.47	1948.53	2029.79	2255.35	2411.79	2643.37
	Soft Black Vinyl	M231-1941	1566.47	1663.13	1764.39	1815.01	1859.47	1948.53	2029.79	2255.35	2411.79	2643.37
Pneumatic Height Adjustment/Forward-Tilt												
Polypropylene	Standard	M241-1742	\$1498.94	\$1595.60	\$1696.86	\$1747.48	\$1791.94	\$1881.00	\$1962.26	\$2187.82	\$2344.26	\$2575.84
	Upholstered	M241-1842	1564.98	1661.64	1762.84	1813.46	1857.92	1946.98	2028.24	2253.80	2410.24	2641.82
	Soft Black Vinyl	M241-1942	1564.98	1661.64	1762.84	1813.46	1857.92	1946.98	2028.24	2253.80	2410.24	2641.82
Pneumatic Height Adjustment with Adjustable Air Lumbar												
Polypropylene	Standard	M231-1744	\$1600.06	\$1690.74	\$1792.00	\$1842.62	\$1887.08	\$1976.14	\$2057.40	\$2282.96	\$2439.40	\$2670.98
	Upholstered	M231-1844	1726.04	1756.72	1857.98	1908.60	1953.06	2042.12	2123.38	2348.94	2505.38	2736.96
	Soft Black Vinyl	M231-1944	1726.04	1756.72	1857.98	1908.60	1953.06	2042.12	2123.38	2348.94	2505.38	2736.96
Pneumatic Height Adjustment/Back-Lock with Adjustable Air Lumbar												
Polypropylene	Standard	M231-1743	\$1660.06	\$1756.72	\$1857.98	\$1908.60	\$1953.06	\$2042.12	\$2123.38	\$2348.94	\$2505.38	\$2736.96
	Upholstered	M231-1843	1726.04	1822.70	1923.96	1974.58	2019.04	2108.10	2189.36	2414.92	2571.36	2802.94
	Soft Black Vinyl	M231-1943	1726.04	1822.70	1923.96	1974.58	2019.04	2108.10	2189.36	2414.92	2571.36	2802.94
Pneumatic Height Adjustment/Forward-Tilt with Adjustable Air Lumbar												
Polypropylene	Standard	M241-1744	\$1658.51	\$1755.17	\$1856.43	\$1907.05	\$1951.51	\$2040.57	\$2121.83	\$2347.39	\$2503.83	\$2735.41
	Upholstered	M241-1844	1724.49	1821.15	1922.41	1973.03	2017.49	2106.55	2187.81	2413.37	2569.81	2801.39
	Soft Black Vinyl	M241-1944	1724.49	1821.15	1922.41	1973.03	2017.49	2106.55	2187.81	2413.37	2569.81	2801.39

The following options require modification of the product number.

- Low position seat height - Plastic
- High arc base
- Steel base - Standard height
- Steel base - Low height
- Soft casters
- Faux Leather upholstery
- Leather upholstery
- Stain repellent

To specify, change the 4th digit from a 1 to a 4; **Example:** M234-1742
 To specify, change the 4th digit from a 1 to a 5; **Example:** M235-1742
 To specify, change the 4th digit from a 1 to a 6; **Example:** M236-1742
 To specify, change the 4th digit from a 1 to a 7; **Example:** M237-1742
 To specify, change the 7th digit from a 4 to a 2; **Example:** M231-1722
 To specify, change the 2nd digit from a 2 to a 3; **Example:** M331-1742
 To specify, change the 2nd digit from a 2 to a 1; **Example:** M131-1742
 To specify, add -P to the end of the product number; **Example:** M231-1744-P (add \$49.10 list)

NOTE: High arc base available in black only.

For available fabrics, refer to surfaces.haworth.com.

Improv Series

Improv H.E. Mid-Back Chair with Flipper Arms



M231-1H42

NOTE:
M241-1G42 offers the best value package of options for this model.

Dimensions

- *SH: 16" - 21"
(406mm - 533mm)
- H: 34" - 42.5"
(864mm-1080mm)
- D: 23" - 25.5"
(584mm - 648mm)
- W: 26.5"(673mm)
- *SW: 19.2"(488mm)
- *SD: 16" - 19"
(406mm - 483mm)
- *AH: 6.2" - 11.3"
(157mm-287mm)

* All measurements taken with the BIFMA chair measuring device.

Features

- Outer Shells: Polypropylene.
- Arms: Standard, upholstered fabric or black vinyl gel arm caps.
- Arm Adjustment Controls: Fingertip activation.
- 3"(76mm) Sliding seat pan.
- Casters: Standard with hard casters; or optional soft casters.
- Standard plastic base or optional high arc base.
- Mechanism: Swivel with synchronized-tilt.
- Height Adjustment: Pneumatic, or pneumatic with low-position seat height option.
- Arm Adjustment: 5"(127mm) height adjustment.
- Arm Pad Rotation: 360°.
- Optional Back-Lock: Lockable in two positions.
- Optional Forward Tilt: Lockable in 3 positions.
- Tilt tension.
- Optional Adjustable Air Lumbar: additional 1.5"(38mm) of lumbar support.
- COM yardage / COL square footage:
Polypropylene shell: 1.50/39

To Order, Specify:

- 1) Product number.
- 2) Fabric surface and color.
(NOTE: For leather upholstery, see page 0.)
- 3) Trim color for shell, arms and base.

Shells	Arms/Caps	Number	Fabric Grade		C	D	E	F	G	H	Leather Grade A	Leather Grade B
			A	B								
Pneumatic Height Adjustment												
Polypropylene	Standard	M231-1H42	\$1716.81	\$1813.47	\$1914.73	\$1965.35	\$2009.81	\$2098.87	\$2180.13	\$2405.69	\$2562.13	\$2793.71
	Vinyl Gel	M231-1G42	1801.19	1897.85	1999.11	2049.73	2094.19	2183.25	2264.51	2490.07	2646.51	2878.09
	Upholstered	M231-1U42	1861.02	1957.68	2058.94	2109.56	2154.02	2243.08	2324.34	2549.90	2706.34	2937.92
Pneumatic Height Adjustment/Back-Lock												
Polypropylene	Standard	M231-1H41	\$1782.79	\$1879.45	\$1980.71	\$2031.33	\$2075.79	\$2164.85	\$2246.11	\$2471.67	\$2628.11	\$2859.69
	Vinyl Gel	M231-1G41	1867.17	1963.83	2065.09	2115.71	2160.17	2249.23	2330.49	2556.05	2712.49	2944.07
	Upholstered	M231-1U41	1927.00	2023.66	2124.92	2175.54	2220.00	2309.06	2390.32	2615.88	2772.32	3003.90
Pneumatic Height Adjustment/Forward-Tilt												
Polypropylene	Standard	M241-1H42	\$1781.24	\$1877.90	\$1979.16	\$2029.78	\$2074.24	\$2163.30	\$2244.56	\$2470.12	\$2626.56	\$2858.14
	Vinyl Gel	M241-1G42	1865.62	1962.28	2063.54	2114.16	2158.62	2247.68	2328.94	2554.50	2710.94	2942.52
	Upholstered	M241-1U42	1925.45	2022.11	2123.37	2173.99	2218.45	2307.51	2388.77	2614.33	2770.77	3002.35
Pneumatic Height Adjustment with Adjustable Air Lumbar												
Polypropylene	Standard	M231-1H44	\$1876.38	\$1973.04	\$2074.30	\$2124.92	\$2169.38	\$2258.44	\$2339.70	\$2565.26	\$2721.70	\$2953.28
	Vinyl Gel	M231-1G44	1960.76	2057.42	2158.68	2209.30	2253.76	2342.82	2424.08	2649.64	2806.08	3037.66
	Upholstered	M231-1U44	2020.59	2117.25	2218.51	2269.13	2313.59	2402.65	2483.91	2709.47	2865.91	3097.49
Pneumatic Height Adjustment/Back-Lock with Adjustable Air Lumbar												
Polypropylene	Standard	M231-1H43	\$1942.36	\$2039.02	\$2140.28	\$2190.90	\$2235.36	\$2324.42	\$2405.68	\$2631.24	\$2787.68	\$3019.26
	Vinyl Gel	M231-1G43	2026.74	2123.40	2224.66	2275.28	2319.74	2408.80	2490.06	2715.62	2872.06	3103.64
	Upholstered	M231-1U43	2086.57	2183.23	2284.49	2335.11	2379.57	2468.63	2549.89	2775.45	2931.89	3163.47
Pneumatic Height Adjustment/Forward-Tilt with Adjustable Air Lumbar												
Polypropylene	Standard	M241-1H44	\$1940.81	\$2037.47	\$2138.73	\$2189.35	\$2233.81	\$2322.87	\$2404.13	\$2629.69	\$2786.13	\$3017.71
	Vinyl Gel	M241-1G44	2025.19	2121.85	2223.11	2273.73	2318.19	2407.25	2488.51	2714.07	2870.51	3102.09
	Upholstered	M241-1U44	2085.02	2181.68	2282.94	2333.56	2378.02	2467.08	2548.34	2773.90	2930.34	3161.92

The following options require modification of the product number.

- Low-position seat height - Plastic
- High arc base
- ~~Steel base - Standard height~~
- ~~Steel base - Low height~~
- Soft casters
- Faux Leather upholstery
- Leather upholstery
- Stain repellent

- To specify, change the 4th digit from a 1 to a 4; **Example:** M234-1H42
- To specify, change the 4th digit from a 1 to a 5; **Example:** M235-1H42
- ~~To specify, change the 4th digit from a 1 to a 6; **Example:** M236-1H42~~
- ~~To specify, change the 4th digit from a 1 to a 7; **Example:** M237-1H42~~
- To specify, change the 7th digit from a 4 to a 2; **Example:** M231-1H22
- To specify, change the 2nd digit from a 2 to a 3; **Example:** M331-1H42
- To specify, change the 2nd digit from a 2 to a 1; **Example:** M131-1H42
- To specify, add -P to the end of the product number; **Example:** M231-1H44-P (add \$49.10 list)

NOTE: High arc base available in black only.

For available fabrics, refer to surfaces.haworth.com.

Improv Series

Improv H.E. Mid-Back Chair with Height and Width Adjustable 3-D Arms



M231-1W42

Dimensions

- SH: 16" - 21"
(406mm - 533mm)
- H: 34" - 42.5"
(864mm - 1080mm)
- D: 23" - 25.5"
(584mm - 648mm)
- W: 25"(635mm)
- *SW: 19.2"(488mm)
- *SD: 16" - 19"
(406mm - 483mm)
- *AH: 3.75" - 7.75"
(95mm-197mm)
- *AW: 25.5" - 29.25"
(648mm-743mm)

* All measurements taken with the BIFMA chair measuring device.

Features

- Outer Shells: Polypropylene.
- Arms: Molded black vinyl.
- 3"(76mm) Sliding seat pan.
- Casters: Standard with hard casters; or optional soft casters, see below.
- Standard plastic base or optional high arc base.
- Mechanism: Swivel with synchronized-tilt.
- Height Adjustment: Pneumatic, or pneumatic with low-position seat height option.
- Arm Adjustment: 4"(102mm) height adjustment.
- Arm Width Adjustment: 1.5"(38mm) each arm in-out adjustment.
- Arm Pad Rotation: 360°.
- Arm Adjustment Controls: Fingertip activation.
- Optional Back-Lock: Lockable in two positions.
- Optional Forward Tilt: Lockable in 3 positions.
- Tilt tension.
- Optional Adjustable Air Lumbar: additional 1.5"(38mm) of lumbar support.
- COM yardage / COL square footage: Polypropylene shell: 1.50/39

To Order, Specify:

- 1) Product number.
- 2) Fabric surface and color. (NOTE: For leather upholstery, see below.)
- 3) Trim color for shell, arms and base.

Shells	Arms/Caps	Number	Fabric Grade		C	D	E	F	G	H	Leather Grade A	Leather Grade B
			A	B								
Pneumatic Height Adjustment												
Polypropylene	Molded Black Vinyl	M231-1W42	\$1604.79	\$1701.45	\$1802.71	\$1853.33	\$1897.79	\$1986.85	\$2068.11	\$2293.67	\$2450.11	\$2681.69
Pneumatic Height Adjustment/Back-Lock												
Polypropylene	Molded Black Vinyl	M231-1W41	\$1670.77	\$1767.43	\$1868.69	\$1919.31	\$1963.77	\$2052.83	\$2134.09	\$2359.65	\$2516.09	\$2747.67
Pneumatic Height Adjustment/Forward-Tilt												
Polypropylene	Molded Black Vinyl	M241-1W42	\$1669.22	\$1765.88	\$1867.14	\$1917.76	\$1962.22	\$2051.28	\$2132.54	\$2358.10	\$2514.54	\$2746.12
Pneumatic Height Adjustment with Adjustable Air Lumbar												
Polypropylene	Molded Black Vinyl	M231-1W44	\$1764.36	\$1861.02	\$1962.28	\$2012.90	\$2057.36	\$2146.42	\$2227.68	\$2453.24	\$2609.68	\$2841.26
Pneumatic Height Adjustment/Back-Lock with Adjustable Air Lumbar												
Polypropylene	Molded Black Vinyl	M231-1W43	\$1830.34	\$1927.00	\$2028.26	\$2078.88	\$2123.34	\$2212.40	\$2293.66	\$2519.22	\$2675.66	\$2907.24
Pneumatic Height Adjustment/Forward-Tilt with Adjustable Air Lumbar												
Polypropylene	Molded Black Vinyl	M241-1W44	\$1828.79	\$1925.45	\$2026.71	\$2077.33	\$2121.79	\$2210.85	\$2292.11	\$2517.67	\$2674.11	\$2905.69

The following options require modification of the product number.

- Low-position seat height - Plastic To specify, change the 4th digit from a 1 to a 4; **Example:** M234-1W42
- High arc base To specify, change the 4th digit from a 1 to a 5; **Example:** M235-1W42
- ~~Steel base - Standard height To specify, change the 4th digit from a 1 to a 6; **Example:** M236-1W42~~
- ~~Steel base - Low height To specify, change the 4th digit from a 1 to a 7; **Example:** M237-1W42~~
- Soft casters To specify, change the 7th digit from a 4 to a 2; **Example:** M231-1W22
- Faux Leather upholstery To specify, change the 2nd digit from a 2 to a 3; **Example:** M331-1W42
- Leather upholstery To specify, change the 2nd digit from a 2 to a 1; **Example:** M131-1W42
- Stain repellent To specify, add -P to the end of the product number; **Example:** M231-1W42-P (add \$49.10 list)

NOTE: High arc base available in black only.

For available fabrics, refer to surfaces.haworth.com.

Improv Series

Improv H.E. Mid-Back Chair without Arms



M231-1042

Dimensions

- *SH: 16" - 21"
(406mm - 533mm)
- H: 34" - 42.5"
(864mm - 1080mm)
- D: 23" - 25.5"
(584mm - 648mm)
- W: 26.5"(673mm)
- *SW: 19.2"(488mm)
- *SD: 16" - 19"
(406mm - 483mm)

* All measurements taken with the BIFMA chair measuring device.

Features

- Outer Shells: Polypropylene.
- 3"(76mm) Sliding seat pan.
- Casters: Standard with hard casters; or optional soft casters, see below.
- Standard plastic base or optional high arc base.
- Mechanism: Swivel with synchronized-tilt.
- Height Adjustment: Pneumatic, or pneumatic with low-position seat height option.
- Optional Back-Lock: Lockable in two positions.
- Optional Forward Tilt: Lockable in 3 positions.
- Tilt tension.
- Optional Adjustable Air Lumbar models available: additional 1.5"(38mm) of lumbar support.
- COM yardage / COL square footage:
Polypropylene shell: 1.50/39

To Order, Specify:

- 1) Product number.
- 2) Fabric surface and color. (NOTE: For leather upholstery, see below.)
- 3) Trim color for shell and base.

Shells	Number	Fabric Grade								Leather Grade A	Leather Grade B
		A	B	C	D	E	F	G	H		
Pneumatic Height Adjustment											
Polypropylene	M231-1042	\$1167.55	\$1264.21	\$1365.47	\$1416.09	\$1460.55	\$1549.61	\$1630.87	\$1856.43	\$2012.87	\$2244.45
Pneumatic Height Adjustment/Back-Lock											
Polypropylene	M231-1041	\$1233.53	\$1330.19	\$1431.45	\$1482.07	\$1526.53	\$1615.59	\$1696.85	\$1922.41	\$2078.85	\$2310.43
Pneumatic Height Adjustment/Forward-Tilt											
Polypropylene	M241-1042	\$1231.98	\$1328.64	\$1429.90	\$1480.52	\$1524.98	\$1614.04	\$1695.30	\$1920.86	\$2077.30	\$2308.88
Pneumatic Height Adjustment with Adjustable Lumbar											
Polypropylene	M231-1044	\$1327.12	\$1423.78	\$1525.04	\$1575.66	\$1620.12	\$1709.18	\$1790.44	\$2016.00	\$2172.44	\$2404.02
Pneumatic Height Adjustment/Back-Lock with Adjustable Air Lumbar											
Polypropylene	M231-1043	\$1393.10	\$1489.76	\$1591.02	\$1641.64	\$1686.10	\$1775.16	\$1856.42	\$2081.98	\$2238.42	\$2470.00
Pneumatic Height Adjustment/Forward-Tilt with Adjustable Air Lumbar											
Polypropylene	M241-1044	\$1391.55	\$1488.21	\$1589.47	\$1640.09	\$1684.55	\$1773.61	\$1854.87	\$2080.43	\$2236.87	\$2468.45

The following options require modification of the product number.

- | | |
|---|---|
| Low-position seat height - Plastic | To specify, change the 4th digit from a 1 to a 4; Example: M234-1042 |
| High arc base | To specify, change the 4th digit from a 1 to a 5; Example: M235-1042 |
| Steel base - Standard height | To specify, change the 4th digit from a 1 to a 6; Example: M236-1042 |
| Steel base - Low height | To specify, change the 4th digit from a 1 to a 7; Example: M237-1042 |
| Soft casters | To specify, change the 7th digit from a 4 to a 2; Example: M231-1022 |
| Faux Leather upholstery | To specify, change the 2nd digit from a 2 to a 3; Example: M331-1042 |
| Leather upholstery | To specify, change the 2nd digit from a 2 to a 1; Example: M131-1042 |
| Stain repellent | To specify, add -P to the end of the product number; Example: M231-1042-P (add \$49.10 list) |

NOTE: High arc base available in black only.

For available fabrics, refer to surfaces.haworth.com.

Improv Series

Improv H.E. Stool with Task Arms



M2E1-1442

Dimensions

- *SH: 24" - 32"
(610mm - 813mm)
- H: 42" - 54"
(1067mm - 1372mm)
- D: 23" - 25.5"
(584mm - 648mm)
- W: 25"(635mm)
- *SW: 19.2"(488mm)
- *SD: 18"(459mm)
- *AH: 9.6"(244mm)

* All measurements taken with the BIFMA chair measuring device.

Features

- Outer Shells: Polypropylene.
- Arms: Standard, upholstered fabric or soft black vinyl arm caps.
- Casters: Standard with hard casters; or optional soft casters or glides.
- Mechanism: Swivel with synchronized-tilt.
- Height Adjustment: Pneumatic
- Optional Back-Lock: Lockable in two positions.
- Tilt tension.
- Optional Adjustable Air Lumbar: additional 1.5"(38mm) of lumbar support.
- Forward tilt not available on stools.
- Seat pan can be manually adjusted 3"(76mm).
Foot ring adjustment: 6.5" - 15"
(165mm - 381mm).
- Foot ring available in chrome only; ring support black only; base cover will match trim color.
- COM yardage / COL square footage:
Polypropylene shell: 1.75/39

To Order, Specify:

- 1) Product number.
- 2) Fabric surface and color. (NOTE: For leather upholstery, see page 0.)
- 3) Trim color for shell, arms and base.

Shells	Arms/Caps	Number	Fabric Grade		C	D	E	F	G	H	Leather Grade A	Leather Grade B
			A	B								
Pneumatic Height Adjustment												
Polypropylene	Standard	M2E1-1442	\$1989.91	\$2086.57	\$2187.83	\$2238.45	\$2282.91	\$2371.97	\$2453.23	\$2678.79	\$2835.23	\$3066.81
	Upholstered	M2E1-1542	2055.89	2152.55	2253.81	2304.43	2348.89	2437.95	2519.21	2744.77	2901.21	3132.79
	Soft Black Vinyl	M2E1-1642	2055.89	2152.55	2253.81	2304.43	2348.89	2437.95	2519.21	2744.77	2901.21	3132.79
Pneumatic Height Adjustment/Back-Lock												
Polypropylene	Standard	M2E1-1441	\$2055.89	\$2152.55	\$2253.81	\$2304.43	\$2348.89	\$2437.95	\$2519.21	\$2744.77	\$2901.21	\$3132.79
	Upholstered	M2E1-1541	2121.87	2218.53	2319.79	2370.41	2414.87	2503.93	2585.19	2810.75	2967.19	3198.77
	Soft Black Vinyl	M2E1-1641	2121.87	2218.53	2319.79	2370.41	2414.87	2503.93	2585.19	2810.75	2967.19	3198.77
Pneumatic Height Adjustment with Adjustable Air Lumbar												
Polypropylene	Standard	M2E1-1444	\$2149.48	\$2246.14	\$2347.40	\$2398.02	\$2442.48	\$2531.54	\$2612.80	\$2838.36	\$2994.80	\$3226.38
	Upholstered	M2E1-1544	2215.46	2312.12	2413.38	2464.00	2508.46	2597.52	2678.78	2904.34	3060.78	3292.36
	Soft Black Vinyl	M2E1-1644	2215.46	2312.12	2413.38	2464.00	2508.46	2597.52	2678.78	2904.34	3060.78	3292.36
Pneumatic Height Adjustment/Back-Lock with Adjustable Air Lumbar												
Polypropylene	Standard	M2E1-1443	\$2215.46	\$2312.12	\$2413.38	\$2464.00	\$2508.46	\$2597.52	\$2678.78	\$2904.34	\$3060.78	\$3292.36
	Upholstered	M2E1-1543	2281.44	2378.10	2479.36	2529.98	2574.44	2663.50	2744.76	2970.32	3126.76	3358.34
	Soft Black Vinyl	M2E1-1643	2281.44	2378.10	2479.36	2529.98	2574.44	2663.50	2744.76	2970.32	3126.76	3358.34

The following options require modification of the product number.

- Glides
- Soft casters
- Faux Leather upholstery
- Leather upholstery
- Stain repellent

- To specify, change the 7th digit from a 4 to a 0; **Example:** M2E1-1402
- To specify, change the 7th digit from a 4 to a 2; **Example:** M2E1-1422
- To specify, change the 2nd digit from a 2 to a 3; **Example:** M3E1-1442
- To specify, change the 2nd digit from a 2 to a 1; **Example:** M1E1-1442
- To specify, add **-P** to the end of the product number; **Example:** M2E1-1444-P (add \$49.10 list)

NOTE: For available fabrics, refer to surfaces.haworth.com.

Improv Series

Improv H.E. Stool with Height Adjustable Task Arms



M2E1-1742

Dimensions

- *SH: 24" - 32"
(610mm - 813mm)
- H: 42" - 54"
(1067mm - 1372mm)
- D: 23" - 25.5"
(584mm - 648mm)
- W: 25" (635mm)
- *SW: 19.2" (488mm)
- *SD: 18" (458mm)
- *AH: 6.9" - 10.8"
(175mm - 274mm)

* All measurements taken with the BIFMA chair measuring device.

Features

- Outer Shells: Polypropylene.
- Arms: Standard, upholstered fabric or soft black vinyl arm caps.
- Arm Adjustment Controls: Fingertip activation.
- Standard with hard casters; or optional soft casters or glides.
- Mechanism: Swivel with synchronized-tilt.
- Height Adjustment: Pneumatic
- Arm Adjustment: 5" (127mm) height adjustment.
- Optional Back-Lock: Lockable in two positions.
- Tilt tension.
- Optional Adjustable Air Lumbar: additional 1.5" (38mm) of lumbar support.
- Forward tilt not available on stools.
- Seat pan can be manually adjusted 3" (76mm).
- Foot ring adjustment: 6.5" - 15" (165mm - 381mm).
- Foot ring available in chrome only; rim supports black only; base cover will match trim color.
- COM yardage / COL square foot: Polypropylene shell: 1.75/39

To Order, Specify:

- 1) Product number.
- 2) Fabric surface and color. (NOTE: For leather upholstery, see page 0.)
- 3) Trim color for shells, arms and base.

Shells	Arms/Caps	Number	Fabric Grade		C	D	E	F	G	H	Leather Grade A	Leather Grade B
			A	B								
Pneumatic Height Adjustment												
Polypropylene	Standard	M2E1-1742	\$2127.98	\$2224.64	\$2321.30	\$2376.52	\$2420.98	\$2510.04	\$2591.30	\$2816.86	\$2973.30	\$3204.88
	Upholstered	M2E1-1842	2193.96	2290.62	2391.88	2442.50	2486.96	2576.02	2657.28	2882.84	3039.28	3270.86
	Soft Black Vinyl	M2E1-1942	2193.96	2290.62	2391.88	2442.50	2486.96	2576.02	2657.28	2882.84	3039.28	3270.86
Pneumatic Height Adjustment/Back-Lock												
Polypropylene	Standard	M2E1-1741	\$2193.96	\$2290.62	\$2391.88	\$2442.50	\$2486.96	\$2576.02	\$2657.28	\$2882.84	\$3039.28	\$3270.86
	Upholstered	M2E1-1841	2259.96	2356.62	2457.86	2508.48	2552.94	2642.00	2723.26	2948.82	3105.26	3336.84
	Soft Black Vinyl	M2E1-1941	2259.96	2356.62	2457.86	2508.48	2552.94	2642.00	2723.26	2948.82	3105.26	3336.84
Pneumatic Height Adjustment with Adjustable Air Lumbar												
Polypropylene	Standard	M2E1-1744	\$2287.53	\$2384.21	\$2485.47	\$2536.09	\$2580.55	\$2669.61	\$2750.87	\$2976.43	\$3132.87	\$3364.45
	Upholstered	M2E1-1844	2353.53	2450.19	2551.45	2602.07	2646.53	2735.59	2816.85	3042.41	3198.85	3430.43
	Soft Black Vinyl	M2E1-1944	2353.53	2450.19	2551.45	2602.07	2646.53	2735.59	2816.85	3042.41	3198.85	3430.43
Pneumatic Height Adjustment/Back-Lock with Adjustable Air Lumbar												
Polypropylene	Standard	M2E1-1743	\$2353.53	\$2450.19	\$2551.45	\$2602.07	\$2646.53	\$2735.59	\$2816.85	\$3042.41	\$3198.85	\$3430.43
	Upholstered	M2E1-1843	2419.51	2516.17	2617.43	2668.05	2712.51	2801.57	2882.83	3108.39	3264.83	3496.41
	Soft Black Vinyl	M2E1-1943	2419.51	2516.17	2617.43	2668.05	2712.51	2801.57	2882.83	3108.39	3264.83	3496.41

The following options require modification of the product number.

- Chrome casters
- Soft casters
- Leather upholstery
- Leather upholstery with leather repellent

To specify, change the 7th digit from a 4 to a 0; **Example:** M2E1-1702
 To specify, change the 7th digit from a 4 to a 2; **Example:** M2E1-1722
 To specify, change the 2nd digit from a 2 to a 3; **Example:** M3E1-1742
 To specify, change the 2nd digit from a 2 to a 1; **Example:** M1E1-1742
 To specify, add -P to the end of the product number; **Example:** M2E1-1744-P (add \$49.10 list)
NOTE: For available fabrics, refer to surfaces.haworth.com.



Improv Series

Improv H.E. Stool with Flipper Arms



M2E1-1H42

Dimensions

- *SH: 24" - 32"
(610mm - 813mm)
- H: 42" - 54"
(1067mm - 1372mm)
- D: 23" - 25.5"
(584mm - 648mm)
- W: 26.5"(673mm)
- *SW: 19.2"(488mm)
- *SD: 18"(458mm)
- *AH: 6.2" - 11.3"
(157mm - 282mm)

* All measurements taken with the BIFMA chair measuring device.

Features

- Outer Shells: Polypropylene.
- Arms: Standard, upholstered fabric or black vinyl arm caps.
- Arm Adjustment Controls: Fingertip activation.
- Arm Adjustment: 5"(127mm) height adjustment, 360° rotation.
- Standard with hard casters; or optional soft casters or glides.
- Mechanism: Swivel with synchronized-tilt.
- Height Adjustment: Pneumatic
- Optional Back-Lock: Lockable in two positions.
- Tilt tension.
- Optional Adjustable Air Lumbar: additional 1.5"(38mm) of lumbar support.
- Forward tilt not available on stools.
- Seat pan can be manually adjusted 3"(76mm).
- Foot ring adjustment: 6.5" - 15" (165mm - 381mm).
- Foot ring available in chrome only; ring support black only; base cover will match trim color.
- COM yardage / COL square footage:
Polypropylene shell: 1.75/39

To Order, Specify:

- 1) Product number.
- 2) Fabric surface and color. (NOTE: For leather upholstery, see page 0.)
- 3) Trim color for shell, arms and base.

Shells	Arms/Caps	Number	Fabric Grade		C	D	E	F	G	H	Leather Grade A	Leather Grade B
			A	B								
Pneumatic Height Adjustment												
Polypropylene	Standard	M2E1-1H42	\$2410.28	\$2506.94	\$2608.20	\$2658.82	\$2703.28	\$2792.34	\$2873.60	\$3099.16	\$3255.60	\$3487.18
	Vinyl Gel	M2E1-1G42	2494.66	2591.32	2692.58	2743.20	2787.66	2876.72	2957.98	3183.54	3339.98	3571.56
	Upholstered	M2E1-1U42	2554.49	2651.15	2752.41	2803.03	2847.49	2936.55	3017.81	3243.37	3399.81	3631.39
Pneumatic Height Adjustment/Back-Lock												
Polypropylene	Standard	M2E1-1H41	\$2476.26	\$2572.92	\$2674.18	\$2724.80	\$2769.26	\$2858.32	\$2939.58	\$3165.14	\$3321.58	\$3553.16
	Vinyl Gel	M2E1-1G41	2560.64	2657.30	2758.56	2809.18	2853.64	2942.70	3023.96	3249.52	3405.96	3637.54
	Upholstered	M2E1-1U41	2620.47	2717.13	2818.39	2869.01	2913.47	3002.53	3083.79	3309.35	3465.79	3697.37
Pneumatic Height Adjustment with Adjustable Air Lumbar												
Polypropylene	Standard	M2E1-1H44	\$2569.85	\$2666.51	\$2767.77	\$2818.39	\$2862.85	\$2951.91	\$3033.17	\$3258.73	\$3415.17	\$3646.75
	Vinyl Gel	M2E1-1G44	2654.23	2750.89	2852.15	2902.77	2947.23	3036.29	3117.55	3343.11	3499.55	3731.13
	Upholstered	M2E1-1U44	2714.06	2810.72	2911.98	2962.60	3007.06	3096.12	3177.38	3402.94	3559.38	3790.96
Pneumatic Height Adjustment/Back-Lock with Adjustable Air Lumbar												
Polypropylene	Standard	M2E1-1H43	\$2635.83	\$2732.49	\$2833.75	\$2884.37	\$2928.83	\$3017.89	\$3099.15	\$3324.71	\$3481.15	\$3712.73
	Vinyl Gel	M2E1-1G43	2720.21	2816.87	2918.13	2968.75	3013.21	3102.27	3183.53	3409.09	3565.53	3797.11
	Upholstered	M2E1-1U43	2780.04	2876.70	2977.96	3028.58	3073.04	3162.10	3243.36	3468.92	3625.36	3856.94

The following options require modification of the product number.

Glides

Soft casters

Faux Leather upholstery

Leather upholstery

Stain repellent

To specify, change the 7th digit from a 4 to a 0; **Example:** M2E1-1H02

To specify, change the 7th digit from a 4 to a 2; **Example:** M2E1-1H22

To specify, change the 2nd digit from a 2 to a 3; **Example:** M3E1-1H42

To specify, change the 2nd digit from a 2 to a 1; **Example:** M1E1-1H42

To specify, add -P to the end of the product number; **Example:** M2E1-2U42-P (add \$49.10 list)

NOTE: For available fabrics, refer to surfaces.haworth.com.

Improv Series

Improv H.E. Stool with Height and Width Adjustable 3-D Arms



M2E1-1W42

Dimensions

*SH: 24" - 32"
(610mm - 813mm)
H: 42" - 54"
(1067mm - 1372mm)
D: 23" - 25.5"
(584mm - 648mm)
W: 25"(635mm)
*SW: 19.2"(488mm)
*SD: 18"(458mm)
*AH: 3.75" - 7.75"
(95mm - 197mm)
*AW: 25.5" - 29.25"
(648mm - 743mm)

* All measurements taken with the BIFMA chair measuring device.

Features

- Outer Shells: Polypropylene.
- Arms: Molded black vinyl arm caps.
- Standard with hard casters; or optional soft casters or glides, see below.
- Mechanism: Swivel with synchronized-tilt.
- Height Adjustment: Pneumatic
- Arm Adjustment: 5"(127mm) height adjustment.
- Arm Width Adjustment: 1.5"(38mm) each arm in-out adjustment.
- Arm Pad Rotation: 360°.
- Arm Adjustment Controls: Fingertip activation.
- Optional Back-Lock: Lockable in two positions.
- Tilt tension.
- Optional Adjustable Air Lumbar: additional 1.5"(38mm) of lumbar support.
- Forward tilt not available on stools.
- Seat pan can be manually adjusted 3"(76mm).
- Foot ring adjustment: 6.5" - 15"
(165mm - 381mm).
- Foot ring available in chrome only; ring support black only; base cover will match trim color.
- COM yardage / COL square footage:
Polypropylene shell: 1.75/39

To Order, Specify:

- 1) Product number.
- 2) Fabric surface and color. (NOTE: For leather upholstery, see below.)
- 3) Trim color for shell, arms and base.

Shells	Arms/Caps	Number	Fabric Grade								Leather Grade A	Leather Grade B
			A	B	C	D	E	F	G	H		
Pneumatic Height Adjustment												
Polypropylene	Molded Black Vinyl	M2E1-1W42	\$2298.26	\$2394.92	\$2496.18	\$2546.80	\$2591.26	\$2680.32	\$2761.58	\$2987.14	\$3143.58	\$3375.16
Pneumatic Height Adjustment/Back-Lock												
Polypropylene	Molded Black Vinyl	M2E1-1W41	\$2364.24	\$2460.90	\$2562.16	\$2612.78	\$2657.24	\$2746.30	\$2827.56	\$3053.12	\$3209.56	\$3441.14
Pneumatic Height Adjustment with Adjustable Air Lumbar												
Polypropylene	Molded Black Vinyl	M2E1-1W44	\$2457.83	\$2554.49	\$2655.75	\$2706.37	\$2750.83	\$2839.89	\$2921.15	\$3146.71	\$3303.15	\$3534.73
Pneumatic Height Adjustment/Back-Lock with Adjustable Air Lumbar												
Polypropylene	Molded Black Vinyl	M2E1-1W43	\$2523.81	\$2620.47	\$2721.73	\$2772.35	\$2816.81	\$2905.87	\$2987.13	\$3212.69	\$3369.13	\$3600.71

The following options require modification of the product number.

Glide
Soft casters
Faux Leather upholstery
Leather upholstery
Stain repellent

To specify, change the 7th digit from a 4 to a 0; **Example:** M2E1-1W02
To specify, change the 7th digit from a 4 to a 2; **Example:** M2E1-1W22
To specify, change the 2nd digit from a 2 to a 3; **Example:** M3E1-1W42
To specify, change the 2nd digit from a 2 to a 1; **Example:** M1E1-1W42
To specify, add -P to the end of the product number; **Example:** M2E1-1W42-P (add \$49.10 list)

NOTE: For available fabrics, refer to surfaces.haworth.com.

Improv Series

Improv H.E. Stool without Arms

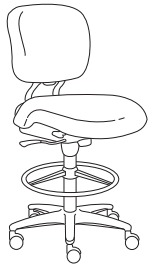

M2E1-1042

Dimensions

- *SH: 24" - 32"
(610mm - 813mm)
- H: 42" - 54"
(1067mm - 1372mm)
- D: 23" - 25.5"
(584mm - 648mm)
- W: 21" (533mm)
- *SW: 19.2" (488mm)
- *SD: 18" (457mm)

* All measurements taken with the BIFMA chair measuring device.

Features

- Outer Shells: Polypropylene.
- Standard with hard casters; or optional soft casters or glides, see below.
- Mechanism: Swivel with synchronized-tilt.
- Height Adjustment: Pneumatic
- Optional Back-Lock: Lockable in two positions.
- Tilt tension.
- Optional Adjustable Air Lumbar: additional 1.5"(38mm) of lumbar support.
- Forward tilt not available on stools.
- Seat pan can be manually adjusted 3"(76mm).
- Foot ring adjustment: 6.5" - 15" (165mm - 381mm).
- Foot ring available in chrome only; ring support black only; base cover will match trim color.
- COM yardage / COL square footage: Polypropylene shell: 1.75/39

To Order, Specify:

- 1) Product number.
- 2) Fabric surface and color. (NOTE: For leather upholstery, see below.)
- 3) Trim color for shell, arms and base.

Shells	Arms/Caps	Number	Fabric Grade		C	D	E	F	G	H	Leather Grade A	Leather Grade B
			A	B								
Pneumatic Height Adjustment												
Polypropylene		M2E1-1042	\$1861.02	\$1957.68	\$2058.94	\$2109.56	\$2154.02	\$2243.08	\$2324.34	\$2549.90	\$2706.34	\$2937.92
Pneumatic Height Adjustment/Back-Lock												
Polypropylene		M2E1-1041	\$1927.00	\$2023.66	\$2124.92	\$2175.54	\$2220.00	\$2309.06	\$2390.32	\$2615.88	\$2772.32	\$3003.90
Pneumatic Height Adjustment with Adjustable Air Lumbar												
Polypropylene		M2E1-1044	\$2020.59	\$2117.25	\$2218.51	\$2269.13	\$2313.59	\$2402.65	\$2483.91	\$2709.47	\$2865.91	\$3097.49
Pneumatic Height Adjustment/Back-Lock with Adjustable Air Lumbar												
Polypropylene		M2E1-1043	\$2086.57	\$2183.23	\$2284.49	\$2335.11	\$2379.57	\$2468.63	\$2549.89	\$2775.45	\$2931.89	\$3163.47

The following options require modification of the product number.

Glides

Soft casters

Faux Leather upholstery

Leather upholstery

Stain repellent

To specify, change the 7th digit from a 4 to a 0; **Example:** M2E1-1002

To specify, change the 7th digit from a 4 to a 2; **Example:** M2E1-1022

To specify, change the 2nd digit from a 2 to a 3; **Example:** M3E1-1042

To specify, change the 2nd digit from a 2 to a 1; **Example:** M1E1-1042

To specify, add **-P** to the end of the product number; **Example:** M2E1-1042-P (add \$49.10 list)

NOTE: For available fabrics, refer to surfaces.haworth.com.

Improv Series

Leg-Base Stacking Chairs

With Arms

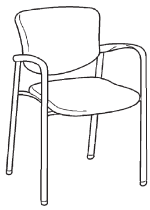

M600-2110

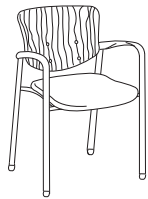
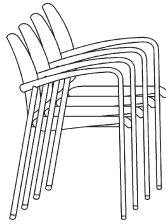

M600-2310

Dimensions

- *SH: 18"(457mm)
- H: 32"(813mm)
- D: 21.5"(546mm)
- W: 22"(559mm)
- *SD: 18"(457mm)
- *SW: 19"(483mm)
- *AH: 25.75"(654mm)

* All measurements taken with the BIFMA chair measuring device.

Features

- Optional: Full wood back.
- Optional: Legs with casters.
- Polypropylene or upholstered outer back shell.
- With glides, stacks 6-high (44"(1118mm)) on floor or 10-high (62"(1575mm)) on stacking dolly.
- With casters, stacks 5-high (42"(1067mm)) on floor or 6-high (50"(1270mm)) on dolly.
- Arms and molded floor glides match frame color except when ordering Metallic trim; molded components are available in black or smoke and must be specified.
- Non-ganging or ganging options. NOTE: An arm chair adjacent to a tablet arm cannot be ganged together.
- Optional book rack, see page 178.
- Fire retardant construction is available to comply with California Bulletin #133, see below.
- COM yardage/COL square footage:
Polypropylene back shell/upholstered seat: 0.75/15
Upholstered shell/seat: 1.25/28
Upholstered seat (wood back): 0.5

To Order, Specify:

- 1) Product number.
- 2) Fabric surface and color.
- 3) Frame/arms trim color.
- 4) Arm and glide trim color for metallic frame black or smoke option only.

To Order Chair with Wood Back, Specify:

- 1) Product number.
- 2) Fabric surface and color (seat).
- 3) Frame trim color.
- 4) Arm and glide trim color for metallic frame black or smoke option only.
- 5) Wood back finish color.

Outer/Inner Back Shell	Ganging	Number	Fabric Grade								Leather Grade A	Leather Grade B
			A	B	C	D	E	F	G	H		
Polypropylene/Upholstered	Non-ganging	M600-2110	\$601.70	\$643.92	\$661.10	\$700.18	\$736.12	\$ 795.46	\$ 837.66	\$ 953.30	\$1015.82	\$1221.02
	Ganging	M600-2110-5	673.59	715.81	732.99	772.07	808.01	867.35	909.55	1025.19	1087.71	1292.91
Upholstered/Upholstered	Non-ganging	M600-2210	\$686.07	\$742.37	\$779.87	\$834.59	\$892.38	\$ 951.76	\$1000.18	\$1147.10	\$1251.80	\$1572.64
	Ganging	M600-2210-5	757.96	814.26	851.76	906.48	964.27	1023.65	1072.07	1218.99	1323.69	1644.53
Wood Back	Non-ganging	M600-2310	\$751.74	\$793.96	\$811.14	\$850.22	\$886.16	\$ 945.50	\$ 987.70	\$1103.34	\$1165.86	\$1371.06
	Ganging	M600-2310-5	823.63	865.85	883.03	922.11	958.05	1017.39	1059.59	1175.23	1237.75	1442.95

The following options require modification of the product number.

- Metallic trim color
- Hard casters
- Soft casters
- Stain repellent
- Moisture barrier with stain repellent

- To specify, add **-M** after the 8th digit; **Example:** M600-2110-**M**
- To specify, change the 8th digit from a 0 to a 2; **Example:** M600-2112 (add \$79.68 list)
- To specify, change the 8th digit from a 0 to a 4; **Example:** M600-2114 (add \$125.40 list)
- To specify, add **-P** to the end of the product number; **Example:** M600-2110-**P** (add \$50.02 list)
- To specify, add **-D** to the end of the product number; **Example:** M600-2110-**D** (add \$65.63 list)

NOTE: Casters should not be used on thick pile carpet applications.

For available fabrics, refer to surfaces.haworth.com.

Improv Series

Leg-Base Stacking Chairs

Without Arms

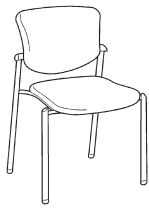

M600-2100

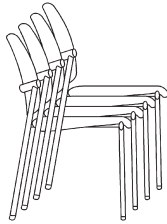

Dimensions

SH: 18"(457mm)
 H: 32"(813mm)
 D: 21.5"(546mm)
 W: 22"(559mm)
 SD: 18"(457mm)
 SW: 19"(483mm)

Features

- Optional: Full wood back.
- Polypropylene or upholstered outer back shell.
- Stacks 6-high (44"(1118mm)) on floor or 10-high (58"(1473mm)) on stacking dolly.
- High-density polyethylene leg caps and molded floor glides match frame color except when ordering Metallic trim; molded components are available in black or smoke and must be specified.
- Non-gangng or gangng options.
- Optional book rack, see page 178.
- Fire retardant construction is available to comply with California Bulletin #133, see below.
- COM yardage/COL square footage:
 Polypropylene back shell/upholstered seat: 0.75/15
 Upholstered shell/seat: 1.25/28
 Upholstered seat (wood back): 0.5

To Order, Specify:

- 1) Product number.
- 2) Fabric surface and color.
- 3) Frame trim color.
- 4) Leg caps and glides color for metallic frame black or smoke option only.

To Order Chair with Wood Back, Specify:

- 1) Product number.
- 2) Fabric surface and color (seat).
- 3) Frame trim color.
- 4) Leg caps and glides color for metallic frame black or smoke option only.
- 5) Wood back finish color.



M600-2300

Outer/Inner Back Shell	Gangng	Number	Fabric Grade								Leather Grade A	Leather Grade B
			A	B	C	D	E	F	G	H		
Polypropylene/Upholstered	Non-gangng	M600-2100	\$565.76	\$607.98	\$625.16	\$664.24	\$700.18	\$759.52	\$ 801.72	\$ 917.36	\$ 979.88	\$1185.08
	Gangng	M600-2100-5	637.65	679.87	697.05	736.13	772.07	831.41	873.61	989.25	1051.77	1256.97
Upholstered/Upholstered	Non-gangng	M600-2200	\$650.13	\$706.43	\$743.93	\$798.65	\$856.44	\$915.82	\$ 964.24	\$1111.16	\$1215.86	\$1536.70
	Gangng	M600-2200-5	722.02	778.32	815.82	870.54	928.33	987.71	1036.13	1183.05	1287.75	1608.59
Wood Back	Non-gangng	M600-2300	\$715.80	\$758.02	\$775.20	\$814.28	\$850.22	\$909.56	\$ 951.76	\$1067.40	\$1129.92	\$1335.12
	Gangng	M600-2300-5	787.69	829.91	847.09	886.17	922.11	981.45	1023.65	1139.29	1201.81	1407.01

The following options require modification of the product number.

- Metallic trim color
- Stain repellent
- Moisture barrier with stain repellent

To specify, add **-M** after the 8th digit; **Example:** M600-2100-**M**

To specify, add **-P** to the end of the product number; **Example:** M600-2100-**P** (add \$50.02 list)

To specify, add **-D** to the end of the product number; **Example:** M600-2100-**D** (add \$65.63 list)

NOTE: For available fabrics, refer to surfaces.haworth.com.

Improv Series

Sled-Base Chairs

With Arms, Non-Stacking

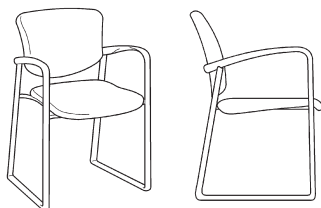

M601-2110

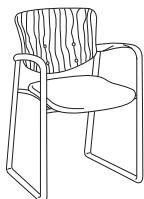

M601-2310

Dimensions

- SH: 18"(457mm)
- H: 32"(813mm)
- D: 21.5"(546mm)
- W: 22"(559mm)
- SD: 18"(457mm)
- SW: 19"(483mm)
- AH: 25.75"(654mm)

Features

- Optional: Full wood back.
- Polypropylene or upholstered outer back shell.
- Non-stacking.
- Arms and nylon sled-base runners match frame color except when ordering Metallic trim; molded components are available black or smoke and must be specified.
- Non-gangling or gangling options. NOTE: An arm chair adjacent to a tablet arm cannot be ganged together.
- Optional book rack, see page 178.
- Fire retardant construction is available to comply with California Bulletin #133, see below.
- COM yardage/COL square footage:
Polypropylene back shell/upholstered seat: 0.75/15
Upholstered shell/seat: 1.25/28
Upholstered seat (wood back): 0.5

To Order, Specify:

- 1) Product number.
- 2) Fabric surface and color.
- 3) Frame trim color.
- 4) Arm and sled base runners for metallic frame black or smoke option only.

To Order Chair with Wood Back, Specify:

- 1) Product number.
- 2) Fabric surface and color (seat).
- 3) Frame trim color.
- 4) Arm and sled base runners for metallic frame black or smoke option only.
- 5) Wood back finish color.

Outer/Inner Back Shell	Gangling	Number	Fabric Grade								Leather Grade A	Leather Grade B
			A	B	C	D	E	F	G	H		
Polypropylene/Upholstered	Non-gangling	M601-2110	\$ 782.98	\$ 825.20	\$ 842.38	\$ 881.46	\$ 917.40	\$ 976.74	\$1018.94	\$1134.58	\$1197.10	\$1402.30
	Gangling	M601-2110-5	854.87	897.09	914.27	953.35	989.29	1048.63	1090.83	1206.47	1268.99	1474.19
Upholstered/Upholstered	Non-gangling	M601-2210	\$ 867.35	\$ 923.65	\$ 961.15	\$1015.87	\$1073.66	\$1133.04	\$1181.46	\$1328.38	\$1433.08	\$1753.92
	Gangling	M601-2210-5	939.24	995.54	1033.04	1087.76	1145.55	1204.93	1253.35	1400.27	1504.97	1825.81
Wood Back	Non-gangling	M601-2310	\$ 933.02	\$ 975.24	\$ 992.42	\$1031.50	\$1067.44	\$1126.78	\$1168.98	\$1284.62	\$1347.14	\$1552.34
	Gangling	M601-2310-5	1004.91	1047.13	1064.31	1103.39	1139.33	1198.67	1240.87	1356.51	1419.03	1624.23

The following options require modification of the product number.

Metallic trim color

Stain repellent

Moisture barrier with stain repellent

To specify, add **-M** after the 8th digit; **Example:** M601-2110-**M**

To specify, add **-P** to the end of the product number; **Example:** M601-2110-**P** (add **\$50.02** list)

To specify, add **-D** to the end of the product number; **Example:** M601-2110-**D** (add **\$65.63** list)

NOTE: For available fabrics, refer to surfaces.haworth.com.

Improv Series

Sled-Base Chairs

Without Arms, Non-Stacking

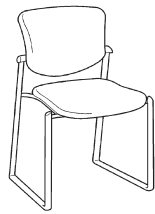

M601-2100

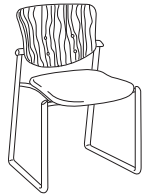
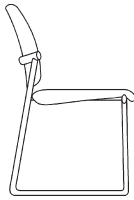

M601-2300

Dimensions

- SH: 18"(457mm)
- H: 32"(813mm)
- D: 21.5"(546mm)
- W: 22"(559mm)
- SD: 18"(457mm)
- SW: 19"(483mm)

Features

- Optional: Full wood back.
- Polypropylene or upholstered outer back shell.
- Non-stacking.
- High-density polyethylene leg caps and nylon sled-base runners match frame color except when ordering Metallic trim; molded components are available in black or smoke and must be specified.
- Wood back chairs have four color-matched bolts: black, graphite, smoke and Metallic trim chairs are standard with black bolts, and grey tone and stone chairs are standard with bronze bolts.
- Non-ganging or ganging options.
- Optional book rack, see page 178.
- Fire retardant construction is available to comply with California Bulletin #133, see below.
- COM yardage/COL square footage:
Polypropylene back shell/upholstered seat: 0.75/15
Upholstered back shell/seat: 1.25/28
Upholstered seat (wood back): 0.5

To Order, Specify:

- 1) Product number.
- 2) Fabric surface and color.
- 3) Frame trim color.
- 4) Leg caps and sled base runners color for metallic frame black or smoke option only.

To Order Chair with Wood Back, Specify:

- 1) Product number.
- 2) Fabric surface and color (seat).
- 3) Frame trim color.
- 4) Leg caps and sled base runners color for metallic frame black or smoke option only.
- 5) Wood back finish color.

Outer/Inner Back Shell	Ganging	Number	Fabric Grade								Leather Grade A	Leather Grade B
			A	B	C	D	E	F	G	H		
Polypropylene/Upholstered	Non-ganging	M601-2100	\$747.04	\$ 789.26	\$ 806.44	\$ 845.52	\$ 881.46	\$ 940.80	\$ 983.00	\$1098.64	\$1161.16	\$1366.36
	Ganging	M601-2100-5	818.93	861.15	878.33	917.41	953.35	1012.69	1054.89	1170.53	1233.05	1438.25
Upholstered/Upholstered	Non-ganging	M601-2200	\$831.41	\$ 887.71	\$ 925.21	\$ 979.93	\$1037.72	\$1097.10	\$1145.52	\$1292.44	\$1397.14	\$1717.98
	Ganging	M601-2200-5	903.30	959.60	997.10	1051.82	1109.61	1168.99	1217.41	1364.33	1469.03	1789.87
Wood Back	Non-ganging	M601-2300	\$897.08	\$ 939.30	\$ 956.48	\$ 995.56	\$1031.50	\$1090.84	\$1133.04	\$1248.68	\$1311.20	\$1516.40
	Ganging	M601-2300-5	968.97	1011.19	1028.37	1067.45	1103.39	1162.73	1204.93	1320.57	1383.09	1588.29

The following options require modification of the product number.

- Metallic trim color
- Stain repellent
- Moisture barrier with stain repellent

- To specify, add **-M** after the 8th digit; **Example:** M601-2100-**M**
- To specify, add **-P** to the end of the product number; **Example:** M601-2100-**P** (add **\$50.02** list)
- To specify, add **-D** to the end of the product number; **Example:** M601-2100-**D** (add **\$65.63** list)

NOTE: For available fabrics, refer to surfaces.haworth.com.

Improv Series

Stools

With Arms

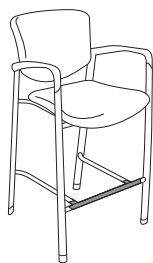

M600-8110



M600-8310

Dimensions

- SH: 27.5"(699mm)
- H: 41.25"(1048mm)
- D: 23"(584mm)
- W: 22"(559mm)
- SW: 19"(483mm)
- SD: 18"(457mm)
- BW: 18.25"(464mm)
- AH: 35.5"(902mm)
- FH: 10.5"(267mm)

Features

- Optional: Full wood back.
- Polypropylene or upholstered outer back shell.
- Arms and molded floor glides match frame color except when ordering Metallic trim; molded components are available in black or smoke and must be specified.
- Wood back chairs have four color-matched bolts: black, graphite, smoke and Metallic trim chairs are standard with black bolts, and grey tone, stone and tan chairs are standard with blackened bronze bolts.
- Distance between the arms is 19.25"(489mm).
- Foot rest nylon cover is available in charcoal finish color only.
- Fire retardant construction is available to comply with California Bulletin #133, see below.
- COM yardage/COL square footage:
Polypropylene shell: 0.75/15
Upholstered shell: 1.25/28
Upholstered seat (wood back): 0.5

To Order, Specify:

- 1) Product number.
- 2) Fabric surface and color.
- 3) Frame trim color.
- 4) Arms and glides color for metallic frame black or smoke option only.

To Order Stool with Wood Back, Specify:

- 1) Product number.
- 2) Fabric surface and color (seat).
- 3) Frame trim color.
- 4) Arms and glides color for metallic frame black or smoke option only.
- 5) Wood back finish color.

Outer/Inner Back Shell	Number	Fabric Grade		C	D	E	F	G	H	Leather Grade A	Leather Grade B
		A	B								
Polypropylene/Upholstered	M600-8110	\$1056.46	\$1098.68	\$1115.86	\$1154.94	\$1190.88	\$1250.22	\$1292.42	\$1408.06	\$1470.58	\$1675.78
Upholstered/Upholstered	M600-8210	1140.83	1197.13	1234.63	1289.35	1347.14	1406.52	1454.94	1601.86	1706.56	2027.40
Wood Back	M600-8310	1206.50	1248.72	1265.90	1304.98	1340.92	1400.26	1442.46	1558.10	1620.62	1825.82

The following options require modification of the product number.

Metallic trim color

To specify, add **-M** after the 8th digit; **Example:** M600-8110-M

Without Arms

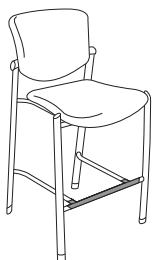

M600-8100



M600-8300

Dimensions

- SH: 27.5"(699mm)
- H: 41.25"(1048mm)
- D: 23"(584mm)
- W: 22"(559mm)
- SW: 19"(483mm)
- SD: 18"(457mm)
- BW: 18.25"(464mm)
- FH: 10.5"(267mm)

Features

- Optional: Full wood back.
- Polypropylene or upholstered outer back shell.
- High-density polyethylene leg caps and molded floor glides match frame color except when ordering Metallic trim; molded components are available in black or smoke and must be specified.
- Wood back chairs have four color-matched bolts: black, graphite, smoke and Metallic trim chairs are standard with black bolts, and grey tone, stone and tan chairs are standard with blackened bronze bolts.
- Foot rest nylon cover is available in charcoal finish color only.
- Fire retardant construction is available to comply with California Bulletin #133, see below.
- COM yardage/COL square footage:
Polypropylene shell: 0.75/15
Upholstered shell: 1.25/28
Upholstered seat (wood back): 0.5

To Order, Specify:

- 1) Product number.
- 2) Fabric surface and color.
- 3) Frame trim color.
- 4) Leg caps and glides color for metallic frame black or smoke option only.

To Order Stool with Wood Back, Specify:

- 1) Product number.
- 2) Fabric surface and color (seat).
- 3) Frame trim color.
- 4) Leg caps and glides color for metallic frame black or smoke option only.
- 5) Wood back finish color.

Polypropylene/Upholstered	M600-8100	\$1020.52	\$1062.74	\$1079.92	\$1119.00	\$1154.94	\$1214.28	\$1256.48	\$1372.12	\$1434.64	\$1639.84
Upholstered/Upholstered	M600-8200	1104.89	1161.19	1198.69	1253.41	1311.20	1370.58	1419.00	1565.92	1670.62	1991.46
Wood Back	M600-8300	1170.56	1212.78	1229.96	1269.04	1304.98	1364.32	1406.52	1522.16	1584.68	1789.88

The following options require modification of the product number.

Metallic trim color

Stain repellent

Moisture barrier with stain repellent

To specify, add **-M** after the 8th digit; **Example:** M600-8100-M

To specify, add **-P** to the end of the product number; **Example:** M600-8100-P (add \$50.02 list)

To specify, add **-D** to the end of the product number; **Example:** M600-8100-D (add \$65.63 list)

NOTE: For available fabrics, refer to surfaces.haworth.com.

Improv Series

Accessories

	Height	Width	Depth	Number	Price
Stacking Dolly	15"(381mm)	24.25"(616mm)	28"(711mm)	MPRV-CART	\$472.42

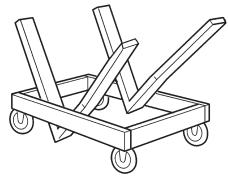

MPRV-CART

Features

- 3"(76mm) hard rubber casters.
- Recommended stacking limit is 10 chairs high (58"(1473mm) armless, 62"(1575mm) with arms, 6-high on casters (50"(1270mm)).
- Entire depth with chairs stacked is 39.75"(1010mm).
- Standard in black finish color only.
- Ships assembled.

To Order, Specify:

- 1) Product number.
(No finish specification required.)

Chair-to-Chair Connecting Bars

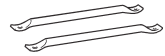

MPRV-BARS

1.25"(32mm)

MPRV-BARS

\$70.55

Features

- Connects two Improv Series chairs side-by-side.
- Width shown is distance between front legs of adjoining chairs.
- Each chair-to-chair connection requires two connecting bars.
- Price includes two (2) bars.

To Order, Specify:

- 1) Product number.
- 2) Trim color.

To order connecting bars with Metallic trim color add **-M** after eighth digit.

Example: MPRV-BARS-**M**

Improv Series

Tandem Seating

Specification and Ordering Information

Specify standard Improv Series chair models, and chair-to-chair connecting bars to create a continuous seating configuration.

Use the following guidelines when specifying and ordering Improv seating for tandem configurations:

- 1) Specify the desired chair models from pages 173-176.
 - All chair models are designed to accept chair-to-chair connecting bars.
 - NOTE: It is not necessary to order ganging chair models to create a tandem configuration.
- 2) Specify chair-to-chair connecting bars from page 178.
 - One set of connecting bars will join two chairs in tandem.

Specification Example

The following example illustrates a tandem seating configuration.

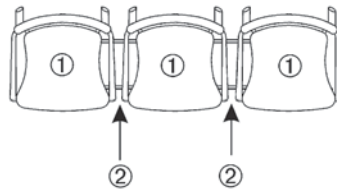

Item	Qty	Number	Description
1	3	M600-2210	Leg-Base Arm Chairs
2	2	MPRV-BARS	Chair-to-Chair Connecting Bars

Calculating Tandem Seating Dimensions

Use the following dimensions to determine the footprint of an Improv Series tandem seating configuration.

- 1) All arm and armless chair models are 22"(559mm) wide and 21.5"(546mm) deep.

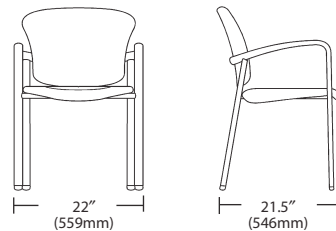

- 2) Add 1.25"(32mm) to the width of the seating run for every chair-to-chair connecting bar.

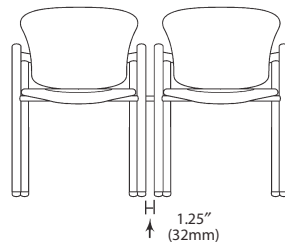

This page intentionally blank

**Features and Options
(Guest Chair)**

- Upholstered seat
- Soft mesh or upholstered back
- Soft mesh consists of chenille, poly-filament blend
- Black polypropylene arm caps
- Aluminum uprights with welded steel frame
- Finishes include: powder-coated paint (black or silver) and chrome
- Black nylon glides
- Stacks up to 4-high

Finishes and Fabrics

A complete listing of finishes and fabrics for **X99** seating is available in the back of the price list.

Environmental FactorsMaterial Off Gassing

In an effort to ensure air quality standards, all **X99** parts suppliers are required to provide Material Data Sheets and/or other documentation, verifying their products do not emit volatile organic compounds (VOC). In addition, the powder-coat paint process used in the manufacturing of **X99** seating is free of VOCs. Our manufacturing processes have also eliminated all use of chlorofluorocarbons (CFCs) and ozone depleting chemicals (ODCs) in the chair's construction.

Recycling

All **X99** seating fabric scraps are recycled, reducing the amount of material sent to landfills, and all chair components disassemble easily to increase the potential for recycling. In addition, all thermo-plastic parts are 100% reprocessible, and all raw materials used in its manufacturing can be recycled at the end of the useful life of the product. Recyclable parts are identified with the recycle symbol where practical.

**COM & COL
General Information**

To order a COM fabric (Customer's Own Material), contact the Haworth Inquiry Center (1.800.426.8562), your local Haworth dealer, or go to haworth.com/surfaces > COM Library to find out if the COM you have selected has already been tested and approved. The surface collection site also has information on the Haworth+ alliance program with Carnegie, Luna Textiles, and Maharam as well as our industry-leading Pre-Approved COM program.

COM fabrics are placed into Grades based on the cost per linear yard. If a fabric's cost exceeds the range of our highest Grade it will be noted as Non-Graded. The product will be priced at Grade A; the COM fabric costs will appear as a separate line item. The fabric charge will be Haworth's purchase cost plus a 4% administrative fee (based on the cost of the fabric). Yardage calculations will include any applicable fabric repeat.

COM Leather products will be priced at a leather Grade A; COL costs will appear as a separate line item. The leather costs will be Haworth's purchase cost plus a 4% administrative fee (based on the cost of the leather).

**Shipping Weights
(including packaging)**

- Guest chair with sled base: 35 pounds/1 chair per carton/19.5 cubic feet
- Seminar chair: 34 pounds/1 chair per carton/18.7 cubic feet
- Advanced Seminar chair: 40 pounds/1 chair per carton/16.0 cubic feet

X99

General Specifications

General Guidelines for Product Specification

	X	6	4	0	-	0	1	4	0	,	3A-18	,	M0-BL	TR-LE
Product Line	(X) X99													
Back Material	(6) Mesh	(8) Upholstered												
Chair Model	(3) Guest	(4) Seminar												
Height Adjustment	(0) Fixed Height	(1) Height Adjustable												
Base	(0) Four Leg	(2) Five-Star	(3) Sled Base											
Arms	(0) No Arms	(1) Fixed Arms												
Casters	(0) Glides	(4) Casters												
Lumbar Option	(0) No Lumbar													
Seat Upholstery	Tellure													
Back Mesh	Mesh													
Frame Color														
Trim Color														

X99

Guest Chair



X630-3100

Dimensions*

- *SH: 18”(457mm)
- H: 36”(914)
- D: 24”(610mm)
- W: 22”(559mm)
- *SW: 19”(483mm)
- *SD: 18”(457mm)
- *AH: 8”(203mm)

* All measurements taken with the BIFMA chair measuring device.

Features

- Back: Soft mesh or upholstered.
- Seat: Standard upholstered.
- Arms: Black polypropylene arm caps.
- Black glides only.
- Aluminum uprights with welded steel frame.
- COM yardage / COL square footage:
 Mesh back model: 0.5/15
 Fully upholstered model: 1.4/25

To Order, Specify:

- 1) Product number.
- 2) Fabric surface and color (seat).
- 3) Fabric or mesh surface and color (back).
- 4) Trim color for frame.
(Add **\$229.02** for chrome finish.)

Seat	Back	Arm Caps	Number	Fabric Grade								Leather Grade A	Leather Grade B
				A	B	C	D	E	F	G	H		
Upholstered	Mesh	Standard	X630-3100	\$1141.05	\$1185.77	\$1229.14	\$1252.15	\$1269.79	\$1309.09	\$1345.68	\$1445.97	\$1515.08	\$1693.44
Upholstered	Upholstered	Standard	X830-3100	1227.79	1317.23	1403.97	1449.99	1485.27	1563.87	1637.05	1837.63	1975.85	2332.57

The following options require modification of the product number.

- Stain Repellent To specify, add **-P** to end of the product number; **Example:** X630-3100-**P** (add **\$43.36** list)
- Moisture Barrier with Stain repellent To specify, add **-D** to end of the product number; **Example:** X630-3100-**D** (add **\$56.90** list)
- Leather Seat and Mesh Back To specify, change the 2nd digit in mesh back model to **5**; **Example:** X**5**30-3100
- Leather Seat and Leather Back To specify, change the 2nd digit in upholstered back model to **7**; **Example:** X**7**30-3100

NOTE: For available fabrics, refer to surfaces.haworth.com.

X99

Seminar Chair

With Arms



X840-0140

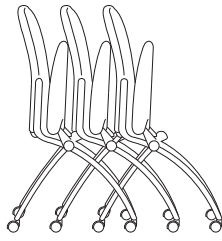

Dimensions*

- *SH: 19"(483mm)
- H: 36"(914mm)
- D: 24"(610mm)
- W: 22"(559mm)
- *SW: 19"(483mm)
- *SD: 18"(457mm)
- *AH: 8"(203mm)

* All measurements taken with the BIFMA chair measuring device.

Features

- Back: Soft mesh or upholstered.
- Seat: Standard upholstered, with folding seat.
- Arms: Black polypropylene arm caps.
- Casters: Standard with hard casters; or optional soft casters, see below.
- Optional black glides, see below.
- Aluminum uprights with welded steel frame.
- Each nested chair adds 7.5"(191mm) of floor space.
- COM yardage / COL square footage:
Mesh back model: 0.5/15
Fully upholstered model: 1.4/25
- Casters shipped unassembled.

To Order, Specify:

- 1) Product number.
- 2) Fabric surface and color (seat).
- 3) Fabric or mesh surface and color (back).
- 4) Trim color for frame.
(Add **\$386.21** for chrome finish.)

Seat	Back	Arm Caps	Number	Fabric Grade								Leather Grade A	Leather Grade B
				A	B	C	D	E	F	G	H		
Upholstered	Mesh	Standard	X640-0140	\$1097.67	\$1142.39	\$1185.76	\$1208.77	\$1226.41	\$1265.71	\$1302.30	\$1402.59	\$1471.70	\$1650.06
Upholstered	Upholstered	Standard	X840-0140	1184.41	1273.85	1360.59	1406.61	1441.89	1520.49	1593.67	1794.25	1932.47	2289.19

The following options require modification of the product number.

- Soft Caster To specify, change the 7th digit from a 4 (hard caster) to a 2 (soft caster); **Example:** X640-0120 (add **\$46.80** list)
- Glide To specify, change the 7th digit from a 4 (hard caster) to a 0; **Example:** X640-0100
- Leather Seat and Mesh Back To specify, change the 2nd digit in mesh back model to 5; **Example:** X540-0140
- Leather Seat and Leather Back To specify, change the 2nd digit in upholstered back model to 7; **Example:** X740-0140

X99

Seminar Chair

Without Arms



X640-0040

Dimensions*

- *SH: 18”(457mm)
- H: 36”(914mm)
- D: 24”(610mm)
- W: 22”(559mm)
- *SW: 19”(483mm)
- *SD: 18”(457mm)

* All measurements taken with the BIFMA chair measuring device.

Features

- Back: Soft mesh or upholstered.
- Seat: Standard upholstered, with folding seat.
- Casters: Standard with hard casters; or optional soft casters, see below.
- Optional black glides, see below.
- Aluminum uprights with welded steel frame.
- COM yardage / COL square footage:
 Mesh back model: 0.5/15
 Fully upholstered model: 1.4/25
- Casters shipped unassembled.

To Order, Specify:

- 1) Product number.
- 2) Fabric surface and color (seat).
- 3) Fabric surface and color (back). (Specify M0-BL for mesh back).
- 4) Trim color for frame. (Add **\$386.21** for chrome finish.)

Seat	Back	Number	Fabric Grade								Leather Grade A	Leather Grade B
			A	B	C	D	E	F	G	H		
Upholstered	Mesh	X640-0040	\$1027.20	\$1071.92	\$1115.29	\$1138.30	\$1155.94	\$1195.24	\$1231.83	\$1332.12	\$1401.23	\$1579.59
Upholstered	Upholstered	X840-0040	1113.94	1203.38	1290.12	1336.14	1371.42	1450.02	1523.20	1723.78	1862.00	2218.72

The following options require modification of the product number.

- Soft Caster
To specify, change the 7th digit from a **4** (hard caster) to a **2** (soft caster); **Example:** X640-0020 (add **\$46.80** list)
- Glide
To specify, change the 7th digit from a **4** (hard caster) to a **0**; **Example:** X640-0000
- Stain repellent
To specify, add **-P** to end of the product number; **Example:** X640-0040-**P** (add **\$43.36** list)
- Moisture Barrier with Stain Repellent
To specify, add **-D** to end of the product number; **Example:** X640-0040-**D** (add **\$56.90** list)
- Leather Seat and Mesh Back
To specify, change the 2nd digit in mesh back model to **5**; **Example:** X540-0040
- Leather Seat and Leather Back
To specify, change the 2nd digit in upholstered back model to **7**; **Example:** X740-0040

NOTE: For available fabrics, refer to surfaces.haworth.com.

X99

Advanced Seminar Chair

With Arms



X641-2140

Dimensions*

- *SH: 16" - 21"
(406mm - 533mm)
- H: 33.5" - 38.5"
(851mm - 978mm)
- D: 26.5"(673mm)
- W: 26.5"(673mm)
- *SW: 18.5"(470mm)
- *SD: 16"(406mm)
- *AH: 8"(203mm)

* All measurements taken with the BIFMA chair measuring device.

Features

- Back: Soft mesh or upholstered.
- Seat: Standard upholstered.
- Arms: Black polypropylene arm caps.
- Base: Five-star aluminum base.
- Pneumatic seat height adjustment range 16"(406mm)-21"(533mm).
- Casters: Standard with hard casters; or optional soft casters, see below.
- Back tilts backward 21° from the upright position.
- Optional chrome finish chairs are standard with chrome base, uprights and back crossbar.
- COM yardage / COL square footage:
Mesh back model: 0.5/15
Fully upholstered model: 1.4/25

To Order, Specify:

- 1) Product number.
- 2) Fabric surface and color (seat).
- 3) Fabric or mesh surface and color (back).
- 4) Trim color for frame. (Add **\$386.21** for chrome finish.)

Seat	Back	Arm Caps	Number	Fabric Grade								Leather Grade A	Leather Grade B
				A	B	C	D	E	F	G	H		
Upholstered	Mesh	Standard	X641-2140	\$1272.50	\$1317.22	\$1360.59	\$1383.60	\$1401.24	\$1440.54	\$1477.13	\$1577.42	\$1646.53	\$1824.89
Upholstered	Upholstered	Standard	X841-2140	1359.24	1448.68	1535.42	1581.44	1616.72	1695.32	1768.50	1969.08	2107.30	2464.02

The following options require modification of the product number.

- Soft Caster To specify, change the 7th digit from a **4** (hard caster) to a **2** (soft caster); **Example:** X641-2120 (add **\$46.80** list)
- Leather Seat and Mesh Back To specify, change the 2nd digit in mesh back model to **5**; **Example:** X541-2140
- Leather Seat and Leather Back To specify, change the 2nd digit in upholstered back model to **7**; **Example:** X741-2140

X99

Advanced Seminar Chair

Without Arms

X641-2040

Dimensions*

*SH: 16"- 21"
(406mm - 533mm)
H: 33.5" - 38.5"
(851mm - 978mm)
D: 26.5"(673mm)
W: 26.5"(673mm)
*SW: 18.5"(470mm)
*SD: 16"(406mm)

* All measurements taken with the BIFMA chair measuring device.

Features

- Back: Soft mesh or upholstered.
- Seat: Standard upholstered.
- Base: Five-star aluminum base.
- Pneumatic seat height adjustment range 16"(406mm)-21"(533mm).
- Casters: Standard with hard casters; or optional soft casters, see below.
- Back tilts backward 21° from the upright position.
- Optional chrome finish chairs are standard with chrome base, uprights and back crossbar.
- COM yardage / COL square footage:
Mesh back model: 0.5/15
Fully upholstered model: 1.4/25

To Order, Specify:

- 1) Product number.
- 2) Fabric surface and color (seat).
- 3) Fabric surface and color (back).
- 4) Trim color for frame. (Add **\$386.21** for chrome finish.)

Seat	Back	Number	Fabric Grade						Leather Grade A	Leather Grade B		
			A	B	C	D	E	F			G	H
Upholstered	Mesh	X641-2040	\$1203.38	\$1248.10	\$1291.47	\$1314.48	\$1332.12	\$1371.42	\$1408.01	\$1508.30	\$1577.41	\$1755.77
Upholstered	Upholstered	X841-2040	1290.12	1379.56	1466.30	1512.32	1547.60	1626.20	1699.38	1899.96	2038.18	2394.90

The following options require modification of the product number.

Soft Caster	To specify, change the 7th digit from a 4 (hard caster) to a 2 (soft caster); Example: X641-2020 (add \$46.80 list)
Stain repellent	To specify, add -P to end of the product number; Example: X641-2040- P (add \$43.36 list)
Leather Seat and Mesh Back	To specify, change the 2nd digit in mesh back model to 5 ; Example: X541-2040
Leather Seat and Leather Back	To specify, change the 2nd digit in upholstered back model to 7 ; Example: X741-2040

NOTE: For available fabrics, refer to surfaces.haworth.com.

This page intentionally blank

Maari
General Specifications

Designer	Patricia Urquiola
Maari	The Maari family of seating offers numerous functional combinations in one, broad chair line to specify in almost any setting. The statement of line is rooted in a one-piece, textured, molded shell that is the same for all chairs for simplicity of specification.
Awards	2018 Interior Design Best of Year winner.
Features and Options	<ul style="list-style-type: none"> • High-strength polymer shell can be retrofitted from one base to another including from chair to stool. • Available in standard seat height, counter height and bar height. • Optional upholstered seat pad or seat and back pad option available. • Options include: <ul style="list-style-type: none"> -Sled Base Chair and Stools <ul style="list-style-type: none"> Chair and Stools available with plastic or felt glides. Chair available arm or armless. Stool available as armless only. Chairs stack 5 high on the floor and 8 high upholstered or 16 high non-upholstered on the Very wire stacker cart. -Four-Leg Chair and Stools <ul style="list-style-type: none"> Chair and Stools available with plastic or felt glides. Chair also available with hard or soft casters. Chair and Stools available arm or armless. Chairs stack 5 high on the floor. -Wood-Leg Chair and Stools <ul style="list-style-type: none"> Chair and Stools available with plastic or felt glides. Chair and Stools available as armless only. Wood-Leg chair does not stack. -Four-Star Base Chair <ul style="list-style-type: none"> Fixed height chair. Stool not available. Available with plastic or felt glides. Seat swivels 360°. -Five-Star Base Chair <ul style="list-style-type: none"> Height adjustable chair. Stool not available. Available with hard or soft casters. Available arm or armless. Tablet arm option available in painted MDF, Laminate or Wood.

Maari

General Specifications

General Guidelines for Product Specification

	<u>S</u>	<u>7</u>	<u>S</u> - <u>2</u>	<u>4</u> - <u>1</u>	<u>H</u>	<u>R</u>	<u>L</u>
Product Type	_____						
(S) Seating	_____						
Product Line	_____						
(7) Maari - Standard Back	_____						
(8) Maari - Low Back	_____						
Model	_____						
Chairs	_____						
(H) Sled Base	_____						
(S) Four-Leg	_____						
(W) Wood-Leg	_____						
(4) 4-Star Base	_____						
(5) 5-Star Base	_____						
Stools	_____						
(HC) Sled Base - Counter Height	_____						
(HB) Sled Base - Bar Height	_____						
(SC) Four-Leg - Counter Height	_____						
(SB) Four-Leg - Bar Height	_____						
(WC) Wood-Leg - Counter Height	_____						
(WB) Wood-Leg - Bar Height	_____						
Seat Material	_____						
(1) Leather	_____						
(2) Fabric	_____						
(3) Faux Leather	_____						
(4) Polymer	_____						
Back Material	_____						
(1) Leather	_____						
(2) Fabric	_____						
(3) Faux Leather	_____						
(4) Polymer	_____						
Arms	_____						
(0) No Arms	_____						
(1) Fixed Arms, Hard Caps	_____						
Base/Caster	_____						
(H) Plastic Glides (Sled Base, Four-Leg, Wood-Leg, 4-Star chairs and all stools)	_____						
(K) Felt Glides (Sled Base, Four-Leg, Wood-Leg, 4-Star chairs and all stools)	_____						
(1) Hard Casters (Four-Leg and 5-Star chairs) - Black, Smooth Plaster	_____						
(2) Soft Casters (Four-Leg and 5-Star chairs) - Black only	_____						
(T) Two-Tone Caster (Four-Leg chair)	_____						
Tablet Handedness (if applicable - 5 Star base only)	_____						
(R) Right Hand	_____						
(L) Left Hand	_____						
Tablet Surface (if applicable)	_____						
(P) Painted MDF	_____						
(L) Laminate	_____						
(W) Wood	_____						

Maari

Sled Base Chair

With Arms



S7H-44-1H



S7H-24-1H



S7H-22-1H

Dimensions

- *SH: 18"(457mm)
- H: 33.75"(857mm)
- D: 21.75"(552mm)
- W: 25.25"(641mm)
- *SW: 18.5"(470mm)
- *SD: 16.75"(425mm)
- *AH: 8.5"(216mm)
- Between Arms: 22"(559mm)

* All measurements taken with the BIFMA chair measuring device.

Features

- Seat: High-strength polymer shell with optional upholstered seat pad.
- Back: High-strength polymer shell with optional upholstered back pad.
- Base: Available painted or chrome.
- Arm caps: Polypropylene.
- Glides: Plastic or felt.
- Stacks 5 high on the floor and 8 high upholstered or 16 high non-upholstered on the Very wire stacker cart.
- COM yardage / COL square footage:
Seat: 0.75/6.75
Back: 0.75/6.75

Specification Tip

- To stack on cart, use Very wire stacker cart.

To Order, Specify:

1) Product number, including:

1 Seat Surface:

- 1 Leather
- 2 Fabric
- 3 Faux Leather
- 4 Polymer

2 Back Surface:

- 1 Leather
- 2 Fabric
- 3 Faux Leather
- 4 Polymer

3 Glide Option:

- H Plastic Glides
- K Felt Glides

- 2) Shell color (required for upholstered and non-upholstered).
- 3) Seat upholstery and color (if applicable).
- 4) Back upholstery and color (if applicable).
- 5) Base trim color.
Add **\$60.69** list for Smooth Plaster & Matte finish.
- 6) Trim color for arm caps.

Number 1 2 3	Price	Fabric Grade										Leather Grade A	Leather Grade B
		A	B	C	D	E	F	G	H				
Without Optional Upholstered Pad													
S7H- 4 4 -1	\$401.70	N/A	N/A	N/A	N/A	N/A	N/A	N/A	N/A	N/A	N/A	N/A	N/A
With Upholstered Seat Pad													
S7H- 4 -1	N/A	\$525.30	\$542.81	\$551.05	\$569.59	\$581.95	\$638.60	\$674.65	\$ 733.36	\$644.78	\$ 794.13		
With Upholstered Seat and Back Pad													
S7H- -1	N/A	\$648.90	\$683.92	\$700.40	\$737.48	\$762.20	\$875.50	\$947.60	\$1065.02	\$887.86	\$1186.56		

The following options require modification of the product number.

Stain repellent

To specify, add **P** to the end of the product number; **Example:** S7H-24-1HP (add **\$41.20** list)

NOTE: Stain repellent is available on fabric surfaces only.

Maari

Sled Base Chair

Without Arms



S7H-44-0H



S7H-24-0H



S7H-22-0H

Dimensions

- *SH: 18"(457mm)
- H: 33.75"(857mm)
- D: 21.75"(552mm)
- W: 22"(559mm)
- *SW: 18.5"(470mm)
- *SD: 16.75"(425mm)

* All measurements taken with the BIFMA chair measuring device.

Features

- Seat: High-strength polymer shell with optional upholstered seat pad.
- Back: High-strength polymer shell with optional upholstered back pad.
- Base: Available painted or chrome.
- Glides: Plastic or felt.
- Stacks 5 high on the floor and 8 high upholstered or 16 high non-upholstered on the Very wire stacker cart.
- COM yardage / COL square footage:
Seat: 0.75/6.75
Back: 0.75/6.75

Specification Tip

- To stack on cart, use Very wire stacker cart.

To Order, Specify:

- 1) Product number, including:

1 Seat Surface:

- 1 Leather
- 2 Fabric
- 3 Faux Leather
- 4 Polymer

2 Back Surface:

- 1 Leather
- 2 Fabric
- 3 Faux Leather
- 4 Polymer

3 Glide Option:

- H Plastic Glides
- K Felt Glides

- 2) Shell color (required for upholstered and non-upholstered).
- 3) Seat upholstery and color (if applicable).
- 4) Back upholstery and color (if applicable).
- 5) Base trim color.
Add **\$60.69** list for Smooth Plaster & Matte finish.

Number 1 2 3	Price	Fabric Grade								Leather Grade A	Leather Grade B	
		A	B	C	D	E	F	G	H			
Without Optional Upholstered Pad												
S7H- 4 4 -0	\$334.75	N/A	N/A	N/A	N/A	N/A	N/A	N/A	N/A	N/A	N/A	N/A
With Upholstered Seat Pad												
S7H- 4 -0	N/A	\$458.35	\$475.86	\$484.10	\$502.64	\$515.00	\$571.65	\$607.70	\$666.41	\$577.83	\$ 727.18	
With Upholstered Seat and Back Pad												
S7H- -0	N/A	\$581.95	\$616.97	\$633.45	\$670.53	\$695.25	\$808.55	\$880.65	\$998.07	\$820.91	\$1119.61	

The following options require modification of the product number.

Stain repellent

To specify, add **P** to the end of the product number; **Example:** S7H-24-0HP (add **\$41.20** list)

NOTE: Stain repellent is available on fabric surfaces only.

Maari

Four-Leg Chair

With Arms



S7S-44-11



S7S-24-11



S7S-22-11

Dimensions

- *SH: 18"(457mm)
- H: 33"(838mm)
- D: 21.5"(546mm)
- W: 25.5"(648mm)
- *SW: 18.5"(470mm)
- *SD: 16.75"(425mm)
- *AH: 8.5"(216mm)
- Between Arms: 21.8"(554mm)

* All measurements taken with the BIFMA chair measuring device.

Features

- Seat: High-strength polymer shell with optional upholstered seat pad.
- Back: High-strength polymer shell with optional upholstered back pad.
- Arm caps: Polypropylene.
- Base: Four-Leg base available with glides or casters.
- Glides: Plastic or felt.
- Casters: Hard casters available in Black or Smooth Plaster. Color received is determined by frame color. Soft casters available in Black only. Exception: Specified Two-Tone casters in Fog.
- Stacks 5 high on the floor.
- COM yardage / COL square footage:
Seat: 0.75/6.75
Back: 0.75/6.75

To Order, Specify:

1) Product number, including:

1 Seat Surface:

- 1 Leather
- 2 Fabric
- 3 Faux Leather
- 4 Polymer

2 Back Surface:

- 1 Leather
- 2 Fabric
- 3 Faux Leather
- 4 Polymer

3 Glide or Caster Option:

- H Plastic Glides
- K Felt Glides
- 1 Hard Casters, add **\$41.20** list
- 2 Soft Casters, add **\$87.55** list
- T Two-Tone Casters, add **\$41.20** list

- 2) Shell color (required for upholstered and non-upholstered).
- 3) Seat upholstery and color (if applicable).
- 4) Back upholstery and color (if applicable).
- 5) Base trim color. Add **\$60.69** list for Smooth Plaster & Matte finish.
- 6) Trim color for arm caps.

Number 1 2 3	Price	Fabric Grade		C	D	E	F	G	H	Leather Grade A	Leather Grade B
		A	B								
Without Optional Upholstered Pad											
S7S- 4 4 -1	\$412.00	N/A	N/A	N/A	N/A	N/A	N/A	N/A	N/A	N/A	N/A
With Upholstered Seat Pad											
S7S- 4 -1	N/A	\$535.60	\$553.11	\$561.35	\$579.89	\$592.25	\$648.90	\$684.95	\$ 743.66	\$655.08	\$ 804.43
With Upholstered Seat and Back Pad											
S7S- -1	N/A	\$659.20	\$694.22	\$710.70	\$747.78	\$772.50	\$885.80	\$957.90	\$1075.32	\$898.16	\$1196.86

The following options require modification of the product number.

Stain repellent

To specify, add **P** to the end of the product number; **Example:** S7S-24-1HP (add **\$41.20** list)

NOTE: Stain repellent is available on fabric surfaces only.

Maari

Four-Leg Chair

Without Arms



S7S-44-0H



S7S-24-0H



S7S-22-0H

Dimensions

- *SH: 18"(457mm)
- H: 33"(838mm)
- D: 21.5"(546mm)
- W: 23"(584mm)
- *SW: 18.5"(470mm)
- *SD: 16.75"(425mm)

* All measurements taken with the BIFMA chair measuring device.

Features

- Seat: High-strength polymer shell with optional upholstered seat pad.
- Back: High-strength polymer shell with optional upholstered back pad.
- Base: Four-Leg base available with glides or casters.
- Glides: Plastic or felt.
- Casters: Hard casters available in Black or Smooth Plaster. Color received is determined by frame color. Soft casters available in Black only. Exception: Specified Two-Tone casters in Fog.
- Stack 5 high on the floor.
- COM yardage / COL square footage:
Seat: 0.75/6.75
Back: 0.75/6.75

To Order, Specify:

1) Product number, including:

1 Seat Surface:

- 1 Leather
- 2 Fabric
- 3 Faux Leather
- 4 Polymer

2 Back Surface:

- 1 Leather
- 2 Fabric
- 3 Faux Leather
- 4 Polymer

3 Glide or Caster Option:

- H Plastic Glides
- K Felt Glides
- 1 Hard Casters, add **\$41.20** list
- 2 Soft Casters, add **\$87.55** list
- T Two-Tone Casters, add **\$41.20** list

- 2) Shell color (required for upholstered and non-upholstered).
- 3) Seat upholstery and color (if applicable).
- 4) Back upholstery and color (if applicable).
- 5) Base trim color. Add **\$60.69** list for Smooth Plaster & Matte finish.

Number 1 2 3	Price	Fabric Grade		C	D	E	F	G	H	Leather Grade A	Leather Grade B
		A	B								
Without Optional Upholstered Pad											
S7S- 4 4 -0	\$345.05	N/A	N/A	N/A	N/A	N/A	N/A	N/A	N/A	N/A	N/A
With Upholstered Seat Pad											
S7S- 4 -0	N/A	\$468.65	\$486.16	\$494.40	\$512.94	\$525.30	\$581.95	\$618.00	\$ 676.71	\$588.13	\$ 737.48
With Upholstered Seat and Back Pad											
S7S- -0	N/A	\$592.25	\$627.27	\$643.75	\$680.83	\$705.55	\$818.85	\$890.95	\$1008.37	\$831.21	\$1129.91

The following options require modification of the product number.

Stain repellent

To specify, add **P** to the end of the product number; **Example:** S7S-24-0HP (add **\$41.20** list)

NOTE: Stain repellent is available on fabric surfaces only.

Maari

Wood-Leg Chair

Without Arms



S7W-44-0H



S7W-24-0H



S7W-22-0H

Dimensions

- *SH: 18"(457mm)
- H: 34"(864mm)
- D: 21.5"(546mm)
- W: 19.5"(495mm)
- *SW: 18.5"(470mm)
- *SD: 16.75"(425mm)

* All measurements taken with the BIFMA chair measuring device.

Features

- Seat: High-strength polymer shell with optional upholstered seat pad.
- Back: High-strength polymer shell with optional upholstered back pad.
- Base: Four leg wooden base.
- Glides: Plastic or felt.
- Chair only available without arms.
- Wood-Leg Chair does not stack.
- COM yardage / COL square footage:
Seat: 0.75/6.75
Back: 0.75/6.75

To Order, Specify:

1) Product number, including:

1 Seat Surface:

- 1 Leather
- 2 Fabric
- 3 Faux Leather
- 4 Polymer

2 Back Surface:

- 1 Leather
- 2 Fabric
- 3 Faux Leather
- 4 Polymer

3 Glide Option:

- H Plastic Glides
- K Felt Glides

- 2) Shell color (required for upholstered and non-upholstered).
- 3) Seat upholstery and color (if applicable).
- 4) Back upholstery and color (if applicable).
- 5) Wood finish.

Number 1 2 3	Price	Fabric Grade		C	D	E	F	G	H	Leather Grade A	Leather Grade B
		A	B								
Without Optional Upholstered Pad											
S7W- 4 4 -0	\$797.50	N/A	N/A	N/A	N/A	N/A	N/A	N/A	N/A	N/A	N/A
With Upholstered Seat Pad											
S7W- 4 4 -0	N/A	\$ 921.10	\$ 938.61	\$ 946.85	\$ 965.39	\$ 977.75	\$1034.40	\$1070.45	\$1129.16	\$1040.58	\$1189.93
With Upholstered Seat and Back Pad											
S7W- 4 4 -0	N/A	\$1044.70	\$1079.72	\$1096.20	\$1133.28	\$1158.00	\$1271.30	\$1343.40	\$1460.82	\$1283.66	\$1582.36

The following options require modification of the product number.

Stain repellent

To specify, add **P** to the end of the product number; **Example:** S7W-24-0HP (add \$41.20 list)

NOTE: Stain repellent is available on fabric surfaces only.

Maari

Four-Star Base Chair

With Arms



S74-44-1H



S74-24-1H



S74-22-1H

Dimensions

- *SH: 18"(457mm)
- H: 34"(864mm)
- D: 25.5"(648mm)
- W: 25.5"(648mm)
- *SW: 18.5"(470mm)
- *SD: 16.75"(425mm)
- *AH: 8.5"(216mm)
- Between Arms: 21.5"(546mm)

* All measurements taken with the BIFMA chair measuring device.

Features

- Seat: High-strength polymer shell with optional upholstered seat pad.
- Back: High-strength polymer shell with optional upholstered back pad.
- Arm caps: Polypropylene.
- Base: Fixed height four-star base with glides.
- Glides: Plastic or felt.
- Seat swivels 360°.
- COM yardage / COL square footage:
Seat: 0.75/6.75
Back: 0.75/6.75

To Order, Specify:

1) Product number, including:

1 Seat Surface:

- 1 Leather
- 2 Fabric
- 3 Faux Leather
- 4 Polymer

2 Back Surface:

- 1 Leather
- 2 Fabric
- 3 Faux Leather
- 4 Polymer

3 Glide Option:

- H Plastic Glides
- K Felt Glides

- 2) Shell color (required for upholstered and non-upholstered).
- 3) Seat upholstery and color (if applicable).
- 4) Back upholstery and color (if applicable).
- 5) Base trim color.
Add **\$60.69** list for Smooth Plaster & Matte finish.
- 6) Trim color for arm caps.

Number ① ② ③	Price	Fabric Grade							Leather Grade A	Leather Grade B
		A	B	C	D	E	F	G		
Without Optional Upholstered Pad										
S74- 4 4 -1	\$655.45	N/A	N/A	N/A	N/A	N/A	N/A	N/A	N/A	N/A
With Upholstered Seat Pad										
S74- 4 -1	N/A	\$779.05	\$796.56	\$804.80	\$823.34	\$ 835.70	\$ 892.35	\$ 928.40	\$ 987.11	\$ 898.53 \$1047.88
With Upholstered Seat and Back Pad										
S74- -1	N/A	\$902.65	\$937.67	\$954.15	\$991.23	\$1015.95	\$1129.25	\$1201.35	\$1318.77	\$1141.61 \$1440.31

The following options require modification of the product number.

Stain repellent

To specify, add **P** to the end of the product number; **Example:** S74-24-1HP (add **\$41.20** list)

NOTE: Stain repellent is available on fabric surfaces only.

Maari

Four-Star Base Chair

Without Arms



S74-44-0H



S74-24-0H



S74-22-0H

Dimensions

- *SH: 18"(457mm)
- H: 34"(864mm)
- D: 25.5"(648mm)
- W: 21.5"(546mm)
- *SW: 18.5"(470mm)
- *SD: 16.75"(425mm)

* All measurements taken with the BIFMA chair measuring device.

Features

- Seat: High-strength polymer shell with optional upholstered seat pad.
- Back: High-strength polymer shell with optional upholstered back pad.
- Base: Fixed height four-star base with glides.
- Glides: Plastic or felt.
- Seat swivels 360°.
- COM yardage / COL square footage:
Seat: 0.75/6.75
Back: 0.75/6.75

To Order, Specify:

1) Product number, including:

1 Seat Surface:

- 1 Leather
- 2 Fabric
- 3 Faux Leather
- 4 Polymer

2 Back Surface:

- 1 Leather
- 2 Fabric
- 3 Faux Leather
- 4 Polymer

3 Glide Option:

- H Plastic Glides
- K Felt Glides

- 2) Shell color (required for upholstered and non-upholstered).
- 3) Seat upholstery and color (if applicable).
- 4) Back upholstery and color (if applicable).
- 5) Base trim color.
Add **\$60.69** list for Smooth Plaster & Matte finish.

Number ① ② ③	Price	Fabric Grade								Leather Grade A	Leather Grade B	
		A	B	C	D	E	F	G	H			
Without Optional Upholstered Pad												
S74- 4 4 -0	\$588.50	N/A	N/A	N/A	N/A	N/A	N/A	N/A	N/A	N/A	N/A	N/A
With Upholstered Seat Pad												
S74- 4 -0	N/A	\$712.10	\$729.61	\$737.85	\$756.39	\$768.75	\$ 825.40	\$ 861.45	\$ 920.16	\$ 831.58	\$ 980.93	
With Upholstered Seat and Back Pad												
S74- -0	N/A	\$835.70	\$870.72	\$887.20	\$924.28	\$949.00	\$1062.30	\$1134.40	\$1251.82	\$1074.66	\$1373.36	

The following options require modification of the product number.

Stain repellent

To specify, add **P** to the end of the product number; **Example:** S74-24-0HP (add **\$41.20** list)

NOTE: Stain repellent is available on fabric surfaces only.

Maari

Five-Star Base Chair

Note: The prices reflect current April 2022 pricing.

With Arms



S75-44-11



S75-24-11



S75-22-11

Dimensions

- *SH: 16"-21"
(406mm-533mm)
- H: 32"(813mm)
- D: 28.5"(724mm)
- W: 28.5"(724mm)
- *SW: 18.5"(470mm)
- *SD: 16.75"(425mm)
- *AH: 8.5"(216mm)
- Between Arms: 22"(559mm)

* All measurements taken with the BIFMA chair measuring device.

Features

- Seat: High-strength polymer shell with optional upholstered seat pad.
- Back: High-strength polymer shell with optional upholstered back pad.
- Base: Five-star height adjustable base with casters.
- Height adjustment range: 16"(406mm)-21"(533mm)
- Arm caps: Polypropylene.
- Casters: Hard casters will be color matched to the base. Soft casters available in Black only.
- Tablet option:
 - Tablet arm available right or left handed.
 - Dual-pivot tablet rotates 360° at both the arm's pivot joint and tablet surface connection point.
 - Tablet surface is 11.5"(292mm)D x 19"(483mm)W and 0.75"(19mm) thick.
 - Tablet surface available in painted MDF, laminate and wood in White Oak or Walnut.
- COM yardage / COL square footage:
 - Seat: 0.75/6.75
 - Back: 0.75/6.75

Specification Tips

- Tablet arm handedness can be changed in the field; however, tablet option cannot be added or removed in the field.
- Pivot arm/tablet will need to be field installed to the support arm.

To Order, Specify:

1) Product number, including:

1 Seat Surface:

- 1 Leather
- 2 Fabric
- 3 Faux Leather
- 4 Polymer

2 Back Surface:

- 1 Leather
- 2 Fabric
- 3 Faux Leather
- 4 Polymer

3 Caster Option:

- 1 Hard Casters
- 2 Soft Casters, add **\$46.35** list

4 Tablet Option (if applicable):

- R Right Hand
- L Left Hand

- 2) Shell color (required for upholstered and non-upholstered).
- 3) Seat upholstery and color (if applicable).
- 4) Back upholstery and color (if applicable).
- 5) Base trim color.
Add **\$60.69** list for Smooth Plaster & Matte finish.
- 6) Trim color for arm caps.
- 7) Tablet surface color (if applicable).
- 8) Tablet arm trim color (if applicable).
TR-F Black
TR-M1 Black Matte
TR-PLS Smooth Plaster
TR-M2 Smooth Plaster Matte

Tablet Description	Number				Price	Fabric Grade								Leather Grade A	Leather Grade B
	1	2	3	4		A	B	C	D	E	F	G	H		
Polymer Shell Without Optional Upholstered Pad															
No Tablet	S75-	4	4	-1	\$ 696.29	N/A	N/A	N/A	N/A	N/A	N/A	N/A	N/A	N/A	
Painted MDF	S75-	4	4	-1	1261.29	N/A	N/A	N/A	N/A	N/A	N/A	N/A	N/A	N/A	
Laminate - Grade A	S75-	4	4	-1	1371.29	N/A	N/A	N/A	N/A	N/A	N/A	N/A	N/A	N/A	
Laminate - Grade B	S75-	4	4	-1	1384.29	N/A	N/A	N/A	N/A	N/A	N/A	N/A	N/A	N/A	
Wood- White Oak	S75-	4	4	-1	2031.29	N/A	N/A	N/A	N/A	N/A	N/A	N/A	N/A	N/A	
Wood - Walnut	S75-	4	4	-1	2086.29	N/A	N/A	N/A	N/A	N/A	N/A	N/A	N/A	N/A	
Polymer Shell With Upholstered Seat Pad															
No Tablet	S75-	4	4	-1	N/A	\$ 829.97	\$ 848.91	\$ 857.82	\$ 877.88	\$ 891.25	\$ 952.53	\$ 991.51	\$1055.02	\$ 959.20	\$1120.75
Painted MDF	S75-	4	4	-1	N/A	1394.97	1413.91	1422.82	1442.88	1456.25	1517.53	1556.51	1620.02	1524.20	1685.75
Laminate - Grade A	S75-	4	4	-1	N/A	1504.97	1523.91	1532.82	1552.88	1566.25	1627.53	1666.51	1730.02	1634.20	1795.75
Laminate - Grade B	S75-	4	4	-1	N/A	1517.97	1536.91	1545.82	1565.88	1579.25	1640.53	1679.51	1743.02	1647.20	1808.75
Wood- White Oak	S75-	4	4	-1	N/A	2164.97	2183.91	2192.82	2212.88	2226.25	2287.53	2326.51	2390.02	2294.20	2455.75
Wood - Walnut	S75-	4	4	-1	N/A	2219.97	2238.91	2247.82	2267.88	2281.25	2342.53	2381.51	2445.02	2349.20	2510.75
Polymer Shell With Upholstered Seat and Back Pads															
No Tablet	S75-	4	4	-1	N/A	\$ 963.65	\$1001.53	\$1019.35	\$1059.47	\$1086.21	\$1208.77	\$1286.73	\$1413.75	\$1222.11	\$1545.21
Painted MDF	S75-	4	4	-1	N/A	1528.65	1566.53	1584.35	1624.47	1651.21	1773.77	1851.73	1978.75	1787.11	2110.21
Laminate - Grade A	S75-	4	4	-1	N/A	1638.65	1676.53	1694.35	1734.47	1761.21	1883.77	1961.73	2088.75	1897.11	2220.21
Laminate - Grade B	S75-	4	4	-1	N/A	1651.65	1689.53	1707.35	1747.47	1774.21	1896.77	1974.73	2101.75	1910.11	2233.21
Wood- White Oak	S75-	4	4	-1	N/A	2298.65	2336.53	2354.35	2394.47	2421.21	2543.77	2621.73	2748.75	2557.11	2880.21
Wood - Walnut	S75-	4	4	-1	N/A	2353.65	2391.53	2409.35	2449.47	2476.21	2598.77	2676.73	2803.75	2612.11	2935.21

Note: The prices reflect current April 2022 pricing.

Maari
Five-Star Base Chair

Without Arms



S75-44-01



S75-24-01



S75-22-01

Dimensions

- *SH: 16"-21"
(406mm-533mm)
- H: 32"(813mm)
- D: 28.5"(724mm)
- W: 28.5"(724mm)
- *SW: 18.5"(470mm)
- *SD: 16.75"(425mm)

* All measurements taken with the BIFMA chair measuring device.

Features

- Seat: High-strength polymer shell with optional upholstered seat pad.
- Back: High-strength polymer shell with optional upholstered back pad.
- Base: Five-star height adjustable base with casters.
- Height adjustment range: 16"(406mm)-21"(533mm)
- Casters: Hard casters will be color matched to the base. Soft casters available in Black only.
- Tablet option:
 - Tablet arm available right or left handed.
 - Dual-pivot tablet rotates 360° at both the arm's pivot joint and tablet surface connection point.
 - Tablet surface is 11.5"(292mm)D x 19"(483mm)W and 0.75"(19mm) thick.
 - Tablet surface available in painted MDF, laminate and wood in White Oak or Walnut.
- COM yardage / COL square footage:
 - Seat: 0.75/6.75
 - Back: 0.75/6.75

Specification Tips

- Tablet arm handedness can be changed in the field; however, tablet option cannot be added or removed in the field.
- Pivot arm/tablet will need to be field installed to the support arm.

To Order, Specify:

1) Product number, including:

1 Seat Surface:

- 1 Leather
- 2 Fabric
- 3 Faux Leather
- 4 Polymer

2 Back Surface:

- 1 Leather
- 2 Fabric
- 3 Faux Leather
- 4 Polymer

3 Caster Option:

- 1 Hard Casters
- 2 Soft Casters, add **\$46.35** list

4 Tablet Option (if applicable):

- R Right Hand
- L Left Hand

- 2) Shell color (required for upholstered and non-upholstered).
- 3) Seat upholstery and color (if applicable).
- 4) Back upholstery and color (if applicable).
- 5) Base trim color.
Add **\$60.69** list for Smooth Plaster & Matte finish.
- 6) Tablet surface color (if applicable).
- 7) Tablet arm trim color (if applicable).
TR-F Black
TR-M1 Black Matte
TR-PLS Smooth Plaster
TR-M2 Smooth Plaster Matte

Tablet Description	Number	Price				Fabric Grade								Leather Grade A	Leather Grade B
		1	2	3	4	A	B	C	D	E	F	G	H		
Polymer Shell Without Optional Upholstered Pad															
No Tablet	S75-	4	4	-0	\$ 623.87	N/A	N/A	N/A	N/A	N/A	N/A	N/A	N/A	N/A	N/A
Painted MDF	S75-	4	4	-0	1188.87	N/A	N/A	N/A	N/A	N/A	N/A	N/A	N/A	N/A	N/A
Laminate - Grade A	S75-	4	4	-0	1298.87	N/A	N/A	N/A	N/A	N/A	N/A	N/A	N/A	N/A	N/A
Laminate - Grade B	S75-	4	4	-0	1311.87	N/A	N/A	N/A	N/A	N/A	N/A	N/A	N/A	N/A	N/A
Wood - White Oak	S75-	4	4	-0	1958.87	N/A	N/A	N/A	N/A	N/A	N/A	N/A	N/A	N/A	N/A
Wood - Walnut	S75-	4	4	-0	2013.87	N/A	N/A	N/A	N/A	N/A	N/A	N/A	N/A	N/A	N/A
Polymer Shell With Upholstered Seat Pad															
No Tablet	S75-	4	4	-0	N/A	\$ 757.55	\$ 776.49	\$ 785.40	\$ 805.46	\$ 818.83	\$ 880.11	\$ 919.09	\$ 982.60	\$ 886.78	\$ 1048.33
Painted MDF	S75-	4	4	-0	N/A	1322.55	1341.49	1350.40	1370.46	1383.83	1445.11	1484.09	1547.60	1451.78	1613.33
Laminate - Grade A	S75-	4	4	-0	N/A	1432.55	1451.49	1460.40	1480.46	1493.83	1555.11	1594.09	1657.60	1561.78	1723.33
Laminate - Grade B	S75-	4	4	-0	N/A	1445.55	1464.49	1473.40	1493.46	1506.83	1568.11	1607.09	1670.60	1574.78	1736.33
Wood - White Oak	S75-	4	4	-0	N/A	2092.55	2111.49	2120.40	2140.46	2153.83	2215.11	2254.09	2317.60	2221.78	2383.33
Wood - Walnut	S75-	4	4	-0	N/A	2147.55	2166.49	2175.40	2195.46	2208.83	2270.11	2309.09	2372.60	2276.78	2438.33
Polymer Shell With Upholstered Seat and Back Pads															
No Tablet	S75-	4	4	-0	N/A	\$ 891.23	\$ 929.11	\$ 946.93	\$ 987.05	\$ 1013.79	\$ 1136.35	\$ 1214.31	\$ 1341.33	\$ 1149.69	\$ 1472.79
Painted MDF	S75-	4	4	-0	N/A	1456.23	1494.11	1511.93	1552.05	1578.79	1701.35	1779.31	1906.33	1714.69	2037.79
Laminate - Grade A	S75-	4	4	-0	N/A	1566.23	1604.11	1621.93	1662.05	1688.79	1811.35	1889.31	2016.33	1824.69	2147.79
Laminate - Grade B	S75-	4	4	-0	N/A	1579.23	1617.11	1634.93	1675.05	1701.79	1824.35	1902.31	2029.33	1837.69	2160.79
Wood - White Oak	S75-	4	4	-0	N/A	2226.23	2264.11	2281.93	2322.05	2348.79	2471.35	2549.31	2676.33	2484.69	2807.79
Wood - Walnut	S75-	4	4	-0	N/A	2281.23	2319.11	2336.93	2377.05	2403.79	2526.35	2604.31	2731.33	2539.69	2862.79

Maari

Sled Base Stool

Standard Back

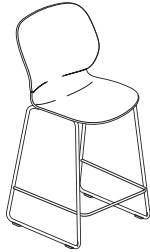

S7HB-44-0H
S7HC-44-0H



S7HB-24-0H
S7HC-24-0H



S7HB-22-0H
S7HC-22-0H

Dimensions

*SH: 30"(762mm)
Bar Height
26"(660mm)
Counter Height
H: 45.5"(1156mm)
Bar Height
41.5"(1054mm)
Counter Height
D: 23"(584mm)
W: 23"(584mm)
*SW: 18.5"(470mm)
*SD: 16.75"(425mm)

* All measurements taken with the BIFMA chair measuring device.

Features

- Seat: High-strength polymer shell with optional upholstered seat pad.
- Back: High-strength polymer shell with optional upholstered back pad.
- Base: Sled base available in bar height or counter height.
- Glides: Plastic or felt.
- Available without arms only.
- COM yardage / COL square footage:
Seat: 0.75/6.75
Back: 0.75/6.75

To Order, Specify:

1) Product number, including:

1 Seat Surface:

- 1 Leather
- 2 Fabric
- 3 Faux Leather
- 4 Polymer

2 Back Surface:

- 1 Leather
- 2 Fabric
- 3 Faux Leather
- 4 Polymer

3 Glide Option:

- H Plastic Glides
- K Felt Glides

- 2) Shell color (required for upholstered and non-upholstered).
- 3) Seat upholstery and color (if applicable).
- 4) Back upholstery and color (if applicable).
- 5) Base trim color.
Add **\$60.69** list for Smooth Plaster & Matte finish.

Description	Number 1 2 3	Price	Fabric Grade		C	D	E	F	G	H	Leather Grade A	Leather Grade B
			A	B								
Without Optional Upholstered Pad												
Bar Height	S7HB- 4 4 -0	\$517.06	N/A	N/A	N/A	N/A	N/A	N/A	N/A	N/A	N/A	N/A
Counter Height	S7HC- 4 4 -0	517.06	N/A	N/A	N/A	N/A	N/A	N/A	N/A	N/A	N/A	N/A
With Upholstered Seat Pad												
Bar Height	S7HB- 4 4 -0	N/A	\$640.66	\$658.17	\$666.41	\$684.95	\$697.31	\$753.96	\$ 790.01	\$ 848.72	\$ 760.14	\$ 909.49
Counter Height	S7HC- 4 4 -0	N/A	640.66	658.17	666.41	684.95	697.31	753.96	790.01	848.72	760.14	909.49
With Upholstered Seat and Back Pad												
Bar Height	S7HB- 4 4 -0	N/A	\$764.26	\$799.28	\$815.76	\$852.84	\$877.56	\$990.86	\$1062.96	\$1180.38	\$1003.22	\$1301.92
Counter Height	S7HC- 4 4 -0	N/A	764.26	799.28	815.76	852.84	877.56	990.86	1062.96	1180.38	1003.22	1301.92

The following options require modification of the product number.

Stain repellent

To specify, add **P** to the end of the product number; **Example:** S7HB-24-0HP (add **\$41.20** list)

NOTE: Stain repellent is available on fabric surfaces only.

Maari

Sled Base Stool

Low Back

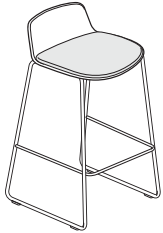

S8HB-24-0H
S8HC-24-0H

Dimensions

- *SH: 30"(762mm)
- Bar Height 26"(660mm)
- Counter Height H: 35.25"(895mm)
- Bar Height 31.25"(794mm)
- Counter Height D: 23"(584mm)
- W: 23"(584mm)
- *SW: 18.5"(470mm)
- *SD: 16.75"(425mm)

* All measurements taken with the BIFMA chair measuring device.

Features

- Seat: High-strength polymer shell with or without upholstered seat pad.
- Back: High-strength low back polymer shell.
- Base: Available in bar height or counter height.
- Glides: Plastic or felt.
- Available without arms only.
- COM yardage / COL square footage: Seat: 0.75/6.75

To Order, Specify:

1) Product number, including:

1 Seat Surface:

- 1** Leather
- 2** Fabric
- 3** Faux Leather
- 4** Polymer

2 Glide Option:

- H** Plastic Glides
- K** Felt Glides

- 2) Shell color.
- 3) Seat upholstery and color (if applicable).
- 4) Base trim color. Add **\$60.69** list for Smooth Plaster & Matte finish.

Description	Number		Price	Fabric Grade		C	D	E	F	G	H	Leather Grade A	Leather Grade B
	1	2		A	B								
Without Upholstered Seat Pad													
Bar Height	S8HB-	44 -0	\$491.31	N/A	N/A	N/A	N/A	N/A	N/A	N/A	N/A	N/A	N/A
Counter Height	S8HC-	44 -0	491.31	N/A	N/A	N/A	N/A	N/A	N/A	N/A	N/A	N/A	N/A
With Upholstered Seat Pad													
Bar Height	S8HB-	4 -0	N/A	\$614.91	\$632.42	\$640.66	\$659.20	\$671.56	\$728.21	\$764.26	\$822.97	\$734.39	\$883.74
Counter Height	S8HC-	4 -0	N/A	614.91	632.42	640.66	659.20	671.56	728.21	764.26	822.97	734.39	883.74

The following options require modification of the product number.

Stain repellent

To specify, add **P** to the end of the product number; **Example:** S8HB-24-0HP (add **\$41.20** list)

NOTE: Stain repellent is available on fabric surfaces only.

Maari

Four-Leg Stool

With Arms

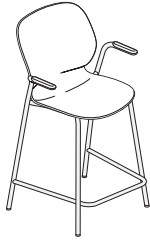

S75B-44-1H
S75C-44-1H



S75B-24-1H
S75C-24-1H

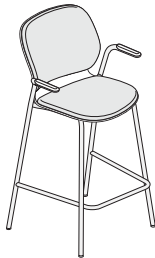

S75B-22-1H
S75C-22-1H

Dimensions

- *SH: 30"(762mm)
Bar Height
26"(660mm)
Counter Height
- H: 45.5"(1156mm)
Bar Height
41.5"(1054mm)
Counter Height
- D: 23"(584mm)
- W: 23"(584mm)
- *SW: 18.5"(470mm)
- *SD: 16.75"(425mm)
- *AH: 8.5"(216mm)

* All measurements taken with the BIFMA chair measuring device.

Features

- Seat: High-strength polymer shell with optional upholstered seat pad.
- Back: High-strength polymer shell with optional upholstered back pad.
- Arm caps: Polypropylene.
- Base: Four-Leg available in bar height or counter height.
- Glides: Plastic or felt.
- COM yardage / COL square footage:
Seat: 0.75/6.75
Back: 0.75/6.75

To Order, Specify:

1) Product number, including:

1 Seat Surface:

- 1 Leather
- 2 Fabric
- 3 Faux Leather
- 4 Polymer

2 Back Surface:

- 1 Leather
- 2 Fabric
- 3 Faux Leather
- 4 Polymer

3 Glide Option:

- H Plastic Glides
- K Felt Glides

- 2) Shell color (required for upholstered and non-upholstered).
- 3) Seat upholstery and color (if applicable).
- 4) Back upholstery and color (if applicable).
- 5) Base trim color.
Add **\$60.69** list for Smooth Plaster & Matte finish.
- 6) Color for arm caps.

Description	Number			Price	Fabric Grade								Leather Grade A	Leather Grade B
	1	2	3		A	B	C	D	E	F	G	H		
Without Optional Upholstered Pad														
Bar Height	S75B-	4	4 -1	\$659.20	N/A	N/A	N/A	N/A	N/A	N/A	N/A	N/A	N/A	N/A
Counter Height	S75C-	4	4 -1	659.20	N/A	N/A	N/A	N/A	N/A	N/A	N/A	N/A	N/A	N/A
With Upholstered Seat Pad														
Bar Height	S75B-	4	-1	N/A	\$782.80	\$800.31	\$808.55	\$827.09	\$ 839.45	\$ 896.10	\$ 932.15	\$ 990.86	\$ 902.28	\$1051.63
Counter Height	S75C-	4	-1	N/A	782.80	800.31	808.55	827.09	839.45	896.10	932.15	990.86	902.28	1051.63
With Upholstered Seat and Back Pad														
Bar Height	S75B-	-1		N/A	\$906.40	\$941.42	\$957.90	\$994.98	\$1019.70	\$1133.00	\$1205.10	\$1322.52	\$1145.36	\$1444.06
Counter Height	S75C-	-1		N/A	906.40	941.42	957.90	994.98	1019.70	1133.00	1205.10	1322.52	1145.36	1444.06

The following options require modification of the product number.

Stain repellent

To specify, add **P** to the end of the product number; **Example:** S75B-24-1HP (add **\$41.20** list)

NOTE: Stain repellent is available on fabric surfaces only.

Maari

Four-Leg Stool

Without Arms

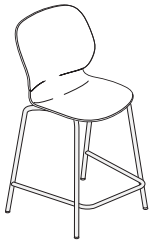

S7SB-44-0H
S7SC-44-0H



S7SB-24-0H
S7SC-24-0H

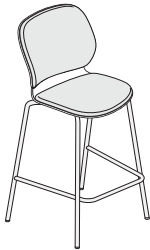

S7SB-22-0H
S7SC-22-0H

Dimensions

- *SH: 30"(762mm)
Bar Height
26"(660mm)
Counter Height
- H: 45.5"(1156mm)
Bar Height
41.5"(1054mm)
Counter Height
- D: 23"(584mm)
- W: 23"(584mm)
- *SW: 18.5"(470mm)
- *SD: 16.75"(425mm)

* All measurements taken with the BIFMA chair measuring device.

Features

- Seat: High-strength polymer shell with optional upholstered seat pad.
- Back: High-strength polymer shell with optional upholstered back pad.
- Base: Four-Leg available in bar height or counter height.
- Glides: Plastic or felt.
- COM yardage / COL square footage:
Seat: 0.75/6.75
Back: 0.75/6.75

To Order, Specify:

1) Product number, including:

1 Seat Surface:

- 1 Leather
- 2 Fabric
- 3 Faux Leather
- 4 Polymer

2 Back Surface:

- 1 Leather
- 2 Fabric
- 3 Faux Leather
- 4 Polymer

3 Glide Option:

- H Plastic Glides
- K Felt Glides

- 2) Shell color (required for upholstered and non-upholstered).
- 3) Seat upholstery and color (if applicable).
- 4) Back upholstery and color (if applicable).
- 5) Base trim color.
Add **\$60.69** list for Smooth Plaster & Matte finish.

Description	Number ① ② ③	Price	Fabric Grade								Leather Grade A	Leather Grade B	
			A	B	C	D	E	F	G	H			
Without Optional Upholstered Pad													
Bar Height	S7SB- 4 4 -0	\$592.25	N/A	N/A	N/A	N/A	N/A	N/A	N/A	N/A	N/A	N/A	N/A
Counter Height	S7SC- 4 4 -0	592.25	N/A	N/A	N/A	N/A	N/A	N/A	N/A	N/A	N/A	N/A	N/A
With Upholstered Seat Pad													
Bar Height	S7SB- 4 -0	N/A	\$715.85	\$733.36	\$741.60	\$760.14	\$772.50	\$ 829.15	\$ 865.20	\$ 923.91	\$ 835.33	\$ 984.68	
Counter Height	S7SC- 4 -0	N/A	715.85	733.36	741.60	760.14	772.50	829.15	865.20	923.91	835.33	984.68	
With Upholstered Seat and Back Pad													
Bar Height	S7SB- -0	N/A	\$839.45	\$874.47	\$890.95	\$928.03	\$952.75	\$1066.05	\$1138.15	\$1255.57	\$1078.41	\$1377.11	
Counter Height	S7SC- -0	N/A	839.45	874.47	890.95	928.03	952.75	1066.05	1138.15	1255.57	1078.41	1377.11	

The following options require modification of the product number.

Stain repellent

To specify, add **P** to the end of the product number; **Example:** S7SB-24-0HP (add **\$41.20** list)

NOTE: Stain repellent is available on fabric surfaces only.

Maari

Wood-Leg Stool

Standard Back



S7WB-44-0H
S7WC-44-0H



S7WB-24-0H
S7WC-24-0H



S7WB-22-0H
S7WC-22-0H

Dimensions

- *SH: 30"(762mm)
Bar Height
26"(660mm)
Counter Height
- H: 45.5"(1156mm)
Bar Height
41.5"(1054mm)
Counter Height
- D: 23"(584mm)
- W: 23"(584mm)
- *SW: 18.5"(470mm)
- *SD: 16.75"(425mm)

* All measurements taken with the BIFMA chair measuring device.

Features

- Seat: High-strength polymer shell with optional upholstered seat pad.
- Back: High-strength polymer shell with optional upholstered back pad.
- Base: Wood leg available in bar height or counter height.
- Glides: Plastic or felt.
- Available without arms only.
- Foot ring available in black or chrome.
- COM yardage / COL square footage:
Seat: 0.75/6.75
Back: 0.75/6.75

To Order, Specify:

1) Product number, including:

1 Seat Surface:

- 1 Leather
- 2 Fabric
- 3 Faux Leather
- 4 Polymer

2 Back Surface:

- 1 Leather
- 2 Fabric
- 3 Faux Leather
- 4 Polymer

3 Glide Option:

- H Plastic Glides
- K Felt Glides

- 2) Shell color (required for upholstered and non-upholstered).
- 3) Seat upholstery and color (if applicable).
- 4) Back upholstery and color (if applicable).
- 5) Wood finish.
- 6) Foot ring finish.
TR-F Black
KR-V Chrome, add **\$100.00** list

Description	Number	Price	Fabric Grade								Leather Grade A	Leather Grade B	
			1	2	3	A	B	C	D	E			F
Without Optional Upholstered Pad													
Bar Height	S7WB- 4 4 -0	\$1265.00											
Counter Height	S7WC- 4 4 -0	1265.00											
With Upholstered Seat Pad													
Bar Height	S7WB- 4 4 -0	N/A	\$1388.60	\$1406.11	\$1414.35	\$1432.89	\$1445.25	\$1501.90	\$1537.95	\$1596.66	\$1508.08	\$1657.43	
Counter Height	S7WC- 4 4 -0	N/A	1388.60	1406.11	1414.35	1432.89	1445.25	1501.90	1537.95	1596.66	1508.08	1657.43	
With Upholstered Seat and Back Pad													
Bar Height	S7WB- 4 4 -0	N/A	\$1512.20	\$1547.22	\$1563.70	\$1600.78	\$1625.50	\$1738.80	\$1810.90	\$1928.32	\$1751.16	\$2049.86	
Counter Height	S7WC- 4 4 -0	N/A	1512.20	1547.22	1563.70	1600.78	1625.50	1738.80	1810.90	1928.32	1751.16	2049.86	

The following options require modification of the product number.

Stain repellent

To specify, add **P** to the end of the product number; **Example:** S7WB-24-0HP (add **\$41.20** list)

NOTE: Stain repellent is available on fabric surfaces only.

Maari

Wood-Leg Stool

Low Back



S8WB-24-0H
S8WC-24-0H

Dimensions

- *SH: 30"(762mm)
Bar Height
26"(660mm)
Counter Height
- H: 35.25"(895mm)
Bar Height
31.25"(794mm)
Counter Height
- D: 23"(584mm)
W: 23"(584mm)
- *SW: 18.5"(470mm)
- *SD: 16.75"(425mm)

* All measurements taken with the BIFMA chair measuring device.

Features

- Seat: High-strength polymer shell with upholstered seat pad.
- Back: High-strength low back polymer shell.
- Base: Available in bar height or counter height.
- Foot ring available in black or chrome.
- Glides: Plastic or felt.
- Available without arms only.
- COM yardage / COL square footage:
Seat: 0.75/6.75

To Order, Specify:

1) Product number, including:

1 Seat Surface:

- 1 Leather
- 2 Fabric
- 3 Faux Leather

2 Glide Option:

- H Plastic Glides
- K Felt Glides

- 2) Shell color.
- 3) Seat upholstery and color
- 4) Wood finish.
- 5) Foot ring finish.
TR-F Black
KR-V Chrome, add **\$100.00** list

Description	Number		Fabric Grade								Leather Grade A	Leather Grade B
	1	2	A	B	C	D	E	F	G	H		
With Upholstered Seat Pad												
Bar Height	S8WB-	4 -0	\$1361.10	\$1378.61	\$1386.85	\$1405.39	\$1417.75	\$1474.40	\$1510.45	\$1569.16	\$1480.58	\$1629.93
Counter Height	S8WC-	4 -0	1361.10	1378.61	1386.85	1405.39	1417.75	1474.40	1510.45	1569.16	1480.58	1629.93

The following options require modification of the product number.

Stain repellent

To specify, add **P** to the end of the product number; **Example:** S8WB-24-0HP (add **\$41.20** list)

NOTE: Stain repellent is available on fabric surfaces only.

This page intentionally blank

Wood Seating

General Specifications

Features and Options

Guest and occasional models feature frames constructed solid hardwood, laminated plywood, laminated hardwood core and premium veneers, or rigid polyurethane.

Office seating models feature an inner frame construction of tubular steel or solid hardwood or laminated plywood or molded plywood. Swivel bases are standard with hard dual-wheel casters.

Exposed wood surfaces are finished with two top coats of pre-catalyst nitrocellulose lacquer for a durable finish.

Refer to the appropriate seating model for applicable features and options.

COM & COL General Information

To order a COM fabric (Customer's Own Material), contact the Haworth Inquiry Center (1.800.426.8562), your local Haworth dealer, or go to haworth.com/surfaces > COM Library to find out if the COM you have selected has already been tested and approved. The surface collection site also has information on the Haworth + alliance program with Carnegie, Luna Textiles, and Maharam as well as our industry-leading Pre-Approved COM program.

COM fabrics are placed into Grades based on the cost per linear yard. If a fabric's cost exceeds the range of our highest Grade it will be noted as Non-Graded. The product will be priced at Grade A; the COM fabric costs will appear as a separate line item. The fabric charge will be Haworth's purchase cost plus a 4% administrative fee (based on the cost of the fabric). Yardage calculations will include any applicable fabric repeat.

COM Leather products will be priced at a leather Grade A; COL costs will appear as a separate line item. The leather costs will be Haworth's purchase cost plus a 4% administrative fee (based on the cost of the leather).

General Guidelines for Product Specification

Seating specification numbers are based on a numeric logic that identifies a product by model and certain characteristics.

For instance, a product number that reads **SAS-22-A1A** identifies the product as a Candor Modern Seating with fully upholstered seat and back.

The numeric logic for this model with finish codes is shown below:

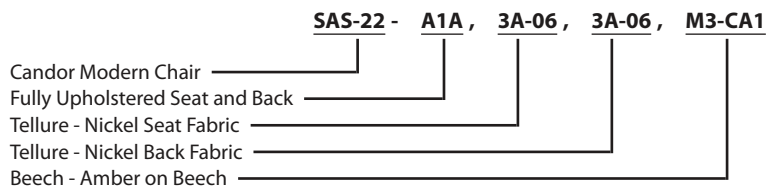

A ninth-digit suffix of the product code will indicate functional options, such as **-F** for CAL 133 option. There are exceptions to this logic; therefore, always refer to the price charts for product numbers rather than attempting to construct them. Product number modification instructions for additional options appear in footnoted copy for each applicable model.

Beyond the printed product number, fabric and finish codes are required to complete an order specification.

To communicate your order clearly, list the product number and finish codes in the sequence outlined on each price page.

Finishes and Fabrics

A complete listing of finishes/fabrics can be found in the back of the price list.

Candor Modern Seating

Guest/Occasional Seating

Number ① ②	Fabric Grade		C	D	E	F	G	H	Leather Grade A	Leather Grade B
	A	B								
SAS- ■ ■ -A1A	\$1121.35	\$1151.45	\$1163.51	\$1193.59	\$1211.63	\$1419.39	\$1479.59	\$1660.17	\$1524.75	\$1884.01

Fully Upholstered Seat and Back



SAS-22-A1A

Dimensions

SH: 17.8"(452mm)
H: 32.75"(832mm)
D: 23.50"(597mm)
W: 21"(533mm)
SD: 17"(432mm)
SW: 17.8"(452mm)
AH: 25"(635mm)

Features

- Open arms.
- Upholstered seat and back.
- Steamed beech hardwood frame. Seat frame rails are mortise and tenoned, cross locked with dowels, reinforced with corner blocks.
- Seat is HR foam over a webbed panel.
- The upholstered back frame insert is padded with foam.
- COM yardage: 1.5
- COL square footage: 27.0

To Order, Specify:

1) Product number, including:

① Seat Option:

- 1 Leather
- 2 Fabric
- 3 Faux Leather

② Back Option:

- 1 Leather
- 2 Fabric
- 3 Faux Leather

- 2) Fabric surface and color (seat).
- 3) Fabric surface and color (back).
- 4) Arm/frame finish color.

SAS- ■ ■ -A3A	\$1121.35	\$1151.45	\$1163.51	\$1193.59	\$1211.63	\$1419.39	\$1479.59	\$1660.17	\$1524.75	\$1884.01
---------------	-----------	-----------	-----------	-----------	-----------	-----------	-----------	-----------	-----------	-----------

Fully Upholstered Seat and 1/2 Back



SAS-22-A3A

Dimensions

SH: 17.8"(452mm)
H: 32.50"(826mm)
D: 23"(584mm)
W: 21"(533mm)
SD: 17"(432mm)
SW: 17.8"(452mm)
AH: 25"(635mm)

Features

- Open arms.
- Upholstered seat and back.
- Steamed beech hardwood frame. Seat frame rails are mortise and tenoned, cross locked with dowels, reinforced with corner blocks.
- Seat is HR foam over a webbed panel.
- The upholstered back frame insert is padded with foam.
- COM yardage: 1.25
- COL square footage: 22.5

To Order, Specify:

1) Product number, including:

① Seat Option:

- 1 Leather
- 2 Fabric
- 3 Faux Leather

② Back Option:

- 1 Leather
- 2 Fabric
- 3 Faux Leather

- 2) Fabric surface and color (seat).
- 3) Fabric surface and color (back).
- 4) Arm/frame finish color.

The following options require modification of the product number.

Stain Repellent

Moisture Barrier with Stain Repellent

To specify, add **-P** to the end of the product number; **Example:** SAS-22-A1A-**P** (add **\$46.66** list)

To specify, add **-D** to the end of the product number; **Example:** SAS-22-A1A-**D** (add **\$61.70** list)

NOTE: For available fabrics, refer to surfaces.haworth.com.

Composites Seating Series

Guest/Occasional Seating

Base/ Frame	Number	Fabric Grade		C	D	E	F	G	H	Leather Grade A	Leather Grade B
		A	B								
Maple	4045-00	\$1432.89	\$1482.56	\$1527.70	\$1602.97	\$1648.12	\$1676.72	\$1729.39	\$1875.39	\$2409.74	\$2644.18

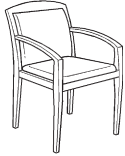
**Arc Arm,
Upholstered Back**

4045-00

Dimensions

SH: 18.5"(470mm)
 H: 33.75"(857mm)
 D: 23"(584mm)
 W: 22.375"(568mm)
 SD: 18"(457mm)
 SW: 19.5"(495mm)
 AH: 24" - 26"
 (610mm-660mm)

Features

- Open arms.
- Upholstered seat and back.
- Maple hardwood frame. Seat frame rails are mortise and tenoned, cross locked with dowels, reinforced with corner blocks.
- Seat is HR foam over a webbed panel.
- The upholstered back frame insert is webbed and padded with foam.
- Available with fire-retardant construction to comply with California Bulletin #133.
- COM yardage: 1.25
- COL square footage: 22.5

To Order, Specify:

- 1) Product number.
- 2) Fabric surface and color.
- 3) Arm/frame finish color.

Maple	4049-00	\$1432.89	\$1482.56	\$1527.70	\$1602.97	\$1648.12	\$1676.72	\$1729.39	\$1875.39	\$2409.74	\$2644.18
-------	---------	-----------	-----------	-----------	-----------	-----------	-----------	-----------	-----------	-----------	-----------

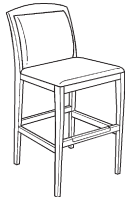
**Stool, Armless,
Upholstered Back**

4049-00

Dimensions

SH: 28"(711mm)
 H: 41.125"(1045mm)
 D: 19.875"(505mm)
 W: 18.5"(470mm)
 SW: 18.5"(470mm)
 SD: 15.25"(387mm)

Features

- Upholstered seat and back.
- Maple hardwood frame. Seat frame rails are mortise and tenoned, cross locked with dowels, reinforced with corner blocks.
- Seat is HR foam over a webbed panel.
- The upholstered back frame insert is webbed and padded with foam.
- Standard with brass kick plate. No finish specification required.
- Available with fire-retardant construction to comply with California Bulletin #133.
- COM yardage: 1.00
- COL square footage: 18.0

To Order, Specify:

- 1) Product number.
- 2) Fabric surface and color.
- 3) Frame finish color.

The following options require modification of the product number.

Stain Repellent

Moisture Barrier with Stain Repellent

To specify, add **-P** to the end of the product number; **Example:** 4049-00-**P** (add **\$46.66** list)To specify, add **-D** to the end of the product number; **Example:** 4049-00-**D** (add **\$61.70** list)**NOTE:** Stain repellent and moisture barrier are not available on leather or faux leather.For available fabrics, refer to surfaces.haworth.com.

Forenze Seating

Guest/Occasional Seating

Base/ Frame	Number	Fabric Grade		C	D	E	F	G	H	Leather Grade A	Leather Grade B
		A	B								
Maple	8484-00	\$1538.25	\$1566.84	\$1578.88	\$1608.98	\$1630.06	\$1782.09	\$1834.77	\$1980.78	\$1950.66	\$2146.00

**Cabriole Arm,
Slat Back**



Dimensions

- SH: 18.25"(464mm)
- H: 32.625"(829mm)
- D: 22.75"(578mm)
- W: 22.75"(578mm)
- SD: 18.625"(473mm)
- SW: 19.5"(495mm)
- AH: 26.5"(673mm)

Features

- Open arms.
- Upholstered seat.
- Maple hardwood frame. Seat frame rails are mortise and tenoned, cross locked with dowels.
- Seat is 1.75"(44mm) HR foam over a webbed panel.
- COM yardage: 1.75
- COL square footage: 13.5

To Order, Specify:

- 1) Product number.
- 2) Fabric surface and color.
- 3) Wood finish color.

8484-00

Maple	8184-00	\$1538.25	\$1586.41	\$1630.05	\$1700.79	\$1745.96	\$1845.30	\$1910.02	\$2000.00	\$2468.45	\$2717.99
-------	---------	-----------	-----------	-----------	-----------	-----------	-----------	-----------	-----------	-----------	-----------

**Cabriole Arm,
Upholstered Back**



Dimensions

- SH: 18.25"(464mm)
- H: 32.625"(829mm)
- D: 22.75"(578mm)
- W: 22.75"(578mm)
- SD: 18.625"(473mm)
- SW: 19.5"(495mm)
- AH: 26.5"(673mm)

Features

- Open arms.
- Upholstered seat and back.
- Maple hardwood frame. Seat frame rails are mortise and tenoned, cross locked with dowels.
- Seat is 1.75"(44mm) HR foam over a webbed panel.
- The upholstered back frame insert is webbed and padded with 1"(25mm) thick foam.
- COM yardage: 1.25
- COL square footage: 22.5

To Order, Specify:

- 1) Product number.
- 2) Fabric surface and color.
- 3) Wood finish color.

8184-00

The following options require modification of the product number.

Stain Repellent

Moisture Barrier with Stain Repellent

To specify, add **-P** to the end of the product number; **Example:** 8484-00-**P** (add **\$46.66** list)

To specify, add **-D** to the end of the product number; **Example:** 8484-00-**D** (add **\$61.70** list)

NOTE: Stain repellent and moisture barrier are not available on leather or faux leather.

For availability of these options, refer to surfaces.haworth.com.



OBSOLETE! September 2022

Riverbend and Pebble

Environmental Factors BIFMA Level 2 Certified
Greenguard / Greenguard Gold Certified.

Fabrics and Finishes A complete listing of fabrics and finishes for Riverbend and Pebble is available in the back of the price list. Fabric is applied Railroaded to both Riverbend and Pebble products. Linear or patterned fabric is not recommended due to the manner in which fabric is applied. Material will not be pattern matched.

Riverbend sofas and Pebble ottomans feature large, flat surfaces, and textile crispness will be influenced by the amount of stretch in each textile. Some textiles will stretch more than others, resulting in a small amount of pooling. This can be addressed by running a hand across the surface to smooth the material.

Stain Repellent To specify add "P" to end of the product number.
Example: SMSN-2028-HNFP

General Guidelines for Product Specification

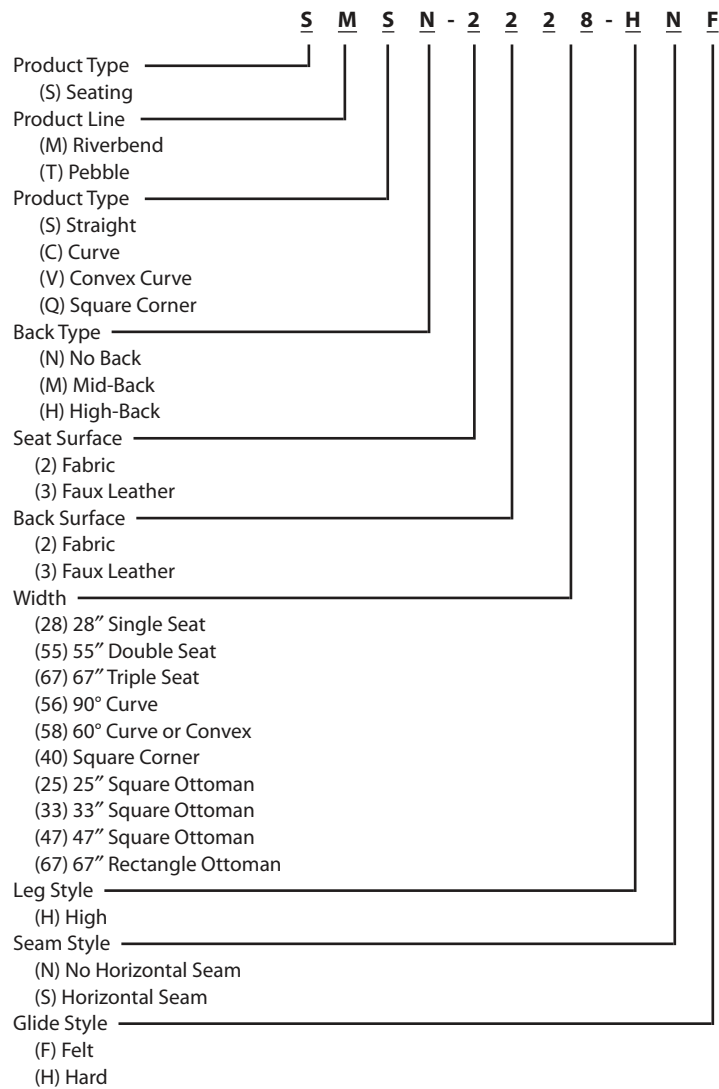

Riverbend and Pebble

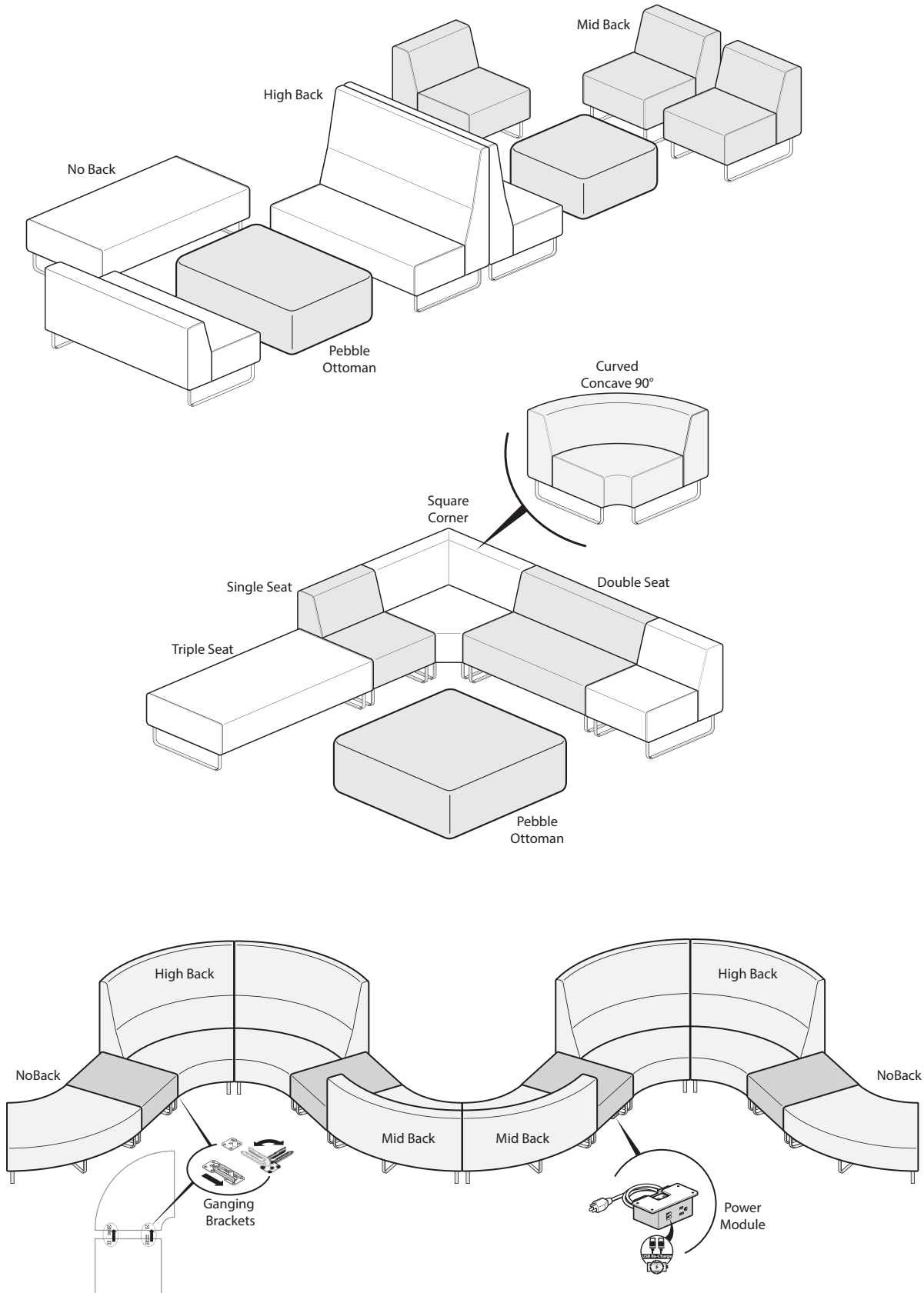

Riverbend and Pebble

Seam Options

No Horizontal Seam

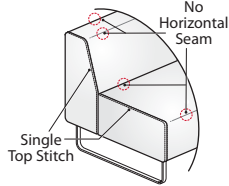

Horizontal Seam

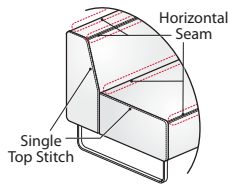

Riverbend units are available with and without a double-needle stitch horizontal seam.

When specified without horizontal seams, textiles will gently flow over the front and back edges of the seat and back, providing a simple and seamless aesthetic.

For a tailored aesthetic, Riverbend units can be specified with a horizontal seam along the front and back edges of the seat and back.

Ganging Bracket

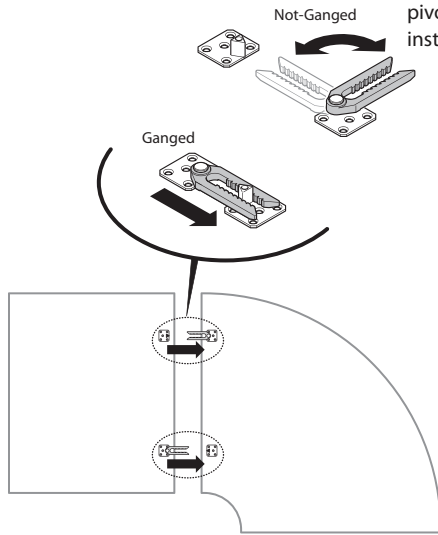

Ganging brackets are used to gang one Riverbend component to another. When not in use the ganging bracket pivots to hide under the seat. Each Ganging Bracket Kit includes two brackets, screws, a template and assembly instructions. One kit will gang two sofas together.

Power Module

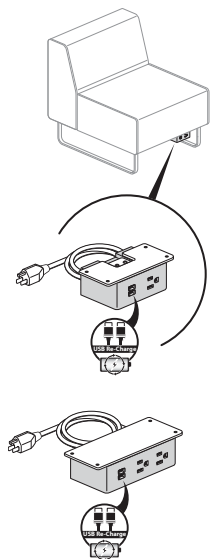

The separately specified power module provides under seat power consisting of either one or two simplex outlets (NEMA-5-15R) and one dual USB port. The Power Module must be installed along the front edge of the Riverbend seat. Power Modules may not be daisy chained together.

The Power Module is available either corded or hardwire with a 6' or 12' cord.

Included with the module are two cord management clips and attachment hardware.

Application may require approval from local authority having jurisdiction (AHJ); ensure compliance before placing orders and installing.



Riverbend and Pebble

General Specification

Single Seat

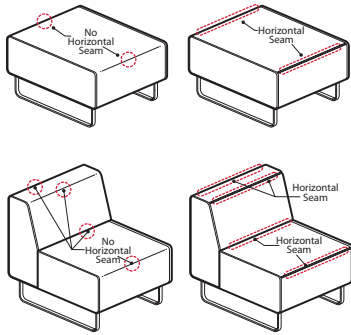

Features:

- Back Option: No Back, Mid-Back
- Available with horizontal seams or without horizontal seams. Horizontal seam location noted by red lines.
- Seat width 27.6"(701mm)
- Available with hard plastic or felt glides.
- Accepts separately specified power module for under seat power access.
- Use separately specified ganging bracket to connect components together.

Double Seat

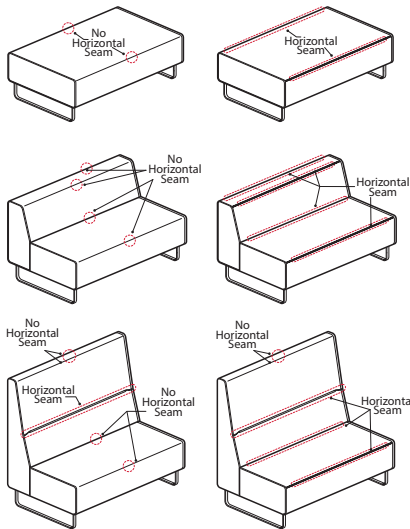

Features:

- Back Option: No Back, Mid-Back, High-Back
- Available with horizontal seams or without horizontal seams. Horizontal seam location noted by red lines.
- Seat width 55"(1397mm)
- Available with hard plastic or felt glides.
- Accepts separately specified power module for under seat power access.
- Use separately specified ganging bracket to connect components together.

Triple Seat

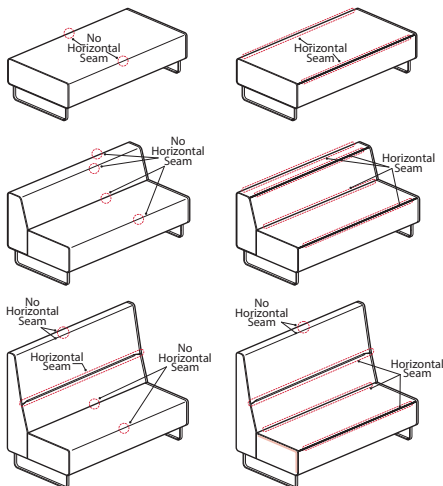

Features:

- Back Option: No Back, Mid-Back, High-Back
- Available with horizontal seams or without horizontal seams. Horizontal seam location noted by red lines.
- Seat width 67"(1702mm)
- Available with hard plastic or felt glides.
- Accepts separately specified power module for under seat power access.
- Use separately specified ganging bracket to connect components together.

Riverbend and Pebble

General Specification

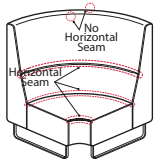
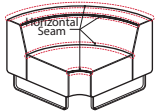
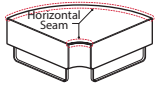
90° Curved – Concave**Features:**

- Back Option: No Back, Mid-Back, High-Back
- Available with horizontal seams only.
Horizontal seam placement noted in red.
- Available with hard plastic or felt glides.
- Accepts separately specified power module for under seat power access.
- Use separately specified ganging bracket to connect components together.

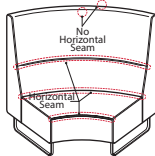
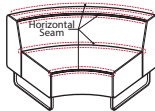
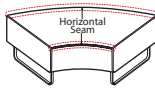
60° Curved – Concave**Features:**

- Back Option: No Back, Mid-Back, High-Back
- Available with horizontal seams only.
Horizontal seam placement noted in red.
- Available with hard plastic or felt glides.
- Accepts separately specified power module for under seat power access.
- Use separately specified ganging bracket to connect components together.

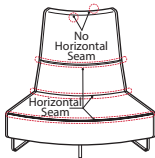
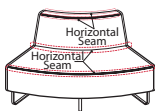
60° Curved – Convex**Features:**

- Back Option: Mid-Back, High-Back
 - For No Back option use 60° Curved – Concave.
- Available with horizontal seams only.
Horizontal seam placement noted in red.
- Available with hard plastic or felt glides.
- Accepts separately specified power module for under seat power access.
- Use separately specified ganging bracket to connect components together.

Riverbend and Pebble

General Specification

Square Corner

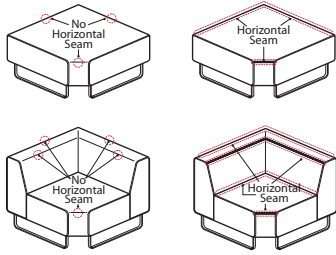

Features:

- Back Option: No Back, Mid-Back
- Available with horizontal seams or without horizontal seams. Horizontal seam location noted in red.
- Available with hard plastic or felt glides.
- Accepts separately specified power module for under seat power access.
- Use separately specified ganging bracket to connect components together.

Pebble Ottoman

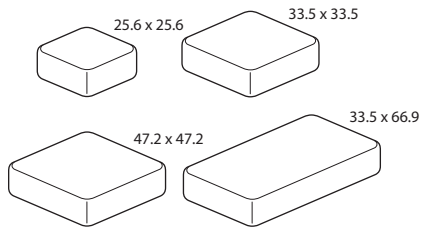

Features:

- Available in two shapes and four sizes.
 - Square - Small - 25.6"(650mm)
 - Square - Medium - 33.5"(851mm)
 - Square - Large - 47.2"(1199mm)
 - Rectangle - 66.9"(1699mm) W X 33.5"(851mm) D
- Available with hard plastic or felt glides.

Riverbend

Straight

Single Seat

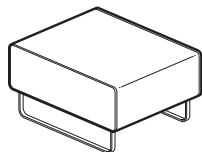

SMSN-2028-H

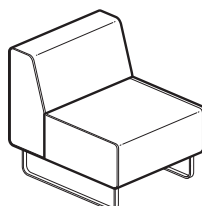

SMSM-2228-H

Dimensions

SH: 17.8"(452mm)
 TH: 17.8"(452mm) - No Back
 30.7"(780mm) - Mid-Back
 SD: 33.8"(858mm) - No Back
 22.6"(574mm) - Mid-Back
 TD: 33.8"(858mm)
 TW: 27.6"(701mm)

Features

- Includes upholstered seat and back (if applicable) and painted steel legs.
- Seat and back available in same surface and color or different surface and color.
- Available with hard plastic glides or felt glides.
- Available with or without horizontal seams. When ordering with horizontal seams there will be a seam across the front of the seat and across the top of the mid-back.
- COM yardage:
 No Back: 2.4
 Mid-Back: 4.25 (seat 2.1/back 2.1)

Specification Tips

- Fabric applied railroaded.
- Linear or patterned fabric not recommended due to the manner in which fabric is applied.
- Ganging bracket available (ordered separately) to attach adjacent Riverbend products.
- Separately specified power module available for under seat power access.
- When using with adjacent curved corner unit, specify with seam option to maintain a consistent seam line across the front of the entire configuration.
- For accent pillows, refer to Openest Price List.

To Order, Specify:

1) Product number, including:

1 Seat Surface:

- 2 Fabric
- 3 Faux Leather

2 Back Surface:

- 2 Fabric
- 3 Faux Leather

3 Glide Style:

- H Hard
- F Felt

- 2) Seat fabric surface and color.
- 3) Back fabric surface and color.
- 4) Trim color.

Note: For mixed grade surface materials, please refer to the electronic design and specification tools for pricing.

Description	Number			Fabric Grade							
	1	2	3	A	B	C	D	E	F	G	H
Without Horizontal Seams											
No Back	SMSN-	028-HN		\$1135.44	\$1233.88	\$1266.57	\$1311.08	\$1372.38	\$1662.63	\$1904.19	\$2180.89
Mid-Back	SMSM-	28-HN		1691.58	1861.79	1911.84	1990.58	2090.86	2579.54	2801.42	3200.90
With Horizontal Seams											
No Back	SMSN-	028-HS		\$1203.56	\$1302.00	\$1334.69	\$1379.20	\$1440.50	\$1730.75	\$1972.31	\$2249.01
Mid-Back	SMSM-	28-HS		1759.70	1929.91	1979.96	2058.70	2158.98	2647.66	2869.54	3269.02

The following options require modification of the product number.

Stain Repellent

To specify, add **P** to end of the product number; **Example:** SMSN-2028-HNFP
 (No Back - add \$65.81 list, Mid-Back - add \$113.24 list)

Riverbend

Straight

Double Seat

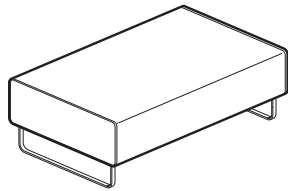

SMSN-2055-H

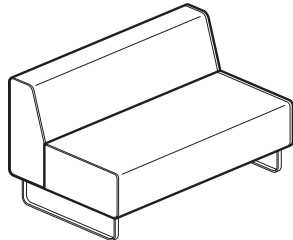

SMSM-2255-H

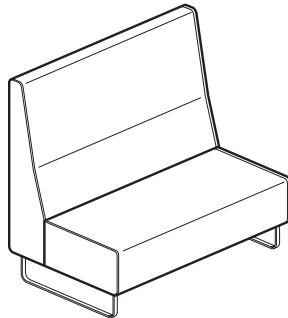

SMSH-2255-H

Dimensions

SH: 17.8"(452mm)
 TH: 17.8"(452mm) -
 No Back
 30.7"(780mm) -
 Mid-Back
 49.6"(1260mm) -
 High-Back
 SD: 33.8"(858mm) -
 No Back
 22.6(574mm) -
 Mid-Back
 22.6"(574mm) -
 High-Back
 TD: 33.8"(858mm)
 TW: 55"(1397mm)

Features

- Includes upholstered seat and back (if applicable) and painted steel legs.
- Seat and back available in same surface and color or different surface and color.
- Available with hard plastic glides or felt glides.
- Available with or without horizontal seams. When ordering with horizontal seams there will be a seam across the front of the seat and across the top of the mid-back.
- COM yardage:
 No Back: 4.2
 Mid-Back: 7.2 (seat 4.2/back 3.0)
 High-Back: 9.4 (seat 4.2/back 5.2)

Specification Tips

- Fabric applied railroaded.
- Linear or patterned fabric not recommended due to the manner in which fabric is applied.
- Ganging bracket available (ordered separately) to attach adjacent Riverbend products.
- Separately specified power module available for under seat power access.
- When using with adjacent curved corner unit, specify with seam option to maintain a consistent seam line across the front of the entire configuration.
- For accent pillows, refer to Openest Price List.

To Order, Specify:

1) Product number, including:

1 Seat Surface:

- 2 Fabric
- 3 Faux Leather

2 Back Surface:

- 2 Fabric
- 3 Faux Leather

3 Glide Style:

- H Hard
- F Felt

- 2) Seat fabric surface and color.
- 3) Back fabric surface and color.
- 4) Trim color.

Note: For mixed grade surface materials, please refer to the electronic design and specification tools for pricing.

Description	Number			Fabric Grade							
	1	2	3	A	B	C	D	E	F	G	H
Without Horizontal Seams											
No Back	SMSN-	055-HN		\$1872.31	\$2012.10	\$2058.24	\$2122.75	\$2209.05	\$2621.42	\$2808.71	\$3145.73
Mid-Back	SMSM-	55-HN		2428.45	2667.31	2746.13	2854.55	3006.25	3704.73	4023.75	4597.95
High-Back	SMSH-	55-HN		3094.64	3410.95	3515.75	3658.96	3857.50	4787.13	5210.16	5971.63
With Horizontal Seams											
No Back	SMSN-	055-HS		\$1940.43	\$2080.22	\$2126.36	\$2190.87	\$2277.17	\$2689.54	\$2876.83	\$3213.85
Mid-Back	SMSM-	55-HS		2496.57	2735.43	2814.25	2922.67	3074.37	3772.85	4091.87	4666.07
High-Back	SMSH-	55-HS		3162.76	3479.07	3583.87	3727.08	3925.62	4855.25	5278.28	6039.75

The following options require modification of the product number.

Stain Repellent

To specify, add **P** to end of the product number; **Example:** SMSN-2055-HNFP
 (No Back - add **\$93.27** list, Mid-Back - add **\$159.88** list, High-Back - add **\$213.18** list)

Riverbend

Straight

Triple Seat

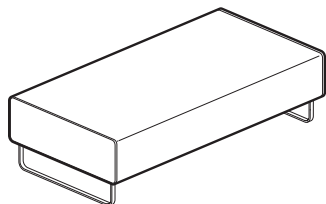

SMSN-2067-H

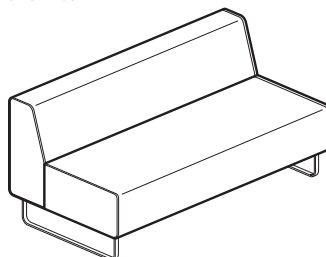

SMSM-2267-H

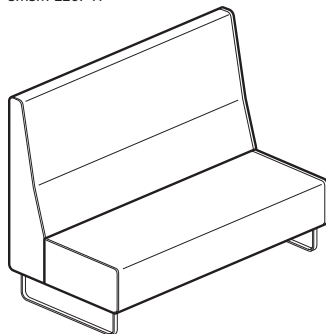

SMSH-2267-H

Dimensions

SH: 17.8"(452mm)
 TH: 17.8"(452mm) - No Back
 30.7"(780mm) - Mid-Back
 49.6"(1260mm) - High-Back
 SD: 33.8"(858mm) - No Back
 22.6"(574mm) - Mid-Back
 22.6"(574mm) - High-Back
 TD: 33.8"(858mm)
 TW: 67"(1702mm)

Features

- Includes upholstered seat and back (if applicable) and painted steel legs.
- Seat and back available in same surface and color or different surface and color.
- Available with hard plastic glides or felt glides.
- Available with or without horizontal seams. When ordering with horizontal seams there will be a seam across the front of the seat and across the top of the mid-back.
- COM yardage:
 No Back: 5.0
 Mid-Back: 8.5 (seat 5.0/back 3.5)
 High-Back: 11.4 (seat 5.0/back 6.4)

Specification Tips

- Fabric applied railroaded.
- Linear or patterned fabric not recommended due to the manner in which fabric is applied.
- Ganging bracket available (ordered separately) to attach adjacent Riverbend products.
- Separately specified power module available for under seat power access.
- When using with adjacent curved corner unit, specify with seam option to maintain a consistent seam line across the front of the entire configuration.
- For accent pillows, refer to Openest Price List.

To Order, Specify:

1) Product number, including:

1 Seat Surface:

- 2 Fabric
- 3 Faux Leather

2 Back Surface:

- 2 Fabric
- 3 Faux Leather

3 Glide Style:

- H Hard
- F Felt

- 2) Seat fabric surface and color.
- 3) Back fabric surface and color.
- 4) Trim color.

Note: For mixed grade surface materials, please refer to the electronic design and specification tools for pricing.

Description	Number			Fabric Grade							
	1	2	3	A	B	C	D	E	F	G	H
Without Horizontal Seams											
No Back	SMSN-	067-HN		\$2267.40	\$2428.18	\$2481.03	\$2554.62	\$2653.97	\$3127.51	\$3342.52	\$3729.50
Mid-Back	SMSM-	67-HN		2823.54	3103.12	3195.40	3324.42	3501.84	4321.76	4696.34	5582.62
High-Back	SMSH-	67-HN		3489.73	3867.75	3992.72	4166.88	4402.58	5515.14	6021.46	7294.23
With Horizontal Seams											
No Back	SMSN-	067-HS		\$2335.52	\$2496.30	\$2549.15	\$2622.74	\$2722.09	\$3195.63	\$3410.64	\$3797.62
Mid-Back	SMSM-	67-HS		2891.66	3171.24	3263.52	3392.54	3569.96	4389.88	4764.46	5650.74
High-Back	SMSH-	67-HS		3557.85	3935.87	4060.84	4235.00	4470.70	5583.26	6089.58	7362.35

The following options require modification of the product number.

Stain Repellent

To specify, add **P** to end of the product number; **Example:** SMSN-2067-HNFP
 (No Back - add \$106.59 list, Mid-Back - add \$186.53 list, High-Back - add \$253.16 list)

Riverbend

Curved — Concave

90°

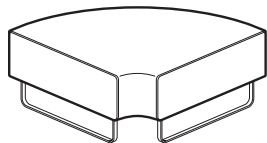

SMCN-2056-HS

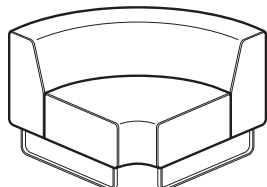

SMCM-2256-HS

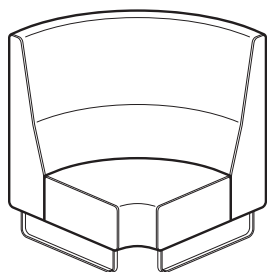

SMCH-2256-HS

Dimensions

SH: 17.8"(452mm)
 TH: 17.8"(452mm) -
 No Back
 30.7"(780mm) -
 Mid-Back
 49.6"(1260mm) -
 High-Back
 SD: 33.8"(858mm) -
 No Back
 22.6"(574mm) -
 Mid-Back
 22.6"(574mm) -
 High-Back
 TD: 33.8"(858mm)
 TW: 56.3"(1430mm)

Features

- Includes upholstered seat and back (if applicable) and painted steel legs.
- Seat and back available in same surface and color or different surface and color.
- Available with hard plastic glides or felt glides.
- Available with horizontal seam on seat front and back and across the top of the mid-back.
- COM yardage:
 No Back: 3.2
 Mid-Back: 6.1 (seat 2.75/back 3.35)
 High-Back: 7.25 (seat 2.75/back 4.5)

Specification Tips

- Fabric applied railroaded.
- Linear or patterned fabric not recommended due to the manner in which fabric is applied.
- Ganging bracket available (ordered separately) to attach adjacent Riverbend products.
- Separately specified power module available for under seat power access.
- For accent pillows, refer to Openest Price List.

To Order, Specify:

1) Product number, including:

1 Seat Surface:

- 2 Fabric
- 3 Faux Leather

2 Back Surface:

- 2 Fabric
- 3 Faux Leather

3 Glide Style:

- H Hard
- F Felt

- 2) Seat fabric surface and color.
- 3) Back fabric surface and color.
- 4) Trim color.

Note: For mixed grade surface materials, please refer to the electronic design and specification tools for pricing.

Description	Number			Fabric Grade							
	1	2	3	A	B	C	D	E	F	G	H
No Back	SMCN-	056-HS		\$2030.56	\$2154.99	\$2196.17	\$2252.49	\$2329.87	\$2696.45	\$2862.88	\$3162.46
Mid-Back	SMCM-	56-HS		2604.07	2873.40	2962.37	3085.94	3252.53	4046.84	4708.01	5465.35
High-Back	SMCH-	56-HS		3496.22	3823.03	3930.24	4079.54	4281.98	5244.18	5681.09	6467.52

The following options require modification of the product number.

Stain Repellent

To specify, add **P** to end of the product number; **Example:** SMCN-2056-HSFP
 (No Back - add **\$85.27** list, Mid-Back - add **\$179.88** list, High-Back - add **\$219.85** list)

Riverbend

Curved — Concave

60°

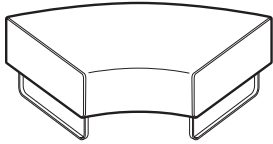

SMCN-2058-HS

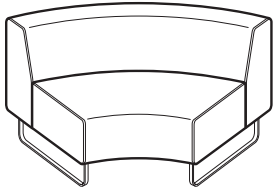

SMCM-2258-HS

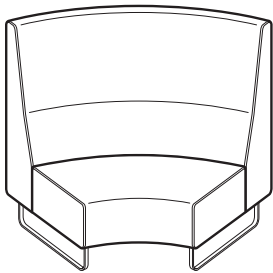

SMCH-2258-HS

Dimensions

SH: 17.8"(452mm)
 TH: 17.8"(452mm) -
 No Back
 30.7"(780mm) -
 Mid-Back
 49.6"(1260mm) -
 High-Back
 SD: 33.8"(858mm) -
 No Back
 22.6"(574mm) -
 Mid-Back
 22.6"(574mm) -
 High-Back
 TD: 33.8"(858mm)
 TW: 58.3"(1481mm)

Features

- Includes upholstered seat and back (if applicable) and painted steel legs.
- Seat and back available in same surface and color or different surface and color.
- Available with hard plastic glides or felt glides.
- Available with horizontal seam on seat front and back and across the top of the mid-back.
- COM yardage:
 No Back: 3.5
 Mid-Back: 7.0 (seat 3.0/back 4.0)
 High-Back: 8.1 (seat 3.0/back 5.1)

Specification Tips

- Fabric applied railroaded.
- Linear or patterned fabric not recommended due to the manner in which fabric is applied.
- Ganging bracket available (ordered separately) to attach adjacent Riverbend products.
- Separately specified power module available for under seat power access.
- For accent pillows, refer to Openest Price List.

To Order, Specify:

1) Product number, including:

1 Seat Surface:

- 2** Fabric
- 3** Faux Leather

2 Back Surface:

- 2** Fabric
- 3** Faux Leather

3 Glide Style:

- H** Hard
- F** Felt

- 2) Seat fabric surface and color.
- 3) Back fabric surface and color.
- 4) Trim color.

Note: For mixed grade surface materials, please refer to the electronic design and specification tools for pricing.

Description	Number			Fabric Grade							
	1	2	3	A	B	C	D	E	F	G	H
No Back	SMCN-	058-HS		\$2200.89	\$2345.93	\$2393.58	\$2460.20	\$2550.02	\$2977.75	\$3171.93	\$3521.45
Mid-Back	SMCM-	58-HS		2774.40	3059.86	3153.63	3283.55	3460.28	4300.37	4999.73	5800.70
High-Back	SMCH-	58-HS		3666.53	4008.45	4121.48	4277.14	4489.54	5497.73	5955.43	6779.25

The following options require modification of the product number.

Stain Repellent

To specify, add **P** to end of the product number; **Example:** SMCN-2058-HSFP
 (No Back - add \$99.93 list, Mid-Back - add \$193.20 list, High-Back - add \$226.51 list)

Riverbend

Curved — Convex

60° Convex

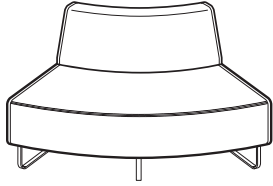

SMVM-2258-HS

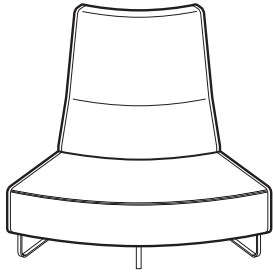

SMVH-2258-HS

Dimensions

SH: 17.8"(452mm)
 TH: 30.7"(780mm) -
 Mid-Back
 49.6"(1260mm) -
 High-Back
 SD: 22.6"(574mm)
 TD: 33.8"(858mm)
 TW: 58.3"(3780mm)

Features

- Includes upholstered seat and back (if applicable) and painted steel legs.
- Seat and back available in same surface and color or different surface and color.
- Available with hard plastic glides or felt glides.
- Convex shape available as 60° only.
- Available with horizontal seam on seat front and back and across the top of the mid-back.
- COM yardage:
 Mid-Back: 6.0 (seat 3.0/back 3.0)
 High-Back: 6.75 (seat 3.0/back 3.75)

Specification Tips

- Fabric applied railroaded.
- Linear or patterned fabric not recommended due to the manner in which fabric is applied.
- Ganging bracket available (ordered separately) to attach adjacent Riverbend products.
- Separately specified power module available for under seat power access.
- For no back version use 60° Curve Concave.
- For accent pillows, refer to Openest Price List.

To Order, Specify:

1) Product number, including:

1 Seat Surface:

- 2 Fabric
- 3 Faux Leather

2 Back Surface:

- 2 Fabric
- 3 Faux Leather

3 Glide Style:

- H Hard
- F Felt

- 2) Seat fabric surface and color.
- 3) Back fabric surface and color.
- 4) Trim color.

Note: For mixed grade surface materials, please refer to the electronic design and specification tools for pricing.

Description	Number			Fabric Grade							
	1	2	3	A	B	C	D	E	F	G	H
Mid-Back	SMVM-	58-HS		\$2810.32	\$3054.18	\$3134.77	\$3245.30	\$3396.48	\$4114.35	\$4440.30	\$5026.99
High-Back	SMVH-	58-HS		\$3702.44	\$3977.16	\$4068.15	\$4193.20	\$4363.36	\$5172.95	\$5540.46	\$6202.06

The following options require modification of the product number.

Stain Repellent

To specify, add **P** to end of the product number; **Example:** SMVM-2258-HSFP
 (Mid-Back - add \$166.54 list, High-Back - add \$186.53 list)

Riverbend

Corner — Square

Corner – Square

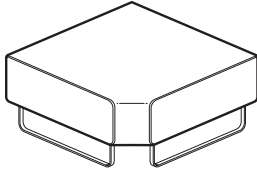

SMQN-2040-H

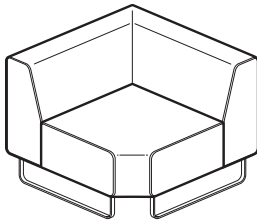

SMQM-2240-H

Dimensions

SH: 17.8”(452mm)
 TH: 17.8”(452mm)
 No Back
 30.7”(780mm) -
 Mid-Back
 SD: 33.8”(858mm)
 No Back
 22.6”(574mm) -
 Mid-Back
 TD: 33.8”(858mm)
 TW: 40”(1016mm)

Features

- Includes upholstered seat and back (if applicable) and painted steel legs.
- Seat and back available in same surface and color or different surface and color.
- Available with hard plastic glides or felt glides.
- Available with or without horizontal seams. When order with horizontal seams there will be a seam across the front of the seat and across the top of the mid-back.
- COM yardage:
 No Back: 4.0
 Mid-Back: 7.0 (seat 4.0/back 3.0)

Specification Tips

- Fabric applied railroaded.
- Linear or patterned fabric not recommended due to the manner in which fabric is applied.
- Ganging bracket available (ordered separately) to attach adjacent Riverbend products.
- Separately specified power module available for under seat power access.
- For accent pillows, refer to Openest Price List.
- **Big Arrow fabric available however will not be pattern matched. Available with horizontal seam only.**

To Order, Specify:

1) Product number, including:

1 Seat Surface:

- 2 Fabric
- 3 Faux Leather

2 Back Surface:

- 2 Fabric
- 3 Faux Leather

3 Glide Style:

- H Hard
- F Felt

- 2) Seat fabric surface and color.
- 3) Back fabric surface and color.
- 4) Trim color.

Note: For mixed grade surface materials, please refer to the electronic design and specification tools for pricing.

Description	Number		Fabric Grade								
	1	2	3	A	B	C	D	E	F	G	H
Without Horizontal Seams											
No Back	SMQN-	040-HN		\$2511.86	\$2637.43	\$2707.41	\$2842.76	\$2975.89	\$3422.21	\$3695.96	\$4213.33
Mid-Back	SMQM-	40-HN		3091.16	3369.34	3537.77	3785.40	3962.68	4675.88	5143.43	6017.76
With Horizontal Seams											
No Back	SMQN-	040-HS		\$2627.72	\$2753.29	\$2823.27	\$2958.62	\$3091.75	\$3538.07	\$3811.82	\$4329.19
Mid-Back	SMQM-	40-HS		3207.02	3485.20	3653.63	3901.26	4078.54	4791.74	5259.29	6133.62

The following options require modification of the product number.

Stain Repellent

To specify, add **P** to end of the product number; **Example:** SMQN-2040-HNFP
 (No Back - add \$71.39 list, Mid-Back - add \$154.23 list)

Pebble

Ottoman

Ottoman

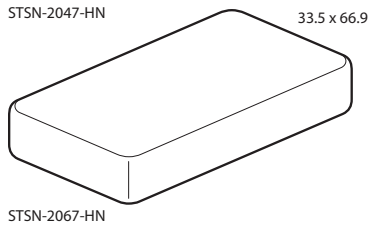
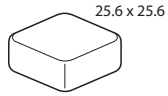

Features

- Includes one ottoman with glides.
- Glides available in hard plastic or felt.
- COM yardage:
 Square - Small: 3.0
 Square - Medium: 3.75
 Square - Large: 5.25
 Rectangle: 6.1

Specification Tips

- Fabric applied railroaded.
- Linear or patterned fabric not recommended due to the manner in which fabric is applied.

To Order, Specify:

1) Product number, including:

① Surface Material:

- ② Fabric
- ③ Faux Leather

② Glide Style:

- H Hard
- F Felt

2) Surface material and color.

Description	Height	Depth	Width	Number		Fabric Grade							
				①	②	A	B	C	D	E	F	G	H
Square - Small	16.9"(429mm)	25.6"(650mm)	25.6"(650mm)	STSN-025-HN		\$ 996.40	\$1112.68	\$1150.40	\$1203.61	\$1270.11	\$1606.64	\$1759.16	\$2033.70
Square - Medium		33.5"(851mm)	33.5"(851mm)	STSN-033-HN		1169.03	1319.14	1368.01	1436.71	1529.04	1973.22	2174.22	2536.03
Square - Large		47.2"(1199mm)	47.2"(1199mm)	STSN-047-HN		1966.15	2173.43	2241.79	2336.10	2462.91	3075.42	3352.68	3851.73
Rectangle		33.5"(851mm)	66.9"(1699mm)	STSN-067-HN		1946.46	2187.56	2267.09	2376.87	2529.53	3249.68	3846.90	4530.95

The following options require modification of the product number.

Stain Repellent

To specify, add **P** to end of the product number; **Example:** STSN-2025-HNFP

(Square - Small - add \$79.94 list, Square - Medium - add \$99.93 list, Square - Large - add \$139.90 list, Rectangle - add \$162.55 list)

Riverbend Accessories

Ganging Bracket

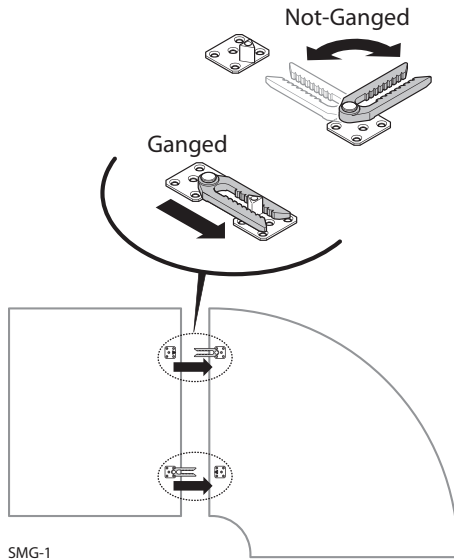

SMG-1

Features

- Includes 2 brackets, screws, assembly instructions and template.
- Available in black only.

Specification Tip

- Used to gang two Riverbend components together.

To Order, Specify:

- 1) Product number.
(No finish specification required.)

	Number	Price
	SMG-1	\$127.44

Riverbend Power Module

Corded

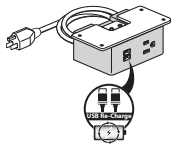

EUSM-PFOW-1100
EUSM-PLOW-1100

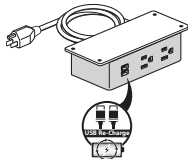

EUSM-PFOW-2100
EUSM-PLOW-2100



Features

- Includes power module, two cord management clips, mounting brackets and attachment hardware.
- Power module consists of either one or two simplex outlets (NEMA-5-15R) and one dual USB port.

Specification Tips

- Power module attaches to the front edge of the Riverbend components.
- Power modules cannot be daisy chained together.
- Application may require approval from local authority having jurisdiction (AHJ); ensure compliance before placing orders and installing.

To Order, Specify:

1) Product number, including:

1 Color:

B Black

W White

Description	Number ¹	Price
6' Cord		
One Simplex Outlet	EUSM-PFO ■ -1100	\$425.26
Two Simplex Outlets	EUSM-PFO ■ -2100	436.00
12' Cord		
One Simplex Outlet	EUSM-PL0 ■ -1100	\$457.54
Two Simplex Outlets	EUSM-PL0 ■ -2100	468.28

Hardwire

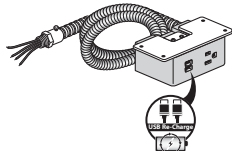

EUSM-HFOW-1100
EUSM-HLOW-1100

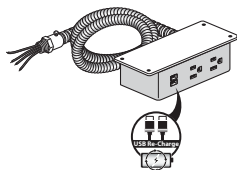

EUSM-HFOW-2100
EUSM-HLOW-2100



Features

- Includes power module, two cord management clips, mounting brackets and attachment hardware.
- Power module consists of either one or two simplex outlets (NEMA-5-15R) and one dual USB port.

Specification Tips

- Power module attaches to the front edge of the Riverbend components.
- Power modules cannot be daisy chained together.
- Application may require approval from local authority having jurisdiction (AHJ); ensure compliance before placing orders and installing.

To Order, Specify:

1) Product number, including:

1 Color:

B Black

W White

6' Cord		
One Simplex Outlet	EUSM-HFO ■ -1100	\$506.01
Two Simplex Outlets	EUSM-HFO ■ -2100	516.75
12' Cord		
One Simplex Outlet	EUSM-HLO ■ -1100	\$538.29
Two Simplex Outlets	EUSM-HLO ■ -2100	549.03

Openest Collection

Plume Screens

Plume 3

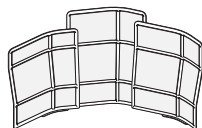

SON-3

Dimensions

H: 65"(1651mm)
 D: 34.5"(876mm)
 W: 125.75"(3194mm)
 (Outside)
 113.5"(2883mm)
 (Inside)

Features

- Includes:
 (1) 57"(1448mm)H x 50"(1270mm)W screen,
 (1) 65"(1651mm)H x 50"(1270mm)W screen,
 (1) 61"(1549mm)H x 50"(1270mm)W screen.
- All screens are connected together, not interchangeable.
- Available in King, Class and Maya fabrics only; COM not available.
- Floor support and screen connectors in same color.

To Order, Specify:

- 1) Product number.
- 2) Inner material.
- 3) Outer Material.
- 4) Trim color.

Number

SON-3

Fabric Grade C

\$9820.22

D

\$11331.04

Plume 6

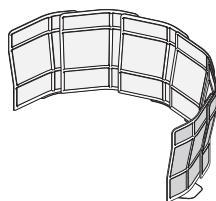

SON-6

Dimensions

H: 57"(1448mm)
 D: 84"(2134mm)
 W: 143.75"(3651mm)
 (Outside)
 132"(3353mm)
 (Inside)

Features

- Includes:
 (6) 57"(1448mm)H x 50"(1270mm)W screens.
- All screens are connected together, not interchangeable.
- Available in King, Class and Maya fabrics only; COM not available.
- Floor support and screen connectors in same color.

To Order, Specify:

- 1) Product number.
- 2) Inner material.
- 3) Outer Material.
- 4) Trim color.

SON-6

\$1885.01

\$21403.05

Plume 9

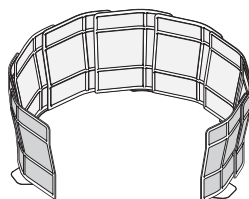

SON-9

Dimensions

H: 57"(1448mm)
 D: 128.5"(3264mm)
 W: 146.75"(3727mm)
 (Outside)
 131.25"(3334mm)
 (Inside)

Features

- Includes:
 (9) 57"(1448mm)H x 50"(1270mm)W screens.
- All screens are connected together, not interchangeable.
- Available in King, Class and Maya fabrics only; COM not available.
- Floor support and screen connectors in same color.

To Order, Specify:

- 1) Product number.
- 2) Inner material.
- 3) Outer Material.
- 4) Trim color.

SON-9

\$28327.56

\$31475.06

Note: For mixed grade fabric surfaces, pricing will be determined by the sum of the upcharges. Please refer to the electronic design and specification tools for these prices.

Note: The Openest Plume screen is made with polyester fabric adhered to a polyester core. The screen is compliant with UL-1286 flammability requirements and California Technical Bulletin TB-117-2013 requirements. The fabric covering is compliant with NFPA 701 requirements. Consult your local code authority to assure that screens are compliant prior to installation.

Note: For additional Openest products, details and specifications please refer to the Openest Price List.

Openest Collection

Feather Sofa

Feather – Symmetrical

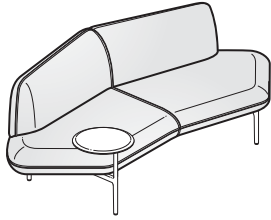

SOSS-1-RW

Dimensions

Sofa

SH: 16.5"(419mm)
 TH: 30.25"(768mm)
 SD: 25"(635mm)
 TD: 37"(940mm)
 W: 87"(2210mm)

Table

H: 19.5"(495mm)
 D: 15.75"(400mm)

Features

- Includes: Sofa with specifiable top-stitch thread and optional side mount table.
- Legs: Painted cast aluminum.
- Optional table:
 - Can be right-side or left-side mounted.
 - Rotates 360°
 - Available in Black, Polar, Stormy or Vapor painted MDF or planked wood in White Oak or Walnut.
 - Planked wood tops are designed to be unique, using solid wood planks with a clear, low-gloss finish showing natural variation.
- COM yardage: 6.5

Specification Tips

- Fabric will be applied railroaded.
- Linear or patterned fabric is not recommended due to the manner in which fabric is applied.

To Order, Specify:

1) Product number, including:

1 Surface Material:

- 1 Leather
- 2 Fabric
- 3 Faux Leather

2 Table Option:

- N No Table
- R Right Hand Table
- L Left Hand Table

- 2) Surface color.
- 3) Thread color.
- 4) Leg color.
- 5) Table finish (if applicable).

Description	Number 1 2	Fabric Grade		C	D	E	F	G	H	Leather Grade A	Leather Grade B
		A	B								
Without Table	SOSS- -N	\$3777.01	\$3991.04	\$4230.25	\$4406.51	\$4784.21	\$4973.06	\$5382.24	\$5508.15	\$7459.60	\$ 8970.41
With Painted MDF Table	SOSS- - P	4519.82	4733.85	4973.06	5149.32	5527.02	5715.87	6125.05	6250.96	8202.41	9713.22
With Wood Table - White Oak	SOSS- - W	5224.86	5438.89	5678.10	5854.36	6232.06	6420.91	6830.09	6956.00	8907.45	10418.26
With Wood Table - Walnut	SOSS- - W	5319.29	5533.32	5772.53	5948.79	6326.49	6515.34	6924.52	7050.43	9001.88	10512.69

The following options require modification of the product number.

Stain Repellent

To specify, add **-P** to the end of the product number; **Example:** SOSS-2-NP (add \$187.95 list)

For sofa without table add **OP** to the end of the product number. **Example:** SOSS-2-NOP

Feather – Asymmetrical

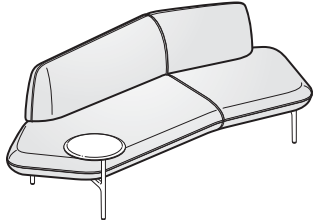

SOSR-1-RW

Dimensions

Sofa

SH: 16.5"(419mm)
 TH: 30.25"(768mm)
 SD: 25"(635mm)
 TD: 37"(940mm)
 W: 92"(2337mm)

Table

H: 19.5"(495mm)
 D: 15.75"(400mm)

Features

- Includes: Sofa with specifiable top-stitch thread and optional side mount table.
- Legs: Painted cast aluminum.
- Optional table:
 - Can be right-side or left-side mounted.
 - Rotates 360°
 - Available in Black, Polar, Stormy or Vapor painted MDF or planked wood in White Oak or Walnut.
 - Planked wood tops are designed to be unique, using solid wood planks with a clear, low-gloss finish showing natural variation.
- COM yardage: 6.75

Specification Tips

- Fabric will be applied railroaded.
- Linear or patterned fabric is not recommended due to the manner in which fabric is applied.
- Handedness determined when seated on sofa.

To Order, Specify:

1) Product number, including:

1 Handedness:

- R Right hand
- L Left hand

2 Surface Material:

- 1 Leather
- 2 Fabric
- 3 Faux Leather

3 Table Option:

- N No Table
- R Right Hand Table
- L Left Hand Table

- 2) Surface color.
- 3) Thread color.
- 4) Leg color.
- 5) Table finish (if applicable).

Description	Number 1 2 3	Fabric Grade		C	D	E	F	G	H	Leather Grade A	Leather Grade B
		A	B								
Without Table	SOS - -N	\$3839.96	\$4066.59	\$4312.09	\$4563.89	\$4941.59	\$5161.92	\$5602.57	\$5696.99	\$7516.24	\$ 9064.83
With Painted MDF Table	SOS - - P	4582.77	4809.40	5054.90	5306.70	5684.40	5904.73	6345.38	6439.80	8259.05	9807.64
With Wood Table - White Oak	SOS - - W	5287.81	5514.44	5759.94	6011.74	6389.44	6609.77	7050.42	7144.84	8964.09	10512.68
With Wood Table - Walnut	SOS - - W	5382.24	5608.87	5854.37	6106.17	6483.87	6704.20	7144.85	7239.27	9058.52	10607.11

The following options require modification of the product number.

Stain Repellent

To specify, add **P** to the end of the product number; **Example:** SOSR-2-NP (add \$187.95 list)

For sofa without table add **OP** to the end of the product number. **Example:** SOSR-2-NOP

Note: For additional Openest products, details and specifications please refer to the Openest Price List.

Openest Collection

Chick Pouf

Chick Pouf with Back

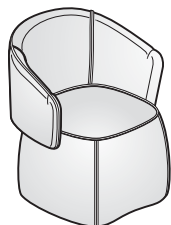

SOPB-2223

Dimensions

SH: 18"(457mm)
 TH: 37.75"(959mm)
 SD: 18.75"(476mm)
 TD: 25.2"(640mm)
 W: 26"(660mm)

Features

- Includes: Seat and back with specifiable top-stitch thread and puck colors.
- Seat back flips up and down.
- Pull tab to flip back up or down available in orange only.
- COM yardage:
 Inner/Outer surfaces matching: 3.5
 Inner Back and Seat only: 1.5
 Outer Back and Base only: 2.0

Specification Tip

- Linear or patterned fabric is not recommended due to the manner in which fabric is applied.

To Order, Specify:

1) Product number, including:

1 Inner Surface Material:

- 1 Leather
- 2 Fabric
- 3 Faux Leather

2 Outer Surface Material:

- 1 Leather
- 2 Fabric
- 3 Faux Leather

2) Inner Surface Color (Seat, inside back).

3) Outer Surface Color (Base, outer back).

4) Thread color.

5) Puck color.

Number 1 2	Fabric Grade		C	D	E	F	G	H	Leather Grade A	Leather Grade B
	A	B								
SOPB- 23-00H	\$2203.24	\$2329.14	\$2499.12	\$2656.48	\$2908.30	\$3040.50	\$3336.32	\$3430.78	\$4154.73	\$4941.61

Chick Pouf without Back

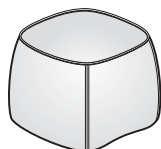

SOPN-2223

Dimensions

H: 18"(457mm)
 D: 22.5"(572mm)
 W: 23.25"(591mm)

Features

- Includes: Seat/Base only with specifiable top-stitch thread color.
- COM yardage:
 Seat and Base matching: 2.0
 Seat only: .75
 Base only: 2.0

Specification Tip

- Linear or patterned fabric is not recommended due to the manner in which fabric is applied.

To Order, Specify:

1) Product number, including:

1 Seat Surface Material:

- 1 Leather
- 2 Fabric
- 3 Faux Leather

2 Base Surface Material:

- 1 Leather
- 2 Fabric
- 3 Faux Leather

2) Inner Surface Color (Seat).

3) Outer Surface Color (Base).

4) Thread color.

Number 1 2	Fabric Grade		C	D	E	F	G	H	Leather Grade A	Leather Grade B
	A	B								
SOPN- 23-00H	\$1063.86	\$1133.08	\$1240.10	\$1353.42	\$1504.50	\$1591.36	\$1794.07	\$1844.42	\$2454.18	\$3050.96

The following options require modification of the product number.

Stain Repellent

To specify, add **-P** to the end of the product number; **Example:** SOPB-2223-P; SOPN-2223-P (add **\$94.61** list for Chick Pouf with Back or **\$54.07** for Chick Pouf without Back)

For mixed grade fabric surfaces, please refer to the electronic design and specification tools for these prices.

Openest Collection

Chick Pouf

Large Square - No Back

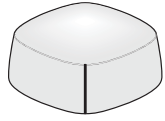

SOPN-2238

Dimensions

H: 17"(432mm)
D: 38"(965mm)
W: 38"(965mm)

Features

- Includes: Seat and base with specifiable top-stitch thread around the top and down the corners.
- Available with black hard or felt glides.
- COM yardage:
Seat and Base matching: 4.0
Seat only: 1.3
Base only: 2.6

Specification Tips

- Fabric will be applied railroaded.
- Linear or patterned fabric is not recommended due to the manner in which fabric is applied.

To Order, Specify:

1) Product number, including:

1 Seat Surface Material:

- 1 Leather
- 2 Fabric
- 3 Faux Leather

2 Base Surface Material:

- 1 Leather
- 2 Fabric
- 3 Faux Leather

3 Glide Option:

- H Hard Glides
- K Felt Glides

- 2) Seat surface color.
3) Base surface color.
4) Thread color.

Number 1 2 3	Fabric Grade		C	D	E	F	G	H	Leather Grade A	Leather Grade B
	A	B								
SOPN- 38-00	\$1525.66	\$1627.37	\$1729.07	\$1835.04	\$1932.50	\$2390.20	\$2644.47	\$3102.18	\$2923.62	\$3415.22

Rectangle - No Back

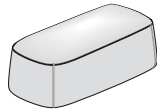

SOPN-2252

Dimensions

H: 18"(457mm)
D: 27"(686mm)
W: 52"(1321mm)

Features

- Includes: Seat and base with specifiable top-stitch thread around the top and down the corners.
- Available with black hard or felt glides.
- COM yardage:
Seat and Base matching: 4.6
Seat only: 2.0
Base only: 2.6

Specification Tips

- Fabric will be applied railroaded.
- Linear or patterned fabric is not recommended due to the manner in which fabric is applied.

To Order, Specify:

1) Product number, including:

1 Seat Surface Material:

- 1 Leather
- 2 Fabric
- 3 Faux Leather

2 Base Surface Material:

- 1 Leather
- 2 Fabric
- 3 Faux Leather

3 Glide Option:

- H Hard Glides
- K Felt Glides

- 2) Seat surface color.
3) Base surface color.
4) Thread color.

Number 1 2 3	Fabric Grade		C	D	E	F	G	H	Leather Grade A	Leather Grade B
	A	B								
SOPN- 52-00	\$1796.89	\$1915.54	\$2034.21	\$2157.83	\$2271.55	\$2804.96	\$3102.16	\$3636.16	\$3282.99	\$3798.32

The following options require modification of the product number.

Stain Repellent

To specify, add **P** to the end of the product number; **Example:** SOPN-2238-00HP
(Large Square add **\$77.98** list; Rectangle add **\$91.54** list)

For mixed grade fabric surfaces, please refer to the electronic design and specification tools for these prices.

Openest Collection

Chick Pouf

Round - No Back

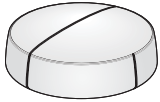

SOPN-2265

Dimensions

H: 17"(432mm)
D: 65"(1651mm)

Features

- Includes: Seat and base with specifiable top-stitch thread around the top, across the middle of the top, and four vertical seams (every 90°).
- Available with black hard or felt glides or six black braking casters.
- Braking casters lock into place when weight is loaded on the pouf.
- COM yardage:
Seat and Base matching: 8.0
Seat only: 4.0
Base only: 4.0

Specification Tips

- Fabric will be applied railroaded.
- Linear or patterned fabric is not recommended due to the manner in which fabric is applied.

To Order, Specify:

1) Product number, including:

1 Seat Surface Material:

- 2 Fabric
- 3 Faux Leather

2 Base Surface Material:

- 2 Fabric
- 3 Faux Leather

3 Glide/Caster Option:

- H Hard Glides
- K Felt Glides
- B Braking Casters (add \$417.01 list)

- 2) Seat surface color.
- 3) Base surface color.
- 4) Thread color.

Number	Fabric Grade			C	D	E	F	G	H	Leather Grade A	Leather Grade B		
	1	2	3									A	B
SOPN-■ ■ 65-00 ■				\$3322.54	\$3525.96	\$3729.40	\$3941.28	\$4136.22	\$5051.62	\$5560.18	\$6475.56	N/A	N/A

The following options require modification of the product number.

Stain Repellent

To specify, add **P** to the end of the product number; **Example:** SOPN-2265-00HP (add \$155.96 list)

For mixed grade fabric surfaces, please refer to the electronic design and specification tools for these prices.

Openest Collection

Sprig Tables

Rectangle

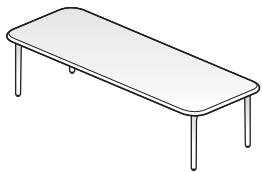

SORA-5320-P

Features

- Includes: Table top and legs.
- Top available in Black, Polar, Stormy, or Vapor painted MDF or planked wood in White Oak or Walnut.
- Planked wood tops are designed to be unique, using solid wood planks with a clear, low-gloss finish showing natural variation.
- Legs: Painted cast aluminum.

To Order, Specify:

1) Product number, including:

① Surface Material:

P Painted MDF

W Planked Wood

2) Top color.

3) Leg color.

Height	Depth	Width	Number ①	Painted	White Oak	Walnut
12"(305mm)	20"(508mm)	53"(1346mm)	SORA-5320-	\$1044.98	\$2612.44	\$3178.99

Round



SODC-1616-P



SODB-2424-P

Features

- Includes: Table top and legs.
- Top available in Black, Polar, Stormy, or Vapor painted MDF or planked wood in White Oak or Walnut.
- Planked wood tops are designed to be unique, using solid wood planks with a clear, low-gloss finish showing natural variation.
- Legs: Painted cast aluminum.

To Order, Specify:

1) Product number, including:

① Surface Material:

P Painted MDF

W Planked Wood

2) Top color.

3) Leg color.

Height	Diameter	Number ①	Painted	White Oak	Walnut
17"(432mm)	16"(406mm)	SODC-1616-	\$742.81	\$1510.81	\$1636.70
14"(356mm)	24"(610mm)	SODB-2424-	\$818.35	\$2026.99	\$2329.15

Note: For additional Openest products, details and specifications please refer to the Openest Price List.

Pip

Personal Laptop Table



STP-P26-TH

Features

- Includes table top, base and hardware.
- Top available in painted MDF or planked wood in White Oak or Walnut.
- Wood tops are designed to be unique using solid wood planks with a clear, low-gloss finish showing natural variation.
- Base: Painted aluminum support plate and column with painted steel base plate.
- Ships unassembled.

To Order, Specify:

1) Product number, including:

① Surface Material:

- P** Painted MDF
- W** Planked Wood

② Glide Type:

- H** Hard Plastic
- F** Felt

2) Top surface and color.

3) Base trim color.

Height	Depth	Width	Number		Painted MDF	White Oak	Walnut
			①	②			
26"(660mm)	13"(330mm)	21.25"(540mm)	STP- <input type="checkbox"/>	26-T <input type="checkbox"/>	\$591.56	\$1075.06	\$1208.74

This page intentionally blank

Poppy-At-A-Glance

Designer Patricia Urquiola

Fabric Linear or patterned fabric not recommended due to the manner in which the material is applied. Because of the nature of the chair, materials that have more fibers or woolen spun yarn construction, such as Cotswold, tend to upholster well on Poppy. Synthetic fibers, or textiles with heavy back coatings, tend to be more difficult to upholster and consequently may restrict some COMs.

Guest Seating

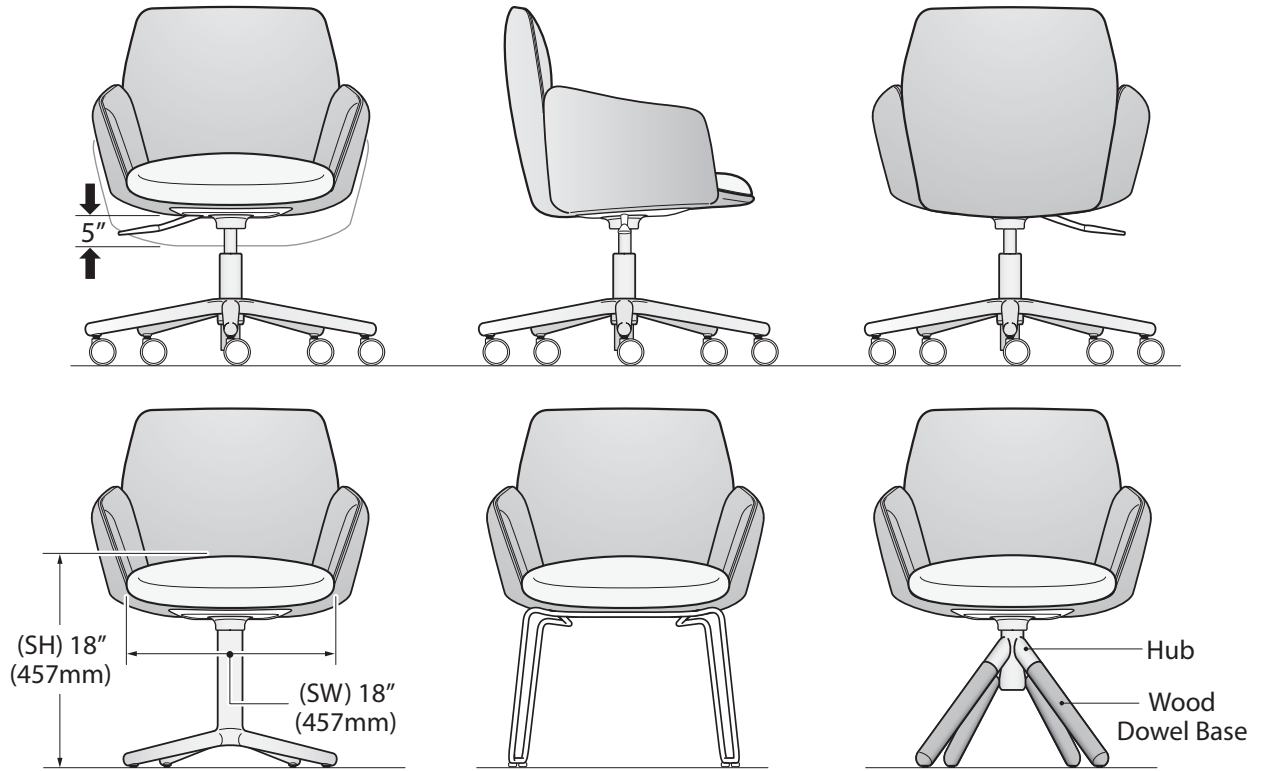

Lounge Seating

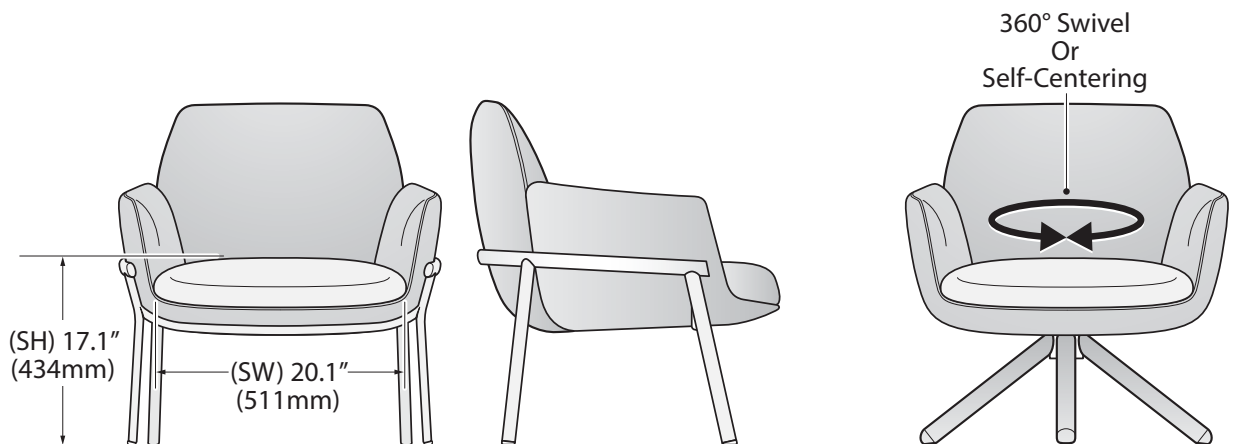

Poppy

Guest

Four Star Base with Glides



SPG-11-4

Dimensions

SH: 18"(457mm)
H: 33"(838mm)
D: 26.75"(679mm)
W: 26.75"(679mm)
SW: 18"(457mm)
SD: 18"(457mm)
AH: 25"(635mm)

Features

- Back and arms: Upholstered in matching upholstery.
- Seat: Standard upholstered. Upholstery can match or complement back and arms.
- Base: Four star aluminum base.
–Standard with glides; felt pads included
–Available in Black (TR-F) or Smooth Plaster (TR-PLS)
- Seat swivels 360°.
- COM yardage / COL square footage: 2.0/55
Back/Arms: 1.5/40
Seat: 0.5/15

Specification Tip

- Linear or patterned fabric is not recommended due to the manner in which fabric is applied.

To Order, Specify:

- 1) Product number, including;

1 Seat Upholstery:

- 1 Leather
- 2 Fabric
- 3 Faux Leather

2 Back/Arm Upholstery:

- 1 Leather
- 2 Fabric
- 3 Faux Leather

- 2) Seat surface and color.
- 3) Back/arm surface and color.
- 4) Trim color.
TR-F Black
TR-PLS Smooth Plaster, add **\$66.28** list.

Number 1 2	Fabric Grade		C	D	E	F	G	H	Leather Grade A	Leather Grade B
	A	B								
SPG- -4	\$1879.55	\$1963.89	\$2036.16	\$2138.60	\$2259.07	\$2319.31	\$2349.43	\$2409.68	\$2367.52	\$2500.03

Five Star Base with Casters



SPG-11-5

Dimensions

SH: 16"-21"
(406mm-533mm)
H: 31"-36"
(787mm-914mm)
D: 26.75"(679mm)
W: 26.75"(679mm)
SW: 18"(457mm)
SD: 18"(457mm)
AH: 23"-28"
(584mm-711mm)

Features

- Back and arms: Upholstered in matching upholstery.
- Seat: Standard upholstered. Upholstery can match or complement back and arms.
- Base: Five star aluminum base.
–Available in Black (TR-F) or Smooth Plaster (TR-PLS)
–Casters match base color; Smooth Plaster casters are two-tone with graphite tread.
- Soft casters available in black only.
- Seat swivels 360°.
- Pneumatic height adjustment of 5"(127mm).
- Tablet option:
–Tablet arm available right or left handed.
–Dual-pivot tablet rotates 360° at both the arm's pivot joint and tablet surface connection point
–Tablet surface is 11.5"(292mm)D x 19"(483mm)W and 0.75"(19mm) thick.
–Tablet surface available in painted MDF, laminate and wood in White Oak or Walnut
- COM yardage / COL square footage: 2.0/55
Back/Arms: 1.5/40
Seat: 0.5/15

Specification Tip

- Linear or patterned fabric is not recommended due to the manner in which fabric is applied.
- Handedness can be changed in the field however, tablet option cannot be added or removed in the field.
- Pivot arm/tablet will need to be field installed to the support arm.

To Order, Specify:

- 1) Product number, including;

1 Seat Upholstery:

- 1 Leather
- 2 Fabric
- 3 Faux Leather

2 Back/Arm Upholstery:

- 1 Leather
- 2 Fabric
- 3 Faux Leather

3 Tablet Option (if applicable):

- R Right Hand
- L Left Hand

- 2) Seat surface and color.
- 3) Back/arm surface and color.
- 4) Base trim color.
TR-F Black
TR-PLS Smooth Plaster, add **\$66.28** list.
- 5) Tablet surface color (if applicable).
- 6) Tablet arm trim color (if applicable).
TR-F Black
TR-PLS Smooth Plaster

Description	Number 1 2 3	Fabric Grade		C	D	E	F	G	H	Leather Grade A	Leather Grade B
		A	B								
No Tablet	SPG- -5	\$1987.99	\$2072.33	\$2144.60	\$2247.04	\$2367.51	\$2427.75	\$2457.87	\$2518.12	\$2475.96	\$2608.47
Painted MDF*	SPG- -5 P	2710.21	2801.43	2879.60	2990.40	3120.71	3185.85	3218.43	3283.59	3237.99	3381.32
Laminate - Grade A*	SPG- -5 L	2860.21	2951.43	3029.60	3140.40	3270.71	3335.85	3368.43	3433.59	3387.99	3531.32
Laminate - Grade B*	SPG- -5 L	2875.21	2966.43	3044.60	3155.40	3285.71	3350.85	3383.43	3448.59	3402.99	3546.32
Wood - White Oak*	SPG- -5 W	3670.21	3761.43	3839.60	3950.40	4080.71	4145.85	4178.43	4243.59	4197.99	4341.32
Wood - Walnut*	SPG- -5 W	3745.21	3836.43	3914.60	4025.40	4155.71	4220.85	4253.43	4318.59	4272.99	4416.32

The following options require modification of the product number.

- Soft Casters
- Stain Repellent

Change the 6th digit in the product number to **6**, and add **\$47.25** list. **Example:** SPG-22-**6**
To specify, add **P** to the end of the product number; **Example:** SPG-22-5**P** (add **\$71.09** list)

*pricing based on 2/1/22 pricing.

Poppy
Guest

Sled Base



SPG-11-7

Dimensions

SH: 18"(457mm)
H: 33"(838mm)
D: 24.25"(616mm)
W: 24.25"(616mm)
SW: 18"(457mm)
SD: 18"(457mm)
AH: 25"(635mm)

Features

- Back and arms: Upholstered in matching upholstery.
- Seat: Standard upholstered. Upholstery can match or complement back and arms.
- Base: Sled base painted in Black (TR-F) or Smooth Plaster (TR-PLS).
- Glides: Available in felt or hard plastic.
- COM yardage / COL square footage: 2.0/55
Back/Arms: 1.5/40
Seat: 0.5/15

To Order, Specify:

1) Product number, including;

1 Seat Upholstery:

- 1 Leather
- 2 Fabric
- 3 Faux Leather

2 Back/Arm Upholstery:

- 1 Leather
- 2 Fabric
- 3 Faux Leather

3 Glide Styles:

- 7 Hard
- 8 Felt

- 2) Seat surface and color.
- 3) Back/arm surface and color.
- 4) Trim color.
TR-F Black
TR-PLS Smooth Plaster, add **\$66.28** list.

Number 1 2 3	Fabric Grade			D	E	F	G	H	Leather Grade A	Leather Grade B
	A	B	C							
SPG- (M)	\$1573.95	\$1658.29	\$1730.56	\$1833.00	\$1953.47	\$2013.71	\$2043.83	\$2104.08	\$2061.92	\$2194.43

(M) Product marked with this symbol available as GSA Open Market.

Wood Base



SPG-11-W

Dimensions

SH: 18"(457mm)
H: 33"(838mm)
D: 24.25"(616mm)
W: 24.25"(616mm)
SW: 18"(457mm)
SD: 18"(457mm)
AH: 25"(635mm)

Features

- Back and arms: Upholstered in matching upholstery.
- Seat: Standard upholstered. Upholstery can match or complement back and arms.
- Base: Wooden dowel legs with painted aluminum hub.
–Wooden legs available in Clear on Oak (M5-W35), Clear on Walnut (M6-W35) and Ink on Ash (M7-W43)
–Wooden legs standard with glides; felt pads included
–Hub available in Black (TR-F) or Smooth Plaster (TR-PLS)
- Seat swivels 360°.
- COM yardage / COL square footage: 2.0/55
Back/Arms: 1.5/40
Seat: 0.5/15

To Order, Specify:

1) Product number, including;

1 Seat Upholstery:

- 1 Leather
- 2 Fabric
- 3 Faux Leather

2 Back/Arm Upholstery:

- 1 Leather
- 2 Fabric
- 3 Faux Leather

- 2) Seat surface and color.
- 3) Back/arm surface and color.
- 4) Trim color.
TR-F Black
TR-PLS Smooth Plaster, add **\$48.21** list.
- 5) Wood finish.

Specification Tip

- Linear or patterned fabric is not recommended due to the manner in which fabric is applied.

Description	Number 1 2	Fabric Grade			D	E	F	G	H	Leather Grade A	Leather Grade B
		A	B	C							
Ink on Ash	SPG- -W	\$2439.81	\$2524.15	\$2596.42	\$2698.86	\$2819.33	\$2879.57	\$2909.69	\$2969.94	\$2927.78	\$3060.29
Clear on Oak	SPG- -W	2475.95	2560.29	2632.56	2735.00	2855.47	2915.71	2945.83	3006.08	2963.92	3096.43
Clear on Walnut	SPG- -W	2488.02	2572.36	2644.63	2747.07	2867.54	2927.78	2957.90	3018.15	2975.99	3108.50

The following options require modification of the product number.

Stain Repellent

To specify, add **P** to the end of the product number; **Example:** SPG-22-WP (add **\$71.09** list)

Poppy

Lounge

Basket



SLP-22-T

Dimensions

SH: 17.1"(434mm)
 H: 32.6"(828mm)
 D: 29.4"(747mm)
 W: 31"(787mm)
 SW: 20.1"(511mm)
 SD: 20.5"(521mm)
 AH: 24"(610mm)

Features

- Back and arms: Upholstered in matching upholstery.
- Seat: Upholstery can match or complement back and arms.
- Base: Four leg painted steel basket frame.
 –Available in Black (TR-F), Smooth Plaster (TR-PLS), Sable (TR-1M) or Rusty Red (TR-RR).
- Glides: Available in felt or hard plastic.
- COM yardage / COL square footage: 4.0/72
 Back/Arms: 3.0/54
 Seat: 1.0/18

Specification Tip

- Linear or patterned fabric is not recommended due to the manner in which fabric is applied.

To Order, Specify:

- 1) Product number, including;

1 Seat Upholstery:

- 1 Leather
- 2 Fabric
- 3 Faux Leather

2 Back/Arm Upholstery:

- 1 Leather
- 2 Fabric
- 3 Faux Leather

3 Glide Style:

- F Felt
- H Hard

- 2) Seat surface and color.

- 3) Back/arm surface and color.

- 4) Trim color.

- TR-F Black
- TR-1M Sable
- TR-RR Rusty Red
- TR-PLS Smooth Plaster, add **\$64.34** list

Number 1 2 3	Fabric Grade			D	E	F	G	H	Leather Grade A	Leather Grade B
	A	B	C							
SLP- - -T -	\$2567.60	\$2713.81	\$2848.34	\$3041.33	\$3210.97	\$3860.18	\$4246.19	\$4948.04	\$5351.61	\$6527.23

Swivel



SLP-22-S
SLP-22-R

Dimensions

SH: 17.1"(434mm)
 H: 32.6"(828mm)
 D: 29.4"(747mm)
 W: 31"(787mm)
 SW: 20.1"(511mm)
 SD: 20.5"(521mm)
 AH: 24"(610mm)

Features

- Back and arms: Upholstered in matching upholstery.
- Seat: Upholstery can match or complement back and arms.
- Base: Four wooden dowel legs.
 –Legs available in Clear on Oak (M5-W35), Clear on Walnut (M6-W35) and Ink on Ash (M7-W43).
- Available with 360° or self-centering swivel base.
- Glides: Available in felt or hard plastic.
- COM yardage / COL square footage: 4.0/72
 Back/Arms: 3.0/54
 Seat: 1.0/18

Specification Tip

- Linear or patterned fabric is not recommended due to the manner in which fabric is applied.

To Order, Specify:

1 Seat Upholstery:

- 1 Leather
- 2 Fabric
- 3 Faux Leather

2 Back/Arm Upholstery:

- 1 Leather
- 2 Fabric
- 3 Faux Leather

3 Glide Style:

- F Felt
- H Hard

- 2) Seat surface and color.

- 3) Back/arm surface and color.

- 4) Wood finish

Description	Number 1 2 3	Fabric Grade			D	E	F	G	H	Leather Grade A	Leather Grade B
		A	B	C							
360° Swivel Base											
Ink on Ash	SLP- - -S -	\$3105.68	\$3251.89	\$3386.42	\$3579.41	\$3749.05	\$4398.26	\$4784.27	\$5486.12	\$5889.69	\$7065.31
Clear on Oak	SLP- - -S -	3140.78	3286.99	3421.52	3614.51	3784.15	4433.36	4819.37	5521.22	5924.79	7100.41
Clear on Walnut	SLP- - -S -	3199.27	3345.48	3480.01	3673.00	3842.64	4491.85	4877.86	5579.71	5983.28	7158.90
Self-Centering Base											
Ink on Ash	SLP- - -R -	\$3134.92	\$3281.13	\$3415.66	\$3608.65	\$3778.29	\$4427.50	\$4813.51	\$5515.36	\$5918.93	\$7094.55
Clear on Oak	SLP- - -R -	3170.02	3316.23	3450.76	3643.75	3813.39	4462.60	4848.61	5550.46	5954.03	7129.65
Clear on Walnut	SLP- - -R -	3228.51	3374.72	3509.25	3702.24	3871.88	4521.09	4907.10	5608.95	6012.52	7188.14

The following options require modification of the product number.

Stain repellent

To specify, add **P** to end of the product number (add **\$107.61** list); **Example:** SLP-22-TFP

NOTE: For mixed grade fabrics on seat and back please refer to the electronic design and specification tools for pricing.

Harbor Work Lounge At-A-Glance

Designer

Nicolai Czumaj-Bront of the Haworth Design Studio

Awards/Achievements

Best of Neocon 2013: Silver - Seating/Collaborative Work
 Good Design Award 2013 - Furniture

Inner Shell
 (Upholstered Only)

Outer Shell
 (Upholstered,
 Laminate, Wood Veneer)

Caster Options:

Hard or Soft (Black)



Hard (Fog & Gray)



Glide



Fully Upholstered

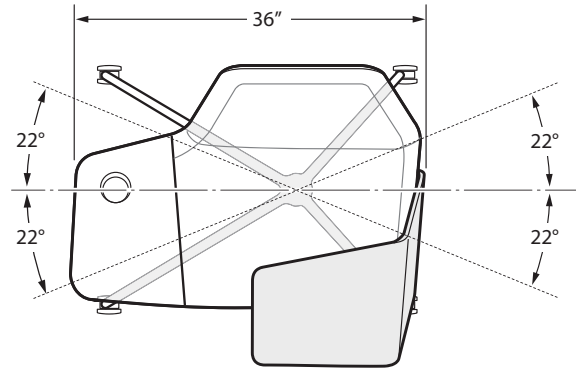
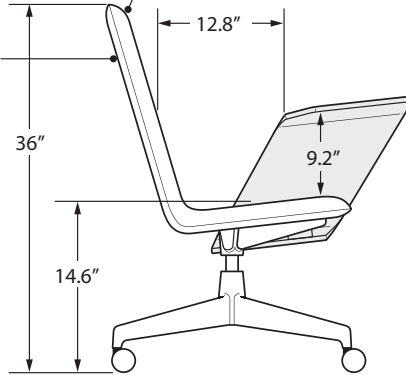

Cup Holder Fully Upholstered

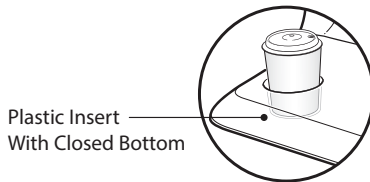

Cup Holder Partially Upholstered

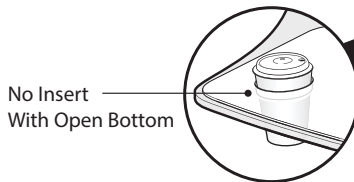

Partially Upholstered

Wing:
 Available as Left
 or Right handed.
 Noble Fabric Only

Tablet:
 Laminate or Wood

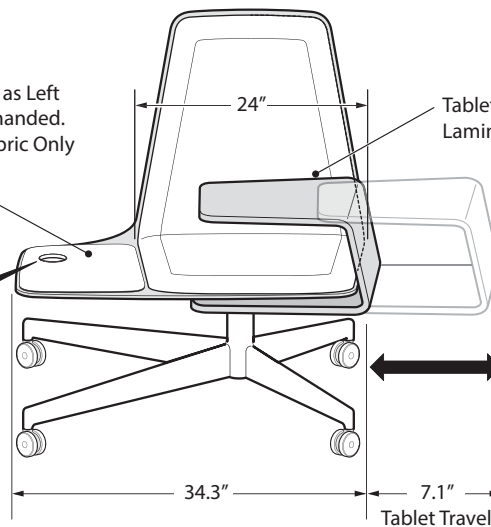

Harbor Work Lounge

Fully Upholstered, Cast Aluminum Base

Lounge Chair



SHL-22-1R10



SHL-22-1R12

Dimensions

SH: 14.6" (371mm)
 H: 36" (9147mm)
 W: 35.3" (897mm) w/o tablet
 36" (914mm) w/tablet
 SD: 16" (406mm)
 SW: 24" (610mm)

Features

- Includes: Upholstered outer and inner shell, right or left wing with cup holder, optional tablet arm and cast aluminum base.
- Fully upholstered lounge chair will be completely upholstered (No laminate or wood veneer visible). Upholstery must be the same material type for inner and outer shell.
- Outer Shell: Upholstered one-piece molded plywood shell.
- Inner Shell: Upholstered molded foam 1.25"(31.75mm) thick.
- Base: Cast-aluminum.
 - Standard painted in Black, Accent Orange, Smooth Plaster or with optional polished aluminum.
 - Swivels 22° in each direction and features a self-returning mechanism.
- Casters: Available with hard black, soft black or hard two-tone.
- Glides: Optional glides ship with plastic and felt tips.
- Seat Wing: Upholstered in Noble performance suede only. Handedness determined by seated position.
- Cup Holder: Available in Chalk or Black plastic.
- Tablet Arm: Optional tablet arm is a one-piece molded plywood form, available in laminate or wood veneer.
 - Laminate finishes include Linen, Putty or Charcoal.
 - Wood veneer finishes include Rift-Cut White Oak or Walnut.
 - Tablet slides 7.1"(180.3mm) to the side.
 - Available in right or left-hand configuration (opposite of seat wing specification).
- COM Yardage / COL square footage
 Inner/Outer Shell: 2.0/28

To Order, Specify:

1) Product number, including:

1 Base Option:

- 1** Hard Caster
- 2** Soft Caster, add **\$49.50** list
- T** Two-Tone
- G** Glides, add **\$192.17** list

2 Wing Option:

- R** Right Wing
- L** Left Wing

3 Tablet Option:

- 0** No Tablet
- 1** Wood Tablet, add **\$1828.96** list
- 2** Laminate Tablet, add **\$1828.96** list

2) Inner shell material.

3) Outer shell material.

4) Base color
 Polished aluminum, add **\$99.40** list.

5) Wing surface and color.

6) Cup holder color.

7) Tablet surface and color.

	Number	Fabric Grade										Leather Grade A	Leather Grade B	
		1	2	3	A	B	C	D	E	F	G			H
Leather	SHL-11-	■	■	1 ■	N/A	N/A	N/A	N/A	N/A	N/A	N/A	N/A	\$4121.78	\$4472.99
Fabric	SHL-22-	■	■	1 ■	\$2697.05	\$2787.16	\$2881.29	\$2978.01	\$3122.49	\$3273.57	\$3431.29	\$3598.28	N/A	N/A
Faux Leather	SHL-33-	■	■	1 ■	\$2697.05	\$2787.16	\$2881.29	\$2978.01	\$3122.49	\$3273.57	\$3431.29	\$3598.28	N/A	N/A

Harbor Work Lounge

Fully Upholstered, Cast Aluminum Base

Ottoman



SHO-22-G

Dimensions

H: 16.5"-19.5"
(419mm-495mm)
D: 17.9" (455mm)
W: 24.9" (632mm)

Features

- Includes: Fully upholstered surface, cup holder and cast aluminum base.
- Fully upholstered ottoman will be completely upholstered (no laminate or wood veneer visible).
- Surface: Upholstered one-piece molded plywood.
- Cushion: Upholstered molded foam 1.25"(31.75mm) thick.
- Cast Aluminum Base: Features 3.0"(76.2mm) height adjustment.
-Standard painted in Black, Accent Orange, Smooth Plaster or with optional polished aluminum.
- Cup holder: Swing out open hole cup holder standard in polished aluminum.
- Casters: Available with hard black, soft black or hard two-tone.
- Glides: Optional glides ship with plastic and felt tips.
- COM Yardage / COL square footage: 1.0/12

To Order, Specify:

- 1) Product number, including:
 - 1** Base Option:
 - 1** Hard Caster
 - 2** Soft Caster, add **\$49.50** list
 - T** Two-Tone
 - G** Glides, add **\$192.17** list
- 2) Surface material.
- 3) Base color
Polished aluminum, add **\$99.40** list.

	Number 1	Fabric Grade		C	D	E	F	G	H	Leather Grade A	Leather Grade B
		A	B								
Leather	SHO-11-	N/A	N/A	N/A	N/A	N/A	N/A	N/A	N/A	\$2732.82	\$2960.77
Fabric	SHO-22-	\$1802.44	\$1862.07	\$1923.04	\$1986.68	\$2080.76	\$2178.83	\$2282.21	\$2390.87	N/A	N/A
Faux Leather	SHO-33-	\$1802.44	\$1862.07	\$1923.04	\$1986.68	\$2080.76	\$2178.83	\$2282.21	\$2390.87	N/A	N/A

Harbor Work Lounge

Partially Upholstered, Cast Aluminum Base

Lounge Chair



SHL-25-1L10



SHL-25-1L12

Dimensions

SH: 14.4" (366mm)
 H: 35.5" (902mm)
 W: 34.3" (8714mm) w/o tablet
 35.5" (902mm) w/tablet
 SD: 16" (406mm)
 SW: 24" (610mm)

Features

- Includes: Laminate or wood veneer outer shell, fabric inner shell, right or left wing with cup holder, optional tablet arm and cast aluminum base.
- Outer Shell: One-piece molded plywood shell with exposed laminate or wood veneer.
- Inner Shell: Upholstered molded foam 1" (25.4 mm) thick with exposed laminate or wood veneer perimeter.
- Base: Cast-aluminum.
 - Standard painted in Black, Accent Orange, Smooth Plaster or with optional polished aluminum.
 - Swivels 22° in each direction and features a self-returning mechanism.
- Casters: Available with hard black, soft black or hard two-tone.
- Glides: Optional glides ship with plastic and felt tips.
- Seat Wing: Upholstered in Noble performance suede only. Handedness determined by seated position.
- Cup Holder: Open hole - no finish options.
- Tablet Arm: Optional tablet arm is a one-piece molded plywood form, available in laminate or wood veneer.
 - Laminate finishes include Linen, Putty or Charcoal.
 - Wood veneer finishes include Rift-Cut White Oak or Walnut.
 - Tablet slides 7.1" (180.3mm) to the side.
 - Available in right or left-hand configuration (opposite of seat wing specification).
- COM Yardage / COL square footage
 Inner Shell: 1.25/22

To Order, Specify:

1) Product number, including:

1 Base Option:

- 1** Hard Caster
- 2** Soft Caster, add **\$49.50** list
- T** Two-Tone
- G** Glides, add **\$192.17** list

2 Wing Option:

- R** Right Wing
- L** Left Wing

3 Tablet Option:

- 0** No Tablet
- 1** Wood Tablet, add **\$1828.96** list
- 2** Laminate Tablet, add **\$1828.96** list

- 2) Inner shell material.
- 3) Outer shell material.
- 4) Base color
Polished aluminum, add **\$99.40** list.
- 5) Wing surface and color.
- 6) Tablet surface and color.

	Number	Laminate Grade A Fabric Grade								Leather Grade A	Leather Grade B			
		1	2	3	A	B	C	D	E			F	G	H
Leather	SHL-15-			1	N/A	N/A	N/A	N/A	N/A	N/A	N/A	N/A	\$4979.26	\$5330.47
Fabric	SHL-25-			1	\$3554.53	\$3644.64	\$3738.77	\$3835.49	\$3979.97	\$4131.05	\$4288.77	\$4455.76	N/A	N/A
Faux Leather	SHL-35-			1	\$3554.53	\$3644.64	\$3738.77	\$3835.49	\$3979.97	\$4131.05	\$4288.77	\$4455.76	N/A	N/A

	Number	Wood Fabric Grade								Leather Grade A	Leather Grade B			
		1	2	3	A	B	C	D	E			F	G	H
Leather	SHL-14-			1	N/A	N/A	N/A	N/A	N/A	N/A	N/A	N/A	\$5034.93	\$5386.14
Fabric	SHL-24-			1	\$3610.20	\$3700.31	\$3794.44	\$3891.16	\$4035.64	\$4186.72	\$4344.44	\$4511.43	N/A	N/A
Faux Leather	SHL-34-			1	\$3610.20	\$3700.31	\$3794.44	\$3891.16	\$4035.64	\$4186.72	\$4344.44	\$4511.43	N/A	N/A

Harbor Work Lounge

Partially Upholstered, Cast Aluminum Base

Ottoman



SHO-25-G

Dimensions

H: 16.25"-19.25"
(413mm-489mm)
D: 17.9" (455mm)
W: 24.9" (632mm)

Features

- Includes: Laminate or wood veneer surface, fabric cushion, cup holder and cast aluminum base.
- Upholstered one-piece molded plywood.
- Cushion: Upholstered molded foam 1"(25.4mm) thick with exposed laminate or wood veneer perimeter.
- Cast Aluminum Base: Features 3.0"(76.2mm) height adjustment.
-Standard painted in Black, Accent Orange, Smooth Plaster or with optional polished aluminum.
- Cup holder: Swing out open hole cup holder standard in polished aluminum.
- Casters: Available with hard black, soft black or hard two-tone.
- Glides: Optional glides ship with plastic and felt tips.
- COM Yardage / COL square footage: 1.0/10

To Order, Specify:

- 1) Product number, including:
 - 1** Base Option:
 - 1** Hard Caster
 - 2** Soft Caster, add **\$49.50** list
 - T** Two-Tone
 - G** Glides, add **\$192.17** list
- 2) Inner surface material.
- 3) Outer surface material.
- 4) Base color
Polished aluminum, add **\$99.40** list.

	Number ①	Laminate Grade A Fabric Grade								Leather Grade A	Leather Grade B
		A	B	C	D	E	F	G	H		
Leather	SHO-15-	N/A	N/A	N/A	N/A	N/A	N/A	N/A	N/A	\$2946.20	\$3174.15
Fabric	SHO-25-	\$2015.82	\$2075.45	\$2136.42	\$2200.06	\$2294.14	\$2392.21	\$2495.59	\$2604.25	N/A	N/A
Faux Leather	SHO-35-	\$2015.82	\$2075.45	\$2136.42	\$2200.06	\$2294.14	\$2392.21	\$2495.59	\$2604.25	N/A	N/A

	Number ①	Wood Fabric Grade								Leather Grade A	Leather Grade B
		A	B	C	D	E	F	G	H		
Leather	SHO-14-	N/A	N/A	N/A	N/A	N/A	N/A	N/A	N/A	\$2978.00	\$3205.95
Fabric	SHO-24-	\$2047.62	\$2107.25	\$2168.22	\$2231.86	\$2325.94	\$2424.01	\$2527.39	\$2636.05	N/A	N/A
Faux Leather	SHO-34-	\$2047.62	\$2107.25	\$2168.22	\$2231.86	\$2325.94	\$2424.01	\$2527.39	\$2636.05	N/A	N/A

Hello Seating

Lounge with Legs

Standard Arm

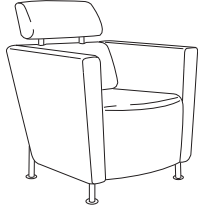

4854-0011

Dimensions

SH: 17.5"(445mm)
H: 35"(889mm)
D: 30.25"(768mm)
W: 30.5"(775mm)
SD: 20.25"(514mm)
SW: 21.25"(540mm)
AH: 9.5"(241mm)

Features

- Available as single cushion lounge chair.
- Upholstered back/seat.
- Passive lumbar back support.
- Interior frame has glued and doweled joints, reinforced with screws and cleats.
- Exposed metal legs.
- Optional two fabrics/one fabric two colors available on seat and back.
- Optional accessories include cup holder and tablet arm.
- Legs, back support uprights and optional grommets are available in TR-LE Metallic Silver only.
- COM yardage / COL square footage:
One Seat Lounge: 4.25/76.5
Seat: 1.0/18.0
Back and Arms: 3.25/58.7

To Order, Specify:

- 1) Product number.
- 2) Fabric surface and color.
or 2a. Fabric surface and color for seat.
2b. Fabric surface and color for back and arms
- 3) Trim color for legs, back support uprights (grommets)
(Available in TR-LE Metallic Silver Only)

Description	Number	Fabric Grade								Leather Grade A	Leather Grade B
		A	B	C	D	E	F	G	H		
Lounge chair w/o grommets	4854-0011	\$2396.20	\$2600.90	\$2775.49	\$3163.84	\$3275.21	\$3436.24	\$3659.03	\$4274.63	\$ 6402.91	\$ 8611.74
Lounge chair with grommets	4854-0011-G	2509.10	2713.00	2888.39	3276.74	3388.11	3549.14	3771.93	4387.53	6515.01	8724.64
Lounge chair with two fabrics/colors	4854-0011-T	2396.20	2805.60	3154.78	3931.48	4154.22	4476.28	4921.86	6153.06	10409.62	14827.28
Lounge chair with grommets/ two fabrics/two colors of same fabric	4854-0011-GT	2509.10	2918.50	3267.68	4044.38	4267.12	4589.18	5034.76	6265.96	10522.52	14940.18

The following options require modification of the product number.

Stain Repellent

To specify, add **-P** to the end of the product number; **Example:** 4854-0011-**P** (add **\$78.25** list)

Moisture Barrier with Stain Repellent

To specify, add **-D** to the end of the product number; **Example:** 4854-0011-**D** (add **\$123.41** list)

Leather Upholstery

To specify, change the 2nd digit in the product number from an **8** to a **7** and specify the leather surface and color;
Example: 4754-0011

NOTE: Stain repellent and moisture barrier are not available on leather or faux leather.

For available fabrics, refer to surfaces.haworth.com.

Hello Seating

Mobile Lounge

Standard Arm

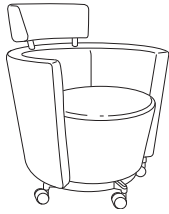

4855-0043



4855-0043-GX

Dimensions

SH: 17.25"(438mm)
H: 34.75"(883mm)
D: 26"(660mm)
W: 30.75"(781mm)
SD: 19.5"(495mm)
SW: 18.75"(476mm)
AH: 9.5"(241mm)

Features

- Upholstered back/seat.
- 360° swivel base standard.
- Passive lumbar back support.
- Casters: Standard with two-tone hard casters.
- Optional two-tone soft casters.
- Optional two fabrics/two colors of same fabric available on seat and back.
- Optional grommets to accommodate cup holder or tablet arm.
- Optional fully-loaded mobile lounge includes accessories as listed below.
- Optional accessories include cup holder and tablet arm.
- Swivel base, back support uprights and optional grommets are available in TR-LE Metallic Silver only.
- COM yardage / COL square footage:
Lounge: 4.0/72.0
Seat: 1.14/18.0
Back and Arms: 3.75/67.5

To Order, Specify:

- 1) Product number.
- 2) Fabric surface and color.
or 2a. Fabric surface and color for seat.
2b. Fabric surface and color for back and arms.
- 3) Trim color of base (grommets, cup holder).
(Available in TR-LE Metallic Silver Only)
- 4) Wood finish color (tablet arm/cup holder)

Description	Number	Fabric Grade								Leather Grade A	Leather Grade B
		A	B	C	D	E	F	G	H		
Upholstered/One Fabric and Color											
Upholstered	4855-0043	\$2361.57	\$2522.61	\$2662.61	\$2687.71	\$2713.78	\$3339.91	\$3549.13	\$4130.12	\$3371.52	\$3926.91
Upholstered/grommet	4855-0043-G	2474.47	2635.51	2775.51	2800.61	2826.68	3452.81	3662.03	4243.02	3484.42	4039.81
Upholstered/Two Fabrics or One Fabric, Two Colors											
Upholstered	4855-0043-T	\$2361.57	\$2683.65	\$2963.65	\$3014.81	\$3065.99	\$4318.25	\$4736.69	\$5898.67	\$4381.47	\$5492.25
Upholstered/grommet	4855-0043-GT	2474.47	2796.55	3076.55	3127.71	3178.89	4431.15	4849.59	6011.57	4494.37	5605.15
Fully-Loaded Mobile Lounge											
Includes grommet, tablet arm, cup holder	4855-0043-GX	\$2912.46	\$3007.50	\$3213.50	\$3239.08	\$3264.67	\$3890.80	\$4100.02	\$4681.01	\$3922.41	\$4477.80
Includes grommet, tablet arm, cup holder in two fabrics/two colors	4855-0043-GTX	2912.46	3277.54	3514.54	3565.70	3616.88	4869.14	5287.58	6449.56	4932.36	6043.14

The following options require modification of the product number.

- Soft Caster To specify, add **-2** to product number; **Example:** 4855-0043-2G (add \$49.50 list)
- Stain Repellent To specify, add **P** to product number; **Example:** 4855-0043-GP (add \$78.25 list)
- Moisture Barrier with Stain Repellent To specify, add **D** to the end of the product number; **Example:** 4855-0043-GD (add \$123.41 list)
- Leather Upholstery To specify, change the 2nd digit in the product number from an **8** to a **7** and specify the leather surface and color; **Example:** 4755-0043

NOTE: Stain repellent and moisture barrier are not available on leather or faux leather.

For available fabrics, refer to surfaces.haworth.com.

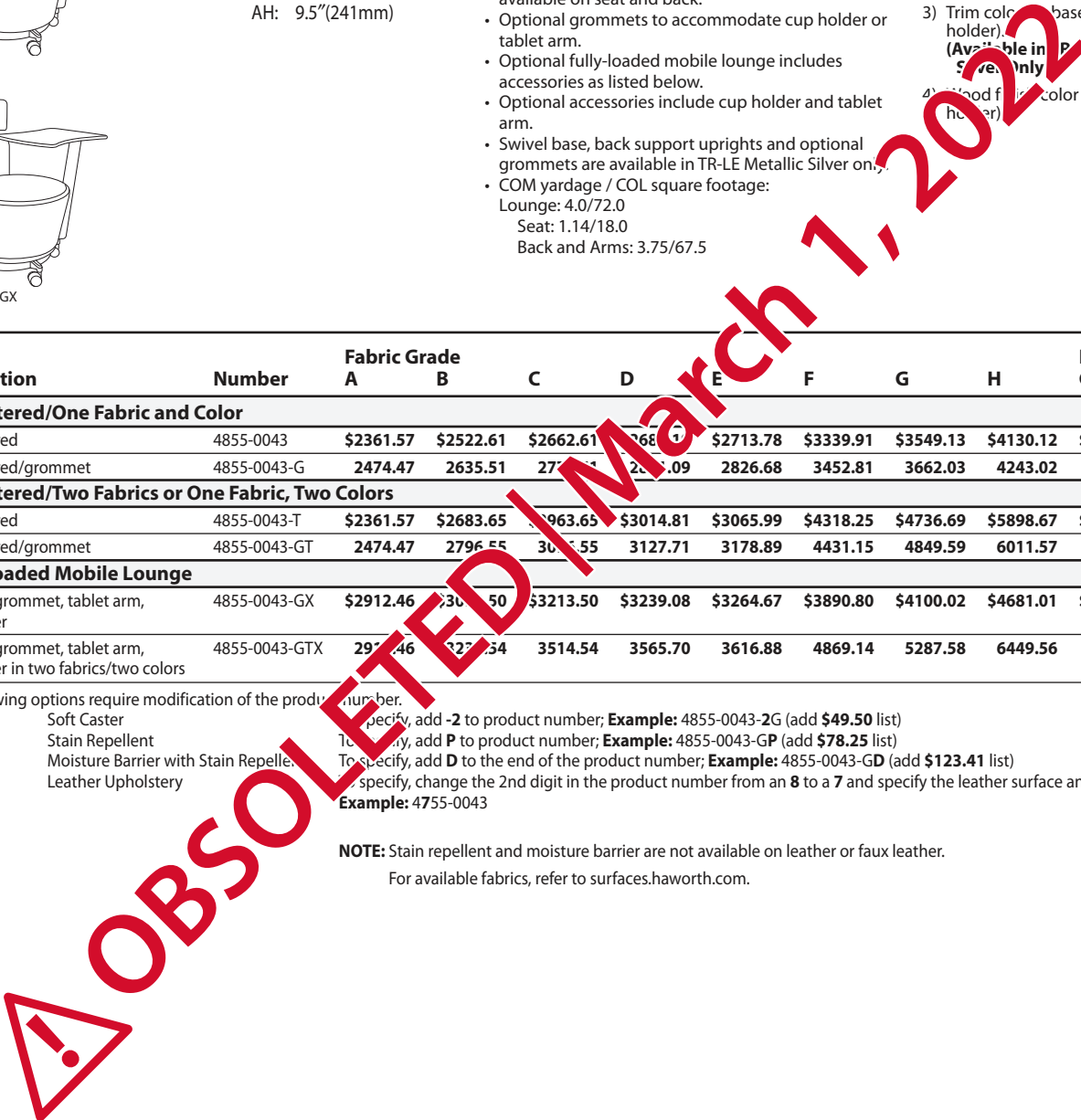

Hello Seating

Accessories



4858-0001
(Tablet Arm)



4858-0002
(Cup Holder)

Dimensions

Tablet Arm:
W: 12.68"(322.1mm)
L: 15"(381mm)

Cup Holder:
W: 5.47"(138.94mm)
L: 7.47"(189.61mm)

Features

- Plywood construction.
- Accessories are non-handed.
- Tablet arm and cup holder supports are available in TR-LE Metallic Silver only.

To Order, Specify:

- 1) Product number.
- 2) Wood finish color.
- 3) Trim color for metal trim (Available in TR-LE Metallic Silver Only)

Description

Number

Price

Fold Away Tablet Arm	4858-0001	\$307.05
Cup Holder	4858-0002	174.59

Mini-mobile

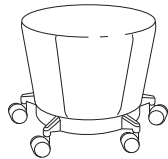

4856-0043

Dimensions

SH: 17.5"(445mm)
SD: 19.5"(495mm)

Features

- Available as single upholstery seat.
- Casters: Standard with one-tone hard casters.
- Optional two-tone soft casters.
- COM yardage / COL square footage: 1.0/18.0

To Order, Specify:

- 1) Product number.
- 2) Fabric surface and color.
- 3) Trim color for base (Available in TR-LE Metallic Silver Only)

Description	Number	Fabric Grade		D	E	F	G	H	Leather Grade A	Leather Grade B	
		A	B								
Armless	4856-0043	\$1049.09	\$1111.17	\$1320.13	\$1375.71	\$1401.30	\$1416.35	\$1496.10	\$1712.85	\$2059.04	\$2614.43

The following options require modification of the product number:

- Soft Caster To specify, add **-2** to product number; **Example:** 4856-0043-2 (add \$49.50 list)
- Stain Repellent To specify, add **-P** to product number; **Example:** 4856-0043-P (add \$46.66 list)
- Moisture Barrier with Stain Repellent To specify, add **-D** to the end of the product number; **Example:** 4856-0043-D (add \$61.70 list)
- Leather Upholstery To specify, change the 2nd digit in the product number from an **8** to a **7** and specify the leather surface and color; **Example:** 4756-0043

NOTE: Stain repellent and moisture barrier are not available on leather or faux leather.
For available fabrics, refer to surfaces.haworth.com.

Hello Seating

Guest Seating

Fixed Arm, Wood Legs



4851-0011-W



4851-0012-W

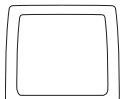

4851-0013-W

Dimensions

- SH: 18.25"(464mm)
- H: 33"(838mm)
- D: 20.5"(521mm)
- W: 22"(559mm)
- SD: 17.25"(438mm)
- SW: 18"(457mm)
- AH: 8"(203mm)

Features

- Wood or upholstered back.
- Wood legs.
- Upholstered seat.
- Non-stacking.
- Maple frame construction.
- Metal back arm attachment.
- Open arms.
- Back Options include wood slat, wood perforated or upholstered.
- COM yardage / COL square footage: Upholstered seat or upholstered seat/back: 0.75/13.5

To Order Chair with Wood Back, Specify:

- 1) Product number.
- 2) Fabric surface and color (front).
- 3) Wood finish color (back and legs).
- 4) Trim color for back attachment. **(Available in TR-LE Metallic Silver Only)**

To Order Chair with Upholstered Back, Specify:

- 1) Product number.
- 2) Fabric surface and color.
- 3) Wood finish color (back and legs).
- 4) Trim color for back attachment. **(Available in TR-LE Metallic Silver Only)**

Description	Number	Fabric Grade								Leather Grade A	Leather Grade B
		A	B	C	D	E	F	G	H		
Wood Perforated Back	4851-0011-W	\$1530.73	\$1559.37	\$1571.30	\$1601.46	\$1622.54	\$1837.78	\$1902.50	\$2084.64	\$1943.14	\$2171.50
Wood Slat Back	4851-0012-W	1530.73	1559.37	1571.36	1601.46	1622.54	1837.78	1902.50	2084.64	1943.14	2171.50
Upholstered Back	4851-0013-W	1904.02	1932.12	1944.65	1974.75	1995.83	2211.07	2275.79	2457.93	2316.43	2544.79

The following options require modification of the product number:
 Stain Repellent: To specify, add **P** to product number; **Example:** 4851-0011-WP (add \$46.66 list)
 Moisture Barrier with Stain Repellent: To specify, add **D** to the end of the product number; **Example:** 4851-0011-WD (add \$61.70 list)
 Leather Upholstery: To specify, change the 2nd digit in the product number from an **8** to a **7** and specify the leather surface and color; **Example:** 4751-0011-W

NOTE: Stain repellent and moisture barrier are not available on leather or faux leather.
 For available fabrics, refer to surfaces.haworth.com.



OBSOLETE / September 2022

ToDo

General Specifications

Features and Options**Frame**

- Combination of hardwood rails, premium grade plywood and engineering grade oriented strand board
- The seat, back and arms use a box construction method. Each box is then fastened together using metal T-nuts.
- Optional back handle

Cushioning

- High-density foam
- Webbed seat and back

Upholstery

- One Fabric
- Two Fabrics (first fabric on seat, back and ottoman; second fabric on arm structures)
- Faux Leather
- Leather

Base Options

- Stationary
 - 2 metal legs front and rear
- Mobile
 - 2 twin-wheel casters front, 2 metal legs rear

Accessory Options

- Tablet
- Cup holder
- Grommet cover

Grommet Options

- None (no cut-outs in arms)
- Right Arm (as seated)
- Left Arm (as seated)
- Both Arms

COM & COL General Information

To order a COM fabric (Customer's Own Material), contact the Haworth Inquiry Center (1.800.426.8562), your local Haworth dealer, or go to haworth.com/surfaces > COM Library to find out if the COM you have selected has already been tested and approved. The surface collection site also has information on the Haworth + alliance program with Carnegie, Luna Textiles, and Maharam as well as our industry-leading Pre-Approved COM program.

COM fabrics are placed into Grades based on the cost per linear yard. If a fabric's cost exceeds the range of our highest Grade it will be noted as Non-Graded. The product will be priced at Grade A; the COM fabric costs will appear as a separate line item. The fabric charge will be Haworth's purchase cost plus a 4% administrative fee (based on the cost of the fabric). Yardage calculations will include any applicable fabric repeat.

COM Leather products will be priced at a leather Grade A; COL costs will appear as a separate line item. The leather costs will be Haworth's purchase cost plus a 4% administrative fee (based on the cost of the leather).

Specification Guidelines

- When more than two fabrics are specified on a ToDo chair contact Haworth Specials for pricing and lead time.
- Mixing of materials such as vinyl and fabric on chair contact specials for pricing.
- **A grommet option (suffix -R, -L or -B) must be included in the ToDo chair specification in order to accept tablet arms or cup holders.**
- Tablet arms and cup holders must be ordered separately.

To insure order accuracy and acceptance, features and options must be specified in the following order (top-down):

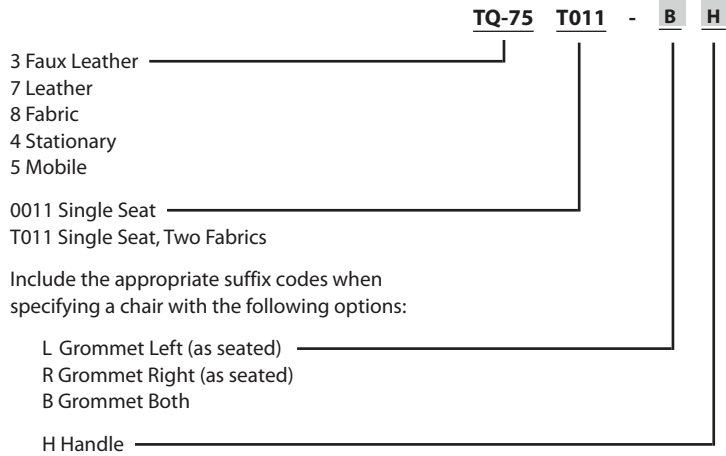

- ToDo Leather, Mobile, Single Seat with two fabrics, Grommet Both, Handle

ToDo

Single, Stationary

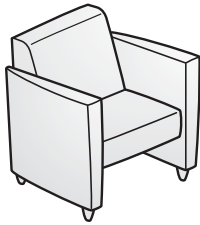

TQ84-0011

Dimensions

Overall:
 H 31.25"(794mm)
 D 29.25"(743mm)
 W 30"(762mm)
 Seat:
 H 17.5"(445mm)
 D 19"(483mm)
 W 21.5"(546mm)
 Arm:
 H 24.125"(613mm)

Features

- COM yardage / COL square footage:
 ToDo Single: 5.0/96.0
 Seat and Back: 4.0/72.0
 Arms Only: 3.0/54.0

Specification Tips

- For help in specifying multiple options, refer to page 249.
- When specifying mixed grade fabrics, list price will not exceed the highest grade fabric specified.

To Order, Specify:

- 1) Product number.
- 2) Fabric or
 - a. Fabric for seat and back.
 - b. Fabric for arms.
- 3) Trim color for feet, grommets and handle.

Description	Number	Fabric Grade								Leather Grade A	Leather Grade B
		A	B	C	D	E	F	G	H		
One Fabric											
Standard	TQ84-0011	\$2987.70	\$3084.00	\$3240.60	\$3345.94	\$3713.20	\$4209.86	\$4468.74	\$5194.26	\$4667.44	\$5596.64
With Grommet Right	TQ84-0011-R	3032.84	3129.14	3285.74	3391.08	3758.34	4255.00	4513.88	5239.40	4712.58	5641.78
With Grommet Left	TQ84-0011-L	3032.84	3129.14	3285.74	3391.08	3758.34	4255.00	4513.88	5239.40	4712.58	5641.78
With Grommet Both	TQ84-0011-B	3077.98	3174.28	3330.88	3436.22	3803.48	4300.14	4559.02	5284.54	4757.72	5686.92
With Handle	TQ84-0011-H	3082.53	3178.83	3335.43	3440.77	3808.03	4304.69	4563.57	5289.09	4762.27	5691.47
Two Fabrics											
Standard	TQ84-T011	\$3090.06	\$3186.36	\$3342.96	\$3448.30	\$3815.56	\$4312.22	\$4571.10	\$5296.62	\$4769.80	\$5699.00
With Grommet Right	TQ84-T011-R	3135.20	3231.50	3388.10	3493.44	3860.70	4357.36	4616.24	5341.76	4814.94	5744.14
With Grommet Left	TQ84-T011-L	3135.20	3231.50	3388.10	3493.44	3860.70	4357.36	4616.24	5341.76	4814.94	5744.14
With Grommet Both	TQ84-T011-B	3180.34	3276.64	3433.24	3538.58	3905.84	4402.50	4661.38	5386.90	4860.88	5789.28
With Handle	TQ84-T011-H	3184.89	3281.19	3437.79	3543.13	3910.39	4407.05	4665.93	5391.45	4864.63	5793.83

The following options require modification of the product number.

- | | |
|---------------------------------------|---|
| Faux Leather | To specify, change the 3rd digit from an 8 to a 3; Example: TQ34-0011 |
| Leather | To specify, change the 3rd digit from an 8 to a 7; Example: TQ74-0011 |
| Stain repellent | To specify, add -P to the end of the product number; Example: TQ84-0011- P (add \$78.25 list) |
| Moisture Barrier with Stain Repellent | To specify, add -D to the end of the product number; Example: TQ84-0011- D (add \$123.41 list) |
- For available fabrics, refer to surfaces.haworth.com.

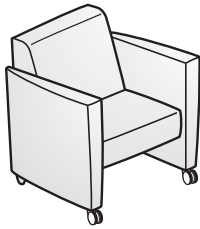

TQ85-0011

Dimensions

Overall:
 H 31.25"(794mm)
 D 29.25"(743mm)
 W 30"(762mm)
 Seat:
 H 17.5"(445mm)
 D 19"(483mm)
 W 21.5"(546mm)
 Arm:
 H 24.25"(613mm)

Features

- COM yardage / COL square footage:
 ToDo Single: 5.0/96.0
 Seat and Back: 4.0/72.0
 Arms Only: 3.0/54.0

Specification Tips

- For help in specifying multiple options, refer to page 249.
- When specifying mixed grade fabrics, list price will not exceed the highest grade fabric specified.

To Order, Specify:

- 1) Product number.
- 2) Fabric or
 a. Fabric for seat and back.
 b. Fabric for arms.
- 3) Trim color for feet, grommets and handle.

Description	Number	Fabric Grade								Leather Grade A	Leather Grade B
		A	B	C	D	E	F	G	H		
One Fabric											
Standard	TQ85-0011	\$2987.70	\$3084.00	\$3245.08	\$3351.96	\$3713.20	\$4209.86	\$4474.80	\$5198.78	\$4668.98	\$5593.78
With Grommet Right	TQ85-0011-R	3032.84	3129.14	3290.22	3397.10	3758.34	4255.00	4519.94	5243.92	4714.12	5638.92
With Grommet Left	TQ85-0011-L	3032.84	3129.14	3290.22	3397.10	3758.34	4255.00	4519.94	5243.92	4714.12	5638.92
With Grommet Both	TQ85-0011-B	3078.02	3174.32	3335.40	3442.28	3803.52	4300.18	4565.12	5289.10	4759.30	5684.10
With Handle	TQ85-0011-H	3082.53	3178.83	3339.91	3446.79	3808.03	4304.69	4569.63	5293.61	4763.81	5688.61
Two Fabrics											
Standard	TQ85-T011	\$3090.06	\$3186.36	\$3347.44	\$3454.32	\$3815.56	\$4312.22	\$4577.16	\$5301.14	\$4771.34	\$5696.14
With Grommet Right	TQ85-T011-R	3135.20	3231.50	3392.58	3499.46	3860.70	4357.36	4622.30	5346.28	4816.48	5741.28
With Grommet Left	TQ85-T011-L	3135.20	3231.50	3392.58	3499.46	3860.70	4357.36	4622.30	5346.28	4816.48	5741.28
With Grommet Both	TQ85-T011-B	3180.38	3276.68	3437.76	3544.64	3905.88	4402.54	4667.48	5391.46	4861.66	5786.46
With Handle	TQ85-T011-H	3184.89	3281.19	3442.27	3549.15	3910.39	4407.05	4671.99	5395.97	4866.17	5790.97

The following options require modification of the product number.

- | | |
|---------------------------------------|--|
| Faux Leather | To specify, change the 3rd digit from an 8 to a 3; Example: TQ35-0011 |
| Leather | To specify, change the 3rd digit from an 8 to a 7; Example: TQ75-0011 |
| Stain repellent | To specify, add -P to the end of the product number; Example: TQ85-0011-P (\$78.25 list) |
| Moisture Barrier with Stain Repellent | To specify, add -D to the end of the product number; Example: TQ85-0011-D (add \$123.41 list) |
- For available fabrics, refer to surfaces.haworth.com.

ToDo

Accessories

Important! Specify for a ToDo chair with grommets. Product number suffix must include R, L or B.

Wood Tablet with Arm

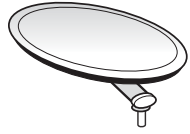

TQ90-0001

Dimensions

W 11.5"(292mm)
L 19.5"(495mm)

To Order, Specify:

- 1) Product number.
- 2) Trim color for arm assembly.
- 3) Wood finish color.

Description	Number	Wood Finish Price
Wood Tablet with Arm	TQ90-0001	\$356.72

Cup Holder



TQ90-0003

Dimensions

W 4.5"(114mm)
L 7"(178mm)

To Order, Specify:

- 1) Product number.
- 2) Trim color for arm assembly.
- 3) Wood finish color.

Description	Number	Wood Finish Price
Cup Holder	TQ90-0003	\$127.94

Grommet Cover



TQ90-0006

To Order, Specify:

- 1) Product number.
- 2) Trim color.

Description	Number	Painted Price
Grommet Cover	TQ90-0006	\$73.76

⚠ Specification Tip:

- A grommet option (suffix R, L or B) must be included in the ToDo chair specification in order to accept table and chair leg holders. Example: TQ85-001R will accept an accessory on the right.

OBSOLETE! / September 2022



Tilt

Stool

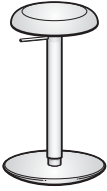
		Number	Price
 <p>STS-1</p>	<p>Dimensions</p> <p>SH: 23.5"-34.75" (597mm-883mm)</p> <p>Seat: 12"(305mm) Diameter</p> <p>Base: 14"(356mm) Diameter</p> <p>Col.: 2"(51mm) Diameter</p>	<p>STS-1</p> <p>Features</p> <ul style="list-style-type: none"> • Base: Overmolded structural urethane covered with steel. • Base is rounded to allow movement and allow user to lean on stool. • Seat: Urethane with an MDF substrate. • Seat available in black only. • Steel column with pneumatic height adjustment. • Available in four trim colors. Black (TR-F), Graphite (TR-J), Accent Orange (TR-1E) or Smooth Plaster (TR-PLS). <p>Specification Tips</p> <ul style="list-style-type: none"> • Plant feet firmly on the floor while leaning on the seat. • Rounded base allows movement in any direction. 	<p>To Order, Specify:</p> <ol style="list-style-type: none"> 1) Product number. 2) Trim color.

Finish/Color Legends

Fern

Trim Colors

TR-F	Black
TR-7	Fog
TR-UFM	Snow

Aluminum Colors

TR-MC	Metallic Champagne
TR-LE	Metallic Silver
TR-TF	Pitch
PM-P	Polished Aluminum

Knit

XQ-1	Baltic Blue
XQ-2	Coastal Grey
XQ-4	Nautical Orange
XQ-5	Ocean Basalt
XQ-6	Seaweed

Mesh

MB-BE	Beach
MB-CL	Coal
MB-CF	Cornflower
MB-LM	Loam
MB-MF	Moon Flower
MB-MU	Mulch
MB-MR	Mushroom
MB-PM	Peat Moss
MB-RR	River Rock
MB-SE	Sedum
MB-SL	Silver Leaf
MB-SU	Sunflower

Harbor Work Lounge

Base

Trim Colors

TR-PLS	Smooth Plaster
TR-F	Black
TR-1E	Accent Orange
PM-P	Polished Aluminum

Cup Holder

Trim Colors

TR-AK	Chalk
TR-F	Black

Tablet Arms

Laminate

H-WL	Linen
H-AA	Putty
H-8J	Charcoal

Veneer

VR-W35	Clear on Walnut
NR-W35	Clear on Rift Cut White Oak

Noble Wing Material

JA-AR	Arctic	JA-FL	Flagstone
JA-BE	Bird's Egg	JA-FG	Fresh Green
JA-CA	Carbon	JA-LG	Light Gray
JA-CT	Citrus	JA-MA	Marinara
JA-CW	Cornwall	JA-GR	Oxford Gray
JA-EM	Ember	JA-PA	Pachyderm
JA-FA	Fawn		

Hello Seating

Trim Colors

TR-LE	Metallic Silver
-------	-----------------

Improv H.E. Chairs/Improv H.E. Stool

Trim Colors

TR-F	Black
TR-J	Graphite
TR-G	Gray Tone

Note: Improv H.E. Chairs with optional high arc base are available in TR-F (Black) trim only.

Improv Series Leg-Base/Sled-Base Chairs and Stools

Trim Colors

TR-F	Black
TR-J	Graphite
TR-G	Gray Tone
TR-E	Smoke

Wood Finish Colors

Maple

M2-CA1	Amber
M2-W23	American
M2-W04	Beech
M2-W33	Carmel
M2-W15	Espresso
M2-W08	Golden Anegre
M2-W07	Light Anegre
M2-N	Natural
M2-W32	Pacific
M2-W31	Retro
M2-AD	Sand

Note:

- Specifying a common stain color for casegoods, wood seating, and wood occasional tables will result in a suite of furniture which has a commercially acceptable finish match.
- Different wood species are offered on the various casegoods, chairs, and tables. Each species offer unique texture, grain, and color of raw wood and veneer. Minor variations in finish color and texture may occur due to these natural characteristics of wood. This is part of the natural beauty of wood and is not considered to be a defect.

Metallic Trim Colors

TR-MC	Champagne
TR-LE	Silver

ALERT: These materials are current, however they are being considered for future obsolescence due to low volume.

Wood Finish Colors

M2-W12	Naturally Walnut
--------	------------------

Maari

Shell / Arm Caps Polymer Colors

TR-1T	Balsam
TR-F	Black
TR-CF	Coffee
TR-G	Gray Tone
TR-1V	Indigo
TR-RR	Rusty Red
TR-PLS	Smooth Plaster
TR-1W	Water
TR-1K	Wren

Sled Base Trim Colors

TR-F	Black
TR-LE	Metallic Silver
TR-RR	Rusty Red
TR-PLS	Smooth Plaster
TR-1K	Wren
KR-V	Chrome

Matte Trim Colors

TR-M1	Black Matte
TR-M2	Smooth Plaster Matte

Four-Leg Trim Colors

TR-F	Black
TR-LE	Metallic Silver
TR-RR	Rusty Red
TR-PLS	Smooth Plaster
TR-1K	Wren

Matte Trim Colors

TR-M1	Black Matte
TR-M2	Smooth Plaster Matte

Wood-Leg Wood Finish

M5-W35	Clear on White Oak
M5-W43	Ink on Oak
M5-W44	Walnut on Oak

Four-Star and Five-Star Base Trim Colors

TR-F	Black
TR-PLS	Smooth Plaster

Matte Trim Colors

TR-M1	Black Matte
TR-M2	Smooth Plaster Matte

Tablet Wood Finish

VH-W35	Plank Walnut
VB-W35	Plank White Oak

Painted MDF

PW-F	Black
PW-PL	Polar

Laminate

Haworth Standard Grade A and Grade B laminate

Finish/Color Legends

Openest

Trim Colors

TR-1E	Accent Orange
TR-F	Black
TR-PLS	Smooth Plaster
TR-RR	Rusty Red

Thread Colors

NS-1E	Accent Orange
NS-F	Black
NS-PLS	Plaster
NS-RR	Rusty Red
NS-SN	Sand

Table Surfaces - Painted

PW-F	Black
PW-PL	Polar
PW-SY	Stormy
PW-VA	Vapor

Sprig Table Surfaces - Wood

VB-W35	Plank White Oak
VH-W35	Plank Walnut

Pip

Trim

Grade A Smooth

TR-R	Beige
TR-AK	Chalk
TR-K	Charcoal
TR-C1	Cocoa
TR-J	Graphite
TR-G	Gray Tone
TR-AA	Putty
TR-E	Smoke
TR-PLS	Smooth Plaster
TR-FM	Snow

Textured

TR-TY	Cement
TR-TG	Grout
TR-TF	Pitch
TR-TW	Plaster

Grade B Smooth

TR-1C	Accent Blue
TR-1D	Accent Green
TR-1E	Accent Orange
TR-1F	Accent Red
TR-1G	Blue Jay
TR-1L	Brindle
TR-1R	Brownstone
TR-CTS	Chartreuse
TR-1N	Night
TR-1Q	Park
TR-RR	Rusty Red
TR-1M	Sable
TR-1P	Seville
TR-1J	Sky Blue
TR-1H	Terra
TR-1K	Wren

Grade B Smooth Metallic

TR-DM	Dark Bronze Metallic
TR-MC	Metallic Champagne
TR-LE	Metallic Silver

Textured Metallic

TR-AL	Alloy
TR-AR	Argent
TR-HE	Hellenic

Surface - Painted MDF

Grade A

PW-R	Beige
PW-F	Black
PW-AK	Chalk
PW-G	Gray Tone
PW-PL	Polar
PW-SY	Stormy
PW-VA	Vapor

Grade B

PW-RR	Rusty Red
PW-1J	Sky Blue
PW-SP	Sparrow
PW-ST	Straw
PW-1H	Terra

Surface - Wood

VB-W35	Plank White Oak
VH-W35	Plank Walnut

Poppy

Guest

Trim Colors

TR-F	Black
TR-PLS	Smooth Plaster

Lounge

Trim Colors

TR-F	Black
TR-1M	Sable
TR-RR	Rusty Red
TR-PLS	Smooth Plaster

Wood Finishes

M5-W35	Clear on Oak
M6-W35	Clear on Walnut
M7-W43	Ink on Ash

Tablet

Wood

VH-W35	Plank Walnut
VB-W35	Plank White Oak

Painted MDF

PW-F	Black
PW-PL	Vapor

Laminate

Haworth Standard
Grade A and Grade B
laminate

Riverbend

Trim Colors

TR-AR	Argent
TR-TF	Pitch (textured)
TR-TW	Plaster (textured)

Soji

Trim Colors

TR-F	Black
TR-7	Fog
TR-UFM	Snow

Knit

XT-1	Carbon
XT-2	Cayenne
XT-3	Clay
XT-4	Juniper
XT-5	Mist
XT-6	Navy
XT-7	Ocean
XT-8	Pumpkin
XT-9	Steel
XT-10	Stone
XT-11	Water

ToDo Seating

Trim Colors

TR-F	Black
TR-M01	Switch Silver

Maple Veneer Finish

M2-CA1	Amber
M2-W23	American
M2-W04	Beech
M2-W33	Carmel
M2-W15	Espresso
M2-W08	Golden Anegre
M2-W30	Heritage
M2-W07	Light Anegre
M2-W21	Mahogany Satin
M2-N	Natural
M2-W32	Pacific
M2-W31	Retro
M2-AD	Sand

ALERT: These materials are current, however they are being considered for future obsolescence due to low volume.

Maple Veneer Finish
M2-W12 Naturally Walnut

Finish/Color Legends

Very Side

Polymer Colors

TR-F	Black
TR-FL	Canvas
TR-FK	Cocoa
TR-CF	Coffee (Perf. Back and Wire Stacker only)
TR-7	Fog
TR-HR	Heron (Perf. Back and Wire Stacker only)
TR-KL	Kale (Perf. Back and Wire Stacker only)
TR-FJ	Slate
TR-FM	Snow
TR-FA	Tomato

Trim Color

TR-F	Black
TR-7	Fog

Base Colors - Painted

TR-F	Black
TR-MC	Metallic Champagne
TR-LE	Metallic Silver
PM-P	Polished Aluminum (conference chair only)
KR-V	Trivalent Chrome (wire stacker, side and seminar)

Base Colors - Plastic (conference chair only)

TR-F	Black
TR-7	Fog

Very Task

Plastic Trim Color

TR-F	Black
TR-7	Fog
TR-UFM	Snow*

Plastic Base

TR-F	Black
TR-7	Fog

Aluminum Base

PM-P	Polished Aluminum
TR-F	Black
TR-MC	Metallic Champagne
TR-LE	Metallic Silver

Aluminum Frame Colors

TR-F	Black
TR-MC	Metallic Champagne
TR-LE	Metallic Silver
TR-FS	Snowfall
PM-P	Polished Aluminum

Knit

XY-1	Cinnamon
XY-2	Jasper
XY-3	Jute
XY-4	Sea Glass
XY-5	Shale

Mesh

MS-F	Black
MS-FK	Cocoa
MS-7	Fog
MS-HR	Heron
MS-KL	Kale
MS-FJ	Slate
MS-FM	Snow

*Arm caps and adjustable levers default to Fog.

X99

Trim Colors

TR-F	Black
KR-V	Chrome*

Metallic Trim Colors

TR-LE	Silver
-------	--------

Mesh

M0-BE	Beach
M0-BL	Black
M0-CA	Camel
M0-FG	Fog
M0-ST	Storm

*Refer to price pages for chrome specification information and upcharge.

Zody, Zody II, Zody LX

Aluminum Base and Arm Uprights

Paint Colors

TR-F	Black
TR-LE	Metallic Silver
TR-MC	Metallic Champagne
PM-P	Polished Aluminum
KR-V	Trivalent Chrome*

Trim Color

TR-F	Black
TR-E	Smoke
TR-UFM	Snow

Wood Back Finish Color

VT-W04	Beech
--------	-------

Plastic Base

TR-F	Black
------	-------

Knit

X4-2	Emerald
X4-3	Moonstone
X4-1	Onyx
X4-4	Rosewood
X4-5	Topaz

Mesh

MA-9	Calm
MA-2	Comfort
MA-5	Gusto
MA-10	Hush
MA-11	Joy
MA-4	Relax
MA-1	Support
MA-12	Tranquil
MA-3	Wellness
MA-13	Zen

*Trivalent chrome available on Zody guest chair only. Refer to price pages for specification information and upcharge.

Finish/Color Legends

Wood Seating — pages 209-210, 244-252 The following matrix shows the standard finish offering for each seating product line. Because of the natural properties of wood, variations of grain pattern and finish color can be expected. Haworth carefully selects materials used in the manufacturing of products to promote consistent and acceptable color. Wood is susceptible to color change from exposure to UV rays. Haworth finishes include a UV stabilizer to reduce these effects. Natural finish on Maple is a clear coat only and will show all the characteristics of the wood.	Wood Seating			
	Composites	Forenze	Hello	ToDo
Maple				
Amber (M2-CA1)*	●	●	●	●
American (M2-W23)	●	●	●	●
Beech (M2-W04)*	●	●	●	●
Caramel (M2-W33)	●	●	●	●
Espresso (M2-W15)*	●	●	●	●
Golden Anegre (M2-W08)	●	●	●	●
Heritage (M2-W30)	●	●	●	●
Light Anegre (M2-W07)	●	●	●	●
Mahogany Satin (M2-W21)*	●	●	●	●
Natural (M2-N)	●	●	●	●
Pacific (M2-W32)	●	●	●	●
Retro (M2-W31)*	●	●	●	●
Sand (M2-AD)*	●	●	●	●

*Compatible wood finish color will complement wood casegoods finish color, not necessarily wood species characteristics.

Wood Seating — page 208 Because of the natural properties of wood, variations of grain pattern and finish color can be expected. Haworth carefully selects materials used in the manufacturing of products to promote consistent and acceptable color. Wood is susceptible to color change from exposure to UV rays. Haworth finishes include a UV stabilizer to reduce these effects.	Wood Seating
	Candor
Beech	
Amber (M3-CA1)	●
American (M3-W23)	●
Caramel (M3-W33)	●
Ebony (M3-RE)	●
Espresso (M3-W15)	●
Golden Anegre (M3-W08)	●
Heritage (M3-W30)	●
Light Anegre (M3-W07)	●
Mahogany Satin (M3-W21)	●
Natural (M3-W04)	●
Pacific (M3-W32)	●
Retro (M3-W31)	●
Sand (M3-AD)	●
Sorrel (M3-RC)	●
Wenge (M3-RW)	●

*Compatible wood finish color will complement wood casegoods finish color, not necessarily wood species characteristics.

ALERT: These materials are current, however they are being considered for future obsolescence due to low volume.

Maple Naturally Walnut M2-W12

Beech Natural Walnut M3-W12

Fabric Pattern Usage

Haworth seating models are restricted to fabric patterns that meet applicability standards for tailoring. A dot in the matrix below indicates fabric acceptability on seating series or specific models listed. Fabrics are listed alphabetically by grades.

Grade: Pattern (Surface Code)	Series/ Model																			
	Fern	Harbor Work Lounge	Hello	Improv H.E.	Improv Leg-Base/Sled-Base Stool - Upholstered Back	Improv Leg-Base/Sled-Base Stool - Plastic Back	Maari	Openest	Openest Pillows	Pebble	Poppy	Riverbend	Soji	ToDo	Very/Very Task	X99	Zody	Zody Guest	Wood (Candor)	Wood (All Other Models)
Haworth Fabrics																				
A: Blanket (4H)	●	●	●	●	●	●	●	●	●	●	●	●	●	●	●	●	●	●	●	●
A: Horizon (1N)	●	●	●	●	●	●	●	●	●	●	●	●	●	●	●	●	●	●	●	●
A: Morse (4J)	●	●	●	●	●	●	●	●	●	●	●	●	●	●	●	●	●	●	●	●
A: Pixel (2A)	●	●	●	●	●	●	●	●	●	●	●	●	●	●	●	●	●	●	●	●
A: Tellure (3A)	●	●	●	●	●	●	●	●	●	●	●	●	●	●	●	●	●	●	●	●
A: Twist (MM)	●	●	●	●	●	●	●	●	●	●	●	●	●	●	●	●	●	●	●	●
A: Wellington Faux Leather (XJ)	●	●	●	●	●	●	●	●	●	●	●	●	●	●	●	●	●	●	●	●
B: Align (4F)	●	●	●	●	●	●	●	●	●	●	●	●	●	●	●	●	●	●	●	●
B: Diagonale (4N)	●	●	●	●	●	●	●	●	●	●	●	●	●	●	●	●	●	●	●	●
B: Element (4Z)	●	●	●	●	●	●	●	●	●	●	●	●	●	●	●	●	●	●	●	●
B: English Tweed (4E)	●	●	●	●	●	●	●	●	●	●	●	●	●	●	●	●	●	●	●	●
B: Floyd by Kvadrat (S6)	●	●	●	●	●	●	●	●	●	●	●	●	●	●	●	●	●	●	●	●
B: Gauge (1X)	●	●	●	●	●	●	●	●	●	●	●	●	●	●	●	●	●	●	●	●
B: Kaleidoscope (S4)	●	●	●	●	●	●	●	●	●	●	●	●	●	●	●	●	●	●	●	●
B: Pemberton (SN)	●	●	●	●	●	●	●	●	●	●	●	●	●	●	●	●	●	●	●	●
B: Ramie (4V)	●	●	●	●	●	●	●	●	●	●	●	●	●	●	●	●	●	●	●	●
B: Reflect by Kvadrat (S8)	●	●	●	●	●	●	●	●	●	●	●	●	●	●	●	●	●	●	●	●
B: Squares (RA)	●	●	●	●	●	●	●	●	●	●	●	●	●	●	●	●	●	●	●	●
B: Tech (MV)	●	●	●	●	●	●	●	●	●	●	●	●	●	●	●	●	●	●	●	●
C: Dots (6K)	●	●	●	●	●	●	●	●	●	●	●	●	●	●	●	●	●	●	●	●
C: King II (67)	●	●	●	●	●	●	●	●	●	●	●	●	●	●	●	●	●	●	●	●
C: Maya II (68)	●	●	●	●	●	●	●	●	●	●	●	●	●	●	●	●	●	●	●	●
C: Oceanic (4T)	●	●	●	●	●	●	●	●	●	●	●	●	●	●	●	●	●	●	●	●
D: Atlas by Kvadrat (LW)	●	●	●	●	●	●	●	●	●	●	●	●	●	●	●	●	●	●	●	●
D: Big Arrow (4D)	●	●	●	●	●	●	●	●	●	●	●	●	●	●	●	●	●	●	●	●
D: Big Diagonale (1K)	●	●	●	●	●	●	●	●	●	●	●	●	●	●	●	●	●	●	●	●
D: Clara 2 by Kvadrat (NV)	●	●	●	●	●	●	●	●	●	●	●	●	●	●	●	●	●	●	●	●
D: Class II (66)	●	●	●	●	●	●	●	●	●	●	●	●	●	●	●	●	●	●	●	●
D: Cotswold (JB)	●	●	●	●	●	●	●	●	●	●	●	●	●	●	●	●	●	●	●	●
D: Main Line Flax (6M)	●	●	●	●	●	●	●	●	●	●	●	●	●	●	●	●	●	●	●	●
D: Melange Nap by Kvadrat (S7)	●	●	●	●	●	●	●	●	●	●	●	●	●	●	●	●	●	●	●	●
D: Recheck by Kvadrat (RP)	●	●	●	●	●	●	●	●	●	●	●	●	●	●	●	●	●	●	●	●
D: Tangram (LV)	●	●	●	●	●	●	●	●	●	●	●	●	●	●	●	●	●	●	●	●
E: Brisa Faux Leather (XG)	●	●	●	●	●	●	●	●	●	●	●	●	●	●	●	●	●	●	●	●
E: Steelcut Trio by Kvadrat (SY)	●	●	●	●	●	●	●	●	●	●	●	●	●	●	●	●	●	●	●	●
F: Divina Melange 3 by Kvadrat (SV)	●	●	●	●	●	●	●	●	●	●	●	●	●	●	●	●	●	●	●	●
F: Hallingdal 65 by Kvadrat (SZ)	●	●	●	●	●	●	●	●	●	●	●	●	●	●	●	●	●	●	●	●
Leathers																				
A: Plains Leather (XP)	●	●	●	●	●	●	●	●	●	●	●	●	●	●	●	●	●	●	●	●
B: Nature Leather (XE)	●	●	●	●	●	●	●	●	●	●	●	●	●	●	●	●	●	●	●	●

*For most current finish and fabric availability please reference surfaces.haworth.com.

ALERT: These materials are current, however they are being considered for future obsolescence due to low volume.

Grade A Horizon (1N)	Grade B Tech (MV)
--------------------------------	-----------------------------

Haworth Fabrics/Color Legend

Haworth+

For information on the Haworth+ alliance program, including images and product availability, please refer to:
Haworth.com > Surface Collection > Haworth+ Library

Customer's Own Material (COM)

For general Customer's Own Material (COM) information including processes and forms, please refer to:
Haworth.com > Surface Collection > Resources > COM

For information on approved COM's, please refer to:
Haworth.com > Surface Collection > COM Library

Seating COM Pattern Repeat Information

Haworth will calculate and order COM yardage as needed for seating; however, for bid/quote purposes, please refer to the COM yardage requirements listed by each chair model. These numbers are based on solid or very small scale (under 1" repeat) fabrics.

For fabrics with repeats listed below, additional yardage should be included in your calculations. The additional yardage allows for matching of patterns on the seating.

REPEAT SIZE	ADD ADDITIONAL YARDAGE TO YOUR CALCULATIONS
1"-4"	Add 5%
5"-7"	Add 10%
8"-14"	Add 20%
15"-19"	Add 25%
20"-27"	Add 30%
28"-36"	Add 50%

COM Yardage Requirements

Procedure

To determine if a COM fabric has been approved for use on Haworth product, contact the Haworth Inquiry Center (1.800.426.8562), your local Haworth dealer, or go to Haworth.com/surfaces > COM Library. Haworth will calculate and order fabric unless instructed otherwise. If the dealer is to provide the fabric, they will calculate the yardage needed themselves.

If the fabric is approved, and the directional orientation (directional rightway, directional railroad, or non-directional) of the tested fabric has been confirmed, then refer to the appropriate price page for yardage requirements.

COM Fabric Requirements

The fabric yardage requirements for COMs given for each model are in lineal yards and are based on 54"(1372mm) usable fabric widths. Approximate yardage requirements are shown for each model within the price pages.

For fabrics already approved, with a COM order entry code assigned, Haworth will determine and purchase the yardage needed. If the fabric will be provided by the dealer, and the pattern has a large repeat or stripes, additional yardage will be needed; see the COM Yardage Requirements at the end of this price guide OR contact the COM Department for more information.

COL Leather Requirements

The leather requirements for COL (Customer's Own Leather) will vary depending on the hide size and are based on square footage. Haworth will determine and purchase the leather needed.

Find total number of linear yards required for the order. Add the appropriate percentage shown below to the total yardage to accommodate fabric flaws, wrinkles and other imperfections.

Up to 500 yards	Add 10%
501 to 1000 yards	Add 5%
More than 1000 yards	Add 3%

Directional Rightway:

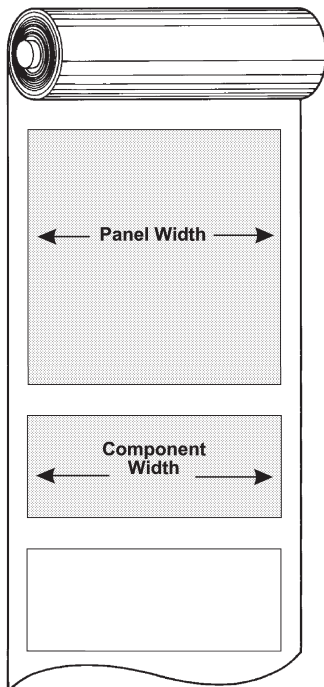
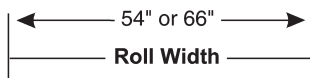

Directional Railroad:

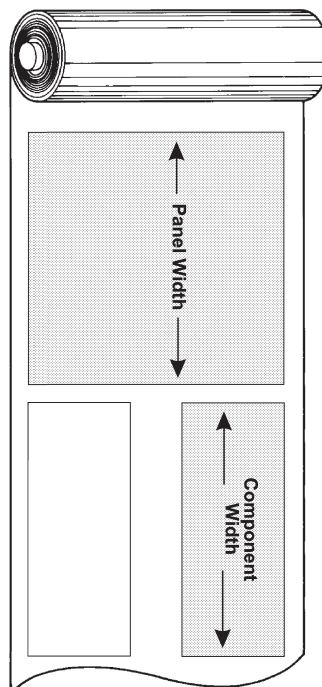
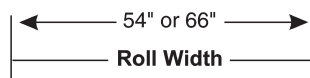

Non-Directional:

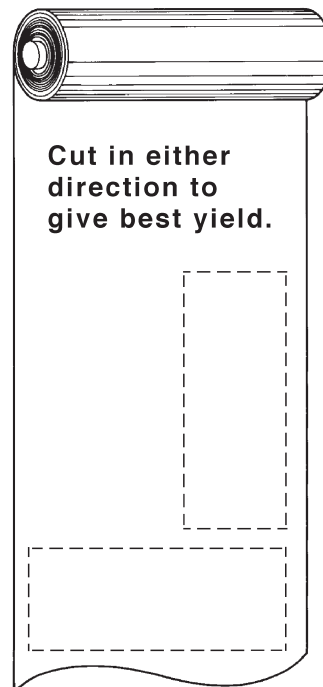
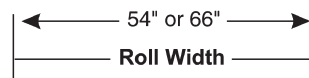

North American Terms of Sale

These Terms of Sale are part of a quotation, bid response, or other sales document issued by Haworth, Inc., Haworth, Ltd. ("Haworth").

These Terms of Sale do not cover products manufactured in North America shipping to non-North American countries nor do they cover products manufactured in non-North American countries shipping to North America. For those terms of sale, please contact Haworth's Global Trade and Compliance Department at 616.393.3000 or through Haworth.com.

A. Ordering Information

Haworth sells its products on the terms set forth in these standard Terms of Sale:

ORDERS MUST BE SUBMITTED IN WRITING OR ELECTRONICALLY (Lynx) AS REPRESENTED BY A VALID PURCHASE ORDER, WHICH INCLUDES PRODUCT TOTAL.

An order is not binding upon Haworth until Haworth issues an order acknowledgment to the customer (the "Customer"), which will include price information and an anticipated delivery date.

1. Order Changes/Cancellations

For Specials, Customer's Own Material (C.O.M.), finish matches, custom colors, custom products, Master lock and key orders, and RUSH orders, no changes or cancellations are allowed 24 hours after order placement. All other products require approval for changes or cancellations. A change/cancellation fee may apply. Contact Order Services for applicable charges.

Ship-to addresses changed within five (5) business days of delivery will incur fees to cover administrative costs due to re-labeling of product and/or reconsignment fees with the carrier.

Order cancellations are complete annulments of orders. Order changes are the deletion of line items or a change in size, color, quantity, ship-to address, or scope of work. There is no penalty for additions; however, any change may cause the order or the line items affected to be rescheduled. Order changes involving additional product and services which increase the value must be accompanied by an amended Purchase Order or other document as agreed.

ALL CHANGES MUST BE IN WRITING, REGARDLESS OF THE (DOLLAR) VALUE. CHANGES ARE NOT BINDING UPON HAWORTH UNTIL HAWORTH ISSUES AN ACKNOWLEDGMENT OF THE CHANGE.

2. C.O.M. (Customer's Own Material)

A Customer who requests a fabric, surface or finish material (C.O.M.) not in Haworth's standard finish offering must first confirm approval of or request new approval for the C.O.M.

Haworth will determine feasibility of the material for manufacturability. For a description of the procedure to submit C.O.M. samples, contact Haworth's Order Services department. For testing information, see the C.O.M. section of the catalog, or call Haworth Order Services.

If Haworth agrees to use the C.O.M., (1) Haworth shall have no responsibility for the condition, quality, value, performance, physical properties, or any other aspect of the C.O.M.; and (2) Haworth shall have no liability for any damages, injuries, or losses to the Customer or to any third party that shall be caused by any C.O.M., and the Customer shall hold Haworth harmless for all such liability.

3. Valid/Complete Purchase Order

The following information is required in order to process an order with Haworth:

a. Customer Information

- i. **Sold To:** Legal name, complete address (if Haworth is to bill the end user, provide end user Purchase Order made out to Haworth, Inc., Haworth, Ltd.) and phone and fax number.
- ii. **Ship To:** Legal name and address.
- iii. **Purchase Order Number:** From the party Haworth will be billing.
- iv. **Authorized Signature:** All Purchase Orders must be signed by a duly authorized representative if a signature line is present. Electronically transmitted Purchase Orders will be accepted without a signature if dealer billed and the dealer has an electronic purchase payment agreement on file.
- v. **Contact Name and Phone Number:** Person Haworth should contact with any questions regarding the order.
- vi. **Shipping Contact:** Name and phone number of person to be contacted regarding shipping and delivery matters.
- vii. **Tagging Instructions:** This information will appear on all documentation received from Haworth including: cartons, acknowledgments, and invoices.
- viii. **Price Agreement or National Sales Agreement Number**
- ix. **Product Total:** Net dollars.
- x. **Installation, Design, Project Management, and/or Service Fees**

b. Product Information

- i. **Quantity**
- ii. **Product Numbers**
- iii. **Colors**
- iv. **Specials:** Specify special part number for new special products.
- v. **Customer's Own Material:** Order entry code, manufacturer, pattern, and color.

- vi. **Approval Drawings:** An authorized signature by a duly authorized representative is required for shop drawings when applicable.
- vii. A deposit may be required for custom materials.

c. Order Confirmation

All orders will be acknowledged.

B. Pricing Policies

1. Terms of Payment

Terms of payment and credit limits will be established based on financial information. Standard payment terms on open credit are net thirty (30) days from invoice date. Advance payments or other payment security may be required by Haworth. The account balance must be at or below the credit limit and current at all times (no past-due balances). Haworth reserves the right to delay or cancel any delivery to a Customer whose Haworth account balance is over the credit limit and/or past due. For walls and floors a deposit will be required.

2. Terms of Credit

Customer hereby authorizes Haworth to obtain such credit reports, financial information or other information as Haworth may request, including, without limitation, credit information from any financial institutions or others having a business relationship with the Customer. Customer hereby authorizes any credit references to answer Haworth's inquiries and provide such credit information and documentation as Haworth may request.

The Customer hereby releases and holds Haworth harmless for any inconvenience whatsoever, caused by any temporary or permanent withdrawal or restriction of credit privileges hereunder, or the enforcement of any of the provisions contained in this paragraph.

3. Past-Due Charges

Past-due balances will be increased by a maximum of 1.5% per month, or 18% annually, without forfeit of Haworth's right to immediate payment.

4. Applicable Prices

The price of any product sold to Customer by Haworth will be based upon the North American Price List (Catalog).

Prices and discounts are subject to change without notice or approval. In the event of an adjustment to pricing, National Sales Agreement (NSA) Customers will be notified in advance according to the terms of the NSA.

Applicable prices and currency exchange rates are those in effect at the time of the RECEIPT of an ORDER; Haworth reserves the right to use the published pricing effective at the time of shipment, if the requested delivery date is more than 120 days after the order receipt date.

North American Terms of Sale

Haworth Flooring products are sold using the North American price list in US dollars. Currency exchange rates at the time of the transaction will be used to convert the USD amount into the alternate currency. Should the currency exchange rate between the USD and alternate currency change between a quote and the receipt of an order, the alternate currency amount will also change to equal the current, equivalent USD amount.

5. C.O.M. (Customer's Own Material) Charges

Refer to appropriate Customer's Own Material (C.O.M.) form for applicable surface material charges.

6. Taxes

Haworth prices do not include customs duty, sales, use, value added or similar taxes. Any federal, state/provincial or other taxes or assessments based upon the sale or delivery of products or services sold applicable to the customer at present or later imposed by federal, state/provincial or municipal agencies, shall be added and paid by the customer. Customer is responsible for all such taxes.

NOTE: For all countries a valid sales tax exemption certificate must be approved by and on file with Haworth prior to product shipment. Otherwise, sales tax will be due and payable to Haworth when such tax is invoiced to Customer.

7. Services

If, as a result of Customer request, the Haworth dealer or Haworth subsidiary provides planning/design services, storage, project management, special handling, set-up, installation and/or other services, the Customer will be charged at the local Haworth dealer/subsidiary's prevailing rates.

8. Termination by Haworth

Haworth may immediately terminate an order upon written notice in the event bankruptcy or insolvency proceedings are instituted by or against the Customer, or the Customer is adjudicated as bankrupt, becomes insolvent, makes an assignment for the benefit of creditors, or proposes or makes any arrangements for the liquidation of its debts, or a receiver or receiver and manager is appointed with respect to all or any part of the assets of the Customer.

C. Shipping and Delivery

Haworth will have the right to determine the method of shipment and routing of product.

If, for any reason, a delivery has to be made to an intermediate location (i.e. a location other than the "Ship To" location noted on the order or ultimate end user location), all handling and re-delivery costs incurred would be at the Customer's expense.

1. U.S.A. - Contiguous

All deliveries will be CPT (Carriage Paid To) (ICC Incoterms 2010) Haworth's manufacturing facilities or distribution centers. Freight charges will be prepaid by Haworth on all orders to locations within the continental United States. Customer bears all risk of loss or damage to the goods when they are placed on Haworth's means of transport.

2. U.S.A. - Non-contiguous (Alaska, Hawaii and Puerto Rico)

All deliveries will be CIF (Cost, Insurance and Freight) (ICC Incoterms 2010). Haworth's catalog prices include ocean freight and insurance to the port of the final destination. Haworth has the right to determine the carrier, method of shipment and routing. Haworth will contract with the insurer and provide minimal insurance coverage (CIF @ 110%) made payable to the Customer. Customer is responsible to obtain greater insurance if so desired.

Customer bears all risk of loss or damage to the goods when the goods are effectively at the disposal of the Customer on board the vessel at the named port of destination. Proof of delivery is a clean on board bill of lading. Customer will be responsible for all on-carriage from the receiving port to the final destination.

3. Canada

All deliveries will be DDP (Delivered Duty Paid) (ICC Incoterms 2010). Haworth's catalog prices include delivery to Customer's named place, not unloaded from any arriving means of transport. Customer bears all risk of loss or damage to the goods when they are delivered to the Customer's named facility not unloaded. Haworth will assume responsibility to file all freight claims with the carrier for any loss/damage which may occur while product is in transit, and will promptly repair or replace any damaged or lost product. Haworth requires the Customer to report all freight damage and/or loss to both the carrier and to Haworth.

NOTE: Under all delivery terms (U.S.A. and Canada), any additional expense resulting from Customer's request for expedited transportation, special services, packaging, handling, routing, and/or shipping method will be billed to Customer.

4. Mexico

All deliveries will be DAP (Delivered to Place) (ICC Incoterms 2010). Haworth's catalog prices include freight charges for normal surface transportation to a United States point of exportation within the 48 contiguous states. Haworth has the right to determine the carrier, method of shipment and routing.

Customer bears all risk of loss or damage to the goods when the goods are delivered to the named United States point of exportation. Haworth will provide customs clearance facilitation and arrangement of local delivery through an Authorized Dealer in Mexico, on a separately negotiated basis. Otherwise the Customer will be responsible for all customs clearance formalities and on-carriage from the United States point of exportation to the final destination in Mexico.

5. Delivery Dates and Delay

If Haworth cannot deliver products as scheduled due to causes beyond its reasonable control (such as casualty, labor disputes, or accident; inability to obtain necessary labor, material or transportation; or changes requested by the Customer), the delivery date will be extended to compensate for the delay as determined by Haworth.

6. Delivery Shortages and Damage

Product shortages and damage must be noted on delivery receipts at the time of delivery and reported to the carrier for correction.

Claims against Haworth for shortages, errors, or damage must be made within ten (10) days of the date of delivery or the Customer waives the right to make such a claim. Signed Bill of Ladings or Delivery Receipt must be sent in with claims. See the Haworth/Haworth Dealers Roles and Responsibilities document for further details.

7. Storage

Haworth may transfer product to storage at the Customer's risk and expense if the Customer is unable or unwilling to take delivery of product as originally scheduled. Upon such transfer to storage, the Customer assumes risk of loss. Haworth will invoice the Customer for storage fees and the Customer will make payments in accordance with Haworth's standard payment terms.

North American Terms of Sale

D. General Terms

1. Governing Law

For products purchased for delivery in the U.S. pursuant hereto, this Agreement shall be governed by and construed according to the laws of the State of Michigan. Where Products are purchased for delivery in Canada pursuant hereto, this Agreement shall be governed by and construed according to the laws of the Province of Alberta. In either case, the parties attorn to the exclusive jurisdiction of the courts of Michigan and Alberta, respectively for the purpose of hearing any disputes arising under this Agreement or with respect to any Products sold pursuant hereto, and agree that the provisions of the United Nations Convention on Contracts for the International Sale of Goods and any other provision or law which would have the effect of applying the laws of any jurisdiction other than Michigan or Alberta, as the case may be, shall be excluded.

2. Force Majeure

In the event that the performance of Customer or Haworth or its participating dealer assignee(s) would be prevented, restricted, interfered with or rendered commercially impracticable by reason of Force Majeure, then upon the giving of notice to the other parties, the party affected by the Force Majeure shall be excused from performing hereunder until the Force Majeure no longer prevents, restricts, interferes with, or renders such performance commercially impracticable.

"Force Majeure" shall mean: fire, explosion, breakdown of plant, epidemic, hailstorm, snow/ice storms en route, hurricane, tornado, cyclone, flood or power failure; war, revolution, civil or military disturbances, acts of public enemies, acts of terrorism, blockade or embargo; any law, order, proclamation, regulation, ordinance, demand or requirement of any applicable governmental authority or any subdivision, authority, or representative of any such government; labor difficulties, including without limitation, strikes, slowdowns, picketing or boycotts; or difficulties beyond Haworth's reasonable control in obtaining necessary raw materials, labor, fuels and electric power, components or facilities, and any other circumstances beyond the control of the party affected.

3. Delays by Customer

Where Haworth has not received adequate site dimensions, Product specifications, shipping information, installation particulars or other information required by Haworth to permit the efficient manufacture of any Products, or where site conditions are not in accordance with the Installation Requirements set forth, or are not otherwise suitable to permit effective and efficient installation, the manufacture and/or delivery of Products may be delayed, and such event shall constitute a delay by the Customer. When manufacture, delivery or installation is delayed by the Customer or at the Customer's request: (i) Haworth may, at its option, present the invoice for the full price of the Products to the Customer as then due and payable; (ii) the Customer shall pay to

Haworth all reasonable storage, handling and other reasonable incidental expenses incurred by Haworth in connection with such delay; and (iii) the Customer shall bear all risk of loss or damage to the Products being held by Haworth for the Customer.

4. Use and Installation of Products

Haworth recommends that its products be installed by certified, qualified and approved installers according to Haworth's written installation procedures. The Customer agrees to use Haworth products properly; not to remove or alter safety devices, warnings, or operation instructions placed on products by Haworth, and to instruct employees as to the proper care and use of the products according to printed instructions.

5. Warranty

Haworth's standard North American Warranty will apply as appropriate. All product line warranty specifics are available in each catalog or upon request.

E. Services

Service requests for design, installation, relocation, storage, etc. are handled by the local Haworth dealer on a separately negotiated basis. Contact the local Haworth dealer, affiliate or area sales office for more details.

Scope of Work - Design

Customer acknowledges that the Products to be manufactured or procured by Haworth in connection with the order are or may be custom manufactured for the Customer and that Haworth may be required to perform extensive work in relation to the design and specification of such Products. Where Customer requests that Haworth create as-built drawings or make more than two material revisions to any particular Product design or specification, Customer agrees that Haworth shall be entitled to invoice Customer with respect to such additional work on the basis of Haworth's then prevailing rates for related design and specification services.

Installation Requirements

Where installation services are to be provided by Haworth, its authorized dealer or subcontractor, a document will be provided setting forth the scope of installation work to be performed (the "Scope of Work") and the price to be charged therefore. Unless otherwise specified in the scope of work, Haworth's installation services are limited to products sold by Haworth with the exception of lighting, under floor electrical and data.

General Conditions

(a) Sufficient time shall be allocated by the Customer following delivery of Products and prior to Customer's occupation of the premises to allow the installation of all Products during conventional working hours, Monday through Friday, 7:30 a.m. to 4:30 p.m. Where sufficient time is not allocated and Haworth is required or requested to perform installation work outside of such times, overtime charges shall be charged at Haworth's then prevailing rates. (b) Haworth shall be given free and exclusive access to; (i) a loading dock within 150' of the freight elevator or hoist, which loading dock shall be of sufficient size to enable full-size tractor-trailer deliveries to the premises (where required by Haworth); (ii) a freight elevator or hoist of sufficient size and capacity to allow the efficient movement of the Products; (iii) an unobstructed and safe pathway to the area where Products are to be stored or staged; (iv) a secure storage / staging area; (v) convenient trash facilities; (vi) adequate lighting; (vii) a work site that complies with applicable health and safety legislation. Where such areas and facilities are not available, Haworth shall be entitled to bill Customer for all amounts incurred by Haworth for double-handling, product movement, lifting, hoisting, trash removal and any other resulting charges. (c) The installation site shall be free and clear of existing furniture, debris, or other obstructions (including construction in progress) and shall otherwise be in the reasonable opinion of Haworth ready for installation of the Products. Any building where Products are to be installed shall be fully closed in, dry and protected from the natural elements, with temperatures between 40°F and 90°F (4°C and 32°C) and relative humidity not to exceed 70% at all times including receipt of products, during and after installation and shall be adequately heated and/or air-conditioned. Where unusual site conditions exist which impede or prevent the normal installation of any Products, applicable extra charges shall apply at prevailing rates. (d) Haworth's installation pricing is based upon the installation occurring as one continuous delivery and installation project. Phased installation pricing shall be provided by Haworth on a case by case basis. (e) Electrical hardwiring, plumbing and mechanical work is not included and shall be the responsibility of the Customer. (f) Except as may be otherwise specifically indicated, installation pricing does not apply to projects where union labor is required. Where Haworth has provided installation pricing on the basis that non-union labor be utilized, and where Haworth is required to use union labor or it otherwise becomes impractical to use non-union labor, or where Haworth is required by law to use prevailing wages, Haworth shall be entitled to charge the Customer for any cost differential between the anticipated cost of non-union labor and the actual cost of utilizing union or prevailing wage labor. (g) Haworth shall not be responsible for obtaining permits.

North American Terms of Sale

Project / Site Conditions

Lateral load bracing is not included in the scope of Haworth's work and shall not be performed by Haworth. In areas where flooring Products are to be installed by Haworth overhead construction must be completed prior to the commencement of such work to avoid damage to the panels and finishes. The existing subfloor must be smooth, mopped clean, free of moisture, dust, dirt and debris. Once installed, the access floor must be maintained in the same manner. The subfloor must have a maximum vertical elevation deviation of 0.375" (10mm) over a horizontal span of 10'-0" (3m), and without discontinuities in floor slope. For greater certainty, the scope of Haworth's installation work in such areas shall not be deemed to include any work required to level such subfloor, remove protrusions, remove pre-existing floor coverings or adhesives, or any other work which is required to remedy any conditions which may impede the efficient installation of flooring. Except as may be otherwise specifically indicated in the order, installation pricing for flooring Products and the Scope of Work in relation thereto shall not include any work required to remove and replace floor panels following their initial installation to provide tradespersons or others with access to the underpanel cable management cavity. In areas where movable walls are to be installed, all flooring (including carpeting) and ceiling components (including dropped ceiling grid components) shall be fully complete and ready for the installation of the movable wall products. Further, the existing floor (or other surface on which the movable wall panels are to be installed) shall have a maximum vertical deviation of 1.25" (30mm) and the dropped ceiling grid shall have a maximum vertical deviation of 0.375" (10mm) from the specifications to which such movable wall panels were designed and manufactured (collectively the "Permitted Tolerances"), and shall otherwise comply with any site condition assumptions made known to Haworth prior to the manufacture of such Products (the "Site Assumptions"). Where the Permitted Tolerances or Site Assumptions are not strictly adhered to or met, additional charges may be incurred in connection with site remediation and/or the modification or remanufacture of affected movable wall products, together with all resulting shipping and labor charges at Haworth's then prevailing rates for such Products and services.

Installation Change Orders

Where Customer requests work to be performed or materials to be provided which are not contemplated in the Scope of Work, or Customer otherwise requests Products or services not contemplated in the order (collectively "Extras"), prior to providing such Extras Haworth reserves the right to require the Customer to provide and sign a written Purchase Order or Change Order acceptable to Haworth describing the Extras and the amounts to be charged therefore, and the Customer agrees to pay such charges.

Entire Agreement

The order and this Agreement (including applicable Schedules) constitute the sole agreement between the parties and supercede any prior understanding or written or oral agreements between the parties (excluding National Sales Agreements). No waiver of any of the provisions of these Standard Terms and Conditions shall be binding on Haworth unless expressly agreed in writing.

Revision Date: April 1, 2019

Products are listed alphabetically in this index by alpha-numeric prefix/suffix codes.

Product Code	Product Description	Page
4045-00	Composites Seating Series – Arc Arm, Upholstered Back	.209
4049-00	Composites Seating Series – Stool, Armless, Upholstered Back	.209
4851-0011-W	Hello Seating – Fixed Arm, Wood Legs	.247
4851-0012-W	Hello Seating – Fixed Arm, Wood Legs	.247
4851-0013-W	Hello Seating – Fixed Arm, Wood Legs	.247
4854-0011	Hello Seating – Lounge Chair – Standard Arm	.244
4855-0043	Hello Seating – One Color – Standard Arm	.245
4855-0043-GX	Hello Seating – Fully Loaded – Standard Arm	.245
4856-0043	Hello Seating – Mini-mobile	.246
4858-0001	Hello Seating – Accessories	.246
4858-0002	Hello Seating – Accessories	.246
8184-00	Forenze Seating – Cabriole Arm, Upholstered Back	.210
8484-00	Forenze Seating – Cabriole Arm, Slat Back	.210
EUSM-HF0W-1100	Power Module – Hardwire	.226
EUSM-HF0W-2100	Power Module – Hardwire	.226
EUSM-HLOW-1100	Power Module – Hardwire	.226
EUSM-HLOW-2100	Power Module – Hardwire	.226
EUSM-PF0W-1100	Riverbend Power Module – Corded	.226
EUSM-PF0W-2100	Riverbend Power Module – Corded	.226
EUSM-PL0W-1100	Riverbend Power Module – Corded	.226
EUSM-PL0W-2100	Riverbend Power Module – Corded	.226
M231-1042	Improv Series – Without Arms	.167
M231-1442	Improv Series – With Task Arms	.163
M231-1742	Improv Series – With Height Adjustable Task Arms	.164
M231-1H42	Improv Series – With Flipper Arms	.165
M231-1W42	Improv Series – With Height and Width Adjustable 3-D Arms	.166
M251-1042	Improv Series – Without Arms	.162
M251-1442	Improv Series – With Task Arms	.158
M251-1742	Improv Series – With Height Adjustable Task Arms	.159
M251-1H42	Improv Series – With Flipper Arms	.160
M251-1W42	Improv Series – With Height and Width Adjustable 3-D Arms	.161
M271-1042	Improv Series – Without Arms	.157
M271-1442	Improv Series – With Task Arms	.154
M271-1742	Improv Series – With Height Adjustable Task Arms	.155
M271-1H42	Improv Series – With Flipper Arms	.156
M2E1-1042	Improv Series – Without Arms	.172
M2E1-1442	Improv Series – With Task Arms	.168
M2E1-1742	Improv Series – With Height Adjustable Task Arms	.169
M2E1-1H42	Improv Series – With Flipper Arms	.170
M2E1-1W42	Improv Series – With Height and Width Adjustable 3-D Arms	.171
M600-2100	Improv Series – Without Arms	.174
M600-2110	Improv Series – With Arms	.173
M600-2300	Improv Series – Without Arms	.174
M600-2310	Improv Series – With Arms	.173
M600-8100	Improv Series – Without Arms	.177
M600-8110	Improv Series – With Arms	.177
M600-8300	Improv Series – Without Arms	.177

Index

Product Code	Product Description	Page
M600-8310	Improv Series – With Arms	177
M601-2100	Improv Series – Without Arms, Non-Stacking	176
M601-2110	Improv Series – With Arms, Non-Stacking	175
M601-2300	Improv Series – Without Arms, Non-Stacking	176
M601-2310	Improv Series – With Arms, Non-Stacking	175
MPRV-BARS	Improv Series – Chair-to-Chair Connecting Bars	178
MPRV-CART	Improv Series – Stacking Dolly	178
S74-22-0H	Maari – Without Arms	197
S74-22-1H	Maari – With Arms	196
S74-24-0H	Maari – Without Arms	197
S74-24-1H	Maari – With Arms	196
S74-44-0H	Maari – Without Arms	197
S74-44-1H	Maari – With Arms	196
S75-22-01	Maari – Without Arms	199
S75-22-11	Maari – With Arms	198
S75-24-01	Maari – Without Arms	199
S75-24-11	Maari – With Arms	198
S75-44-01	Maari – Without Arms	199
S75-44-11	Maari – With Arms	198
S7H-22-0H	Maari – Without Arms	192
S7H-22-1H	Maari – With Arms	191
S7H-24-0H	Maari – Without Arms	192
S7H-24-1H	Maari – With Arms	191
S7H-44-0H	Maari – Without Arms	192
S7H-44-1H	Maari – With Arms	191
S7HB-22-0H	Maari – Standard Back	200
S7HB-24-0H	Maari – Standard Back	200
S7HB-44-0H	Maari – Standard Back	200
S7HC-22-0H	Maari – Standard Back	200
S7HC-24-0H	Maari – Standard Back	200
S7HC-44-0H	Maari – Standard Back	200
S7S-22-0H	Maari – Without Arms	194
S7S-22-11	Maari – With Arms	193
S7S-24-0H	Maari – Without Arms	194
S7S-24-11	Maari – With Arms	193
S7S-44-0H	Maari – Without Arms	194
S7S-44-11	Maari – With Arms	193
S7SB-22-0H	Maari – Without Arms	203
S7SB-22-1H	Maari – With Arms	202
S7SB-24-0H	Maari – Without Arms	203
S7SB-24-1H	Maari – With Arms	202
S7SB-44-0H	Maari – Without Arms	203
S7SB-44-1H	Maari – With Arms	202
S7SC-22-0H	Maari – Without Arms	203
S7SC-22-1H	Maari – With Arms	202
S7SC-24-0H	Maari – Without Arms	203
S7SC-24-1H	Maari – With Arms	202
S7SC-44-0H	Maari – Without Arms	203
S7SC-44-1H	Maari – With Arms	202

Index

Product Code	Product Description	Page
S7W-22-0H	Maari – Without Arms	195
S7W-24-0H	Maari – Without Arms	195
S7W-44-0H	Maari – Without Arms	195
S7WB-22-0H	Maari – Standard Back	204
S7WB-24-0H	Maari – Standard Back	204
S7WB-44-0H	Maari – Standard Back	204
S7WC-22-0H	Maari – Standard Back	204
S7WC-24-0H	Maari – Standard Back	204
S7WC-44-0H	Maari – Standard Back	204
S8HB-24-0H	Maari – Low Back	201
S8HC-24-0H	Maari – Low Back	201
S8WB-24-0H	Maari – Low Back	205
S8WC-24-0H	Maari – Low Back	205
SAS-22-A1A	Candor Modern Seating – Fully Upholstered Seat and Back	208
SAS-22-A3A	Candor Modern Seating – Fully Upholstered Seat and 1/2 Back	208
SCB-44-0H	Very – Seminar With Storage Rack	120
SCB-44-3H	Very – Seminar With Storage Rack	120
SCC-44-01	Very – Without Arms	123
SCC-44-11	Very – With Arms	122
SCF-44-01	Very – Without Arms	124
SCF-44-11	Very – Without Arms	124
SCH-44-0S	Very – Without Arms	107
SCH-44-3S	Very – With Arms	106
SCHA-R	Very – Wire Stacker Tablet Arm	125
SCHR-1	Very – Wire Stacker Storage Rack	125
SCK-44-3H	Very – Side Chair With Storage Rack	114
SCL-44-0H	Very – Without Arms	115
SCL-44-3H	Very – With Arms	115
SCLC-44-0H	Very – Without Arms	116
SCLC-44-3H	Very – With Arms	116
SCM-44-0H	Very – Without Arms	118
SCM-44-3H	Very – With Arms	117
SCM-44-RH	Very – Seminar With Tablet Arm	119
SCS-44-0H	Very – Without Arms	112
SCS-44-3H	Very – With Arms	111
SCS-44-RH	Very – Side Chair With Tablet Arm	113
SCSG-1	Very – Ganging Connector	125
SCSG-2	Very – Ganging Connector	125
SCT-1	Very – Stacking Carts	126
SCT-20-0011	Very Task – Task Chair without Arms	94
SCT-20-1011	Very Task – Task Chair with Fixed Arms	92
SCT-20-4011	Very Task – Task Chair with Height Adjustable Arms	90
SCT-20-7011	Very Task – Task Chair with 4D Arms	88
SCT-20-7115	Very Task Value Model	87
SCT-3	Very – Stacking Carts	126
SCT-4	Very – Stacking Carts	126
SCTC-20-0011	Very Task – Task Stool without Arms	102
SCTC-20-1011	Very Task – Task Stool with Fixed Arms	100
SCTC-20-4011	Very Task – Task Stool with Height Adjustable Arms	98

Index

Product Code	Product Description	Page
SCTC-20-7011	Very Task – Task Stool with 4D Arms	96
SCW-44-0S	Very – Bar Height Wire Stool	108
SCW-44-3S	Very – Bar Height Wire Stool	108
SCWC-44-0S	Very – Counter Height Wire Stool	109
SCWC-44-3S	Very – Counter Height Wire Stool	109
SFS-U0-0N01A	Fern – Task Stool without Arms — Aluminum Base Model	38
SFS-U0-0N01A	Fern – Task Stool without Arms — Plastic Base Model	37
SFS-U0-1S01A	Fern – Task Stool with Fixed Arms — Aluminum Base Model	36
SFS-U0-1S01A	Fern – Task Stool with Fixed Arms — Plastic Base Model	35
SFS-U0-4S01A	Fern – Task Stool with Height Adjustable Arms — Aluminum Base Model	34
SFS-U0-4S01A	Fern – Task Stool with Height Adjustable Arms — Plastic Base Model	33
SFS-U0-7S01A	Fern – Task Stool with 4D Arms — Aluminum Base Model	32
SFS-U0-7S01A	Fern – Task Stool with 4D Arms — Plastic Base Model	31
SFT-U0-0N01A	Fern – Task Chair without Arms — Aluminum Base Model	30
SFT-U0-0N01A	Fern – Task Chair without Arms — Plastic Base Model	29
SFT-U0-1S01A	Fern – Task Chair with Fixed Arms — Aluminum Base Model	28
SFT-U0-1S01A	Fern – Task Chair with Fixed Arms — Plastic Base Model	27
SFT-U0-4S01A	Fern – Task Chair with Height Adjustable Arms — Aluminum Base Model	26
SFT-U0-4S01A	Fern – Task Chair with Height Adjustable Arms — Plastic Base Model	25
SFT-U0-7S01A5	Fern Value Model – Task Chair with 4D Arms — Plastic Base Model	22
SFT-U0-7S01A	Fern – Task Chair with 4D Arms — Aluminum Base Model	24
SFT-U0-7S01A	Fern – Task Chair with 4D Arms — Plastic Base Model	23
SHL-22-1R10	Harbor Work Lounge – Lounge Chair	240
SHL-22-1R12	Harbor Work Lounge – Lounge Chair	240
SHL-25-1L10	Harbor Work Lounge – Lounge Chair	242
SHL-25-1L12	Harbor Work Lounge – Lounge Chair	242
SHO-22-G	Harbor Work Lounge – Ottoman	241
SHO-25-G	Harbor Work Lounge – Ottoman	243
SJT-20-011A	Soji – Task Chair without Arms — Aluminum Base	140
SJT-20-011A	Soji – Task Chair without Arms — Plastic Base	139
SJT-20-111A	Soji – Task Chair with Fixed Arms — Aluminum Base	138
SJT-20-111A	Soji – Task Chair with Fixed Arms — Plastic Base	137
SJT-20-401X	Soji – Task Chair with Height Adjustable Arms — Plastic Base	135
SJT-20-411X	Soji – Task Chair with Height Adjustable Arms — Aluminum Base	136
SJT-20-711A	Soji – Task Chair with 4D Arms — Aluminum Base	134
SJT-20-711A	Soji – Task Chair with 4D Arms — Plastic Base	133
SJTC-001A	Soji – Task Stool without Arms — Aluminum Base	148
SJTC-001A	Soji – Task Stool without Arms — Plastic Base	147
SJTC-001X	Soji – Task Stool without Arms — Aluminum Base	148
SJTC-001X	Soji – Task Stool without Arms — Plastic Base	147
SJTC-101A	Soji – Task Stool with Fixed Arms — Aluminum Base	146
SJTC-101A	Soji – Task Stool with Fixed Arms — Plastic Base	145
SJTC-101X	Soji – Task Stool with Fixed Arms — Aluminum Base	146
SJTC-101X	Soji – Task Stool with Fixed Arms — Plastic Base	145
SJTC-401A	Soji – Task Stool with Height Adjustable Arms — Aluminum Base	144
SJTC-401A	Soji – Task Stool with Height Adjustable Arms — Plastic Base	143
SJTC-401X	Soji – Task Stool with Height Adjustable Arms — Aluminum Base	144
SJTC-401X	Soji – Task Stool with Height Adjustable Arms — Plastic Base	143
SJTC-701A	Soji – Task Stool with 4D Arms — Aluminum Base	142

Index

Product Code	Product Description	Page
SJTC-701A	Soji – Task Stool with 4D Arms — Plastic Base	141
SJTC-701X	Soji – Task Stool with 4D Arms — Aluminum Base	142
SJTC-701X	Soji – Task Stool with 4D Arms — Plastic Base	141
SLP-22-R	Poppy – Swivel	238
SLP-22-S	Poppy – Swivel	238
SLP-22-T	Poppy – Basket	238
SMCH-2256-HS	Riverbend – 90°	220
SMCH-2258-HS	Riverbend – 60°	221
SMCM-2256-HS	Riverbend – 90°	220
SMCM-2258-HS	Riverbend – 60°	221
SMCN-2056-HS	Riverbend – 90°	220
SMCN-2058-HS	Riverbend – 60°	221
SMG-1	Riverbend Accessories – Ganging Bracket	225
SMQM-2240-H	Riverbend – Corner – Square	223
SMQN-2040-H	Riverbend – Corner – Square	223
SMSH-2255-H	Riverbend – Double Seat	218
SMSH-2267-H	Riverbend – Triple Seat	219
SMSM-2228-H	Riverbend – Single Seat	217
SMSM-2255-H	Riverbend – Double Seat	218
SMSM-2267-H	Riverbend – Triple Seat	219
SMSN-2028-H	Riverbend – Single Seat	217
SMSN-2055-H	Riverbend – Double Seat	218
SMSN-2067-H	Riverbend – Triple Seat	219
SMVH-2258-HS	Riverbend – 60° Convex	222
SMVM-2258-HS	Riverbend – 60° Convex	222
SODB-2424-P	Openest Collection – Round	232
SODC-1616-P	Openest Collection – Round	232
SON-3	Openest Collection – Plume 3	227
SON-6	Openest Collection – Plume 6	227
SON-9	Openest Collection – Plume 9	227
SOPB-2223	Openest Collection – Chick Pouf with Back	229
SOPN-2223	Openest Collection – Chick Pouf without Back	229
SOPN-2238	Openest Collection – Large Square - No Back	230
SOPN-2252	Openest Collection – Rectangle - No Back	230
SOPN-2265	Openest Collection – Round - No Back	231
SORA-5320-P	Openest Collection – Rectangle	232
SO5R-1-RW	Openest Collection – Feather – Asymmetrical	228
SO5S-1-RW	Openest Collection – Feather – Symmetrical	228
SPG-11-4	Poppy – Four Star Base with Glides	236
SPG-11-5	Poppy – Five Star Base with Casters	236
SPG-11-7	Poppy – Sled Base	237
SPG-11-W	Poppy – Wood Base	237
STP-P26-TH	Pip – Personal Laptop Table	233
STS-1	Tilt – Stool	253
STSN-2025-HN	Pebble – Ottoman	224
STSN-2033-HN	Pebble – Ottoman	224
STSN-2047-HN	Pebble – Ottoman	224
STSN-2067-HN	Pebble – Ottoman	224
SZG-22-1	Zody – 4 Leg	79

Index

Product Code	Product Description	Page
SZG-22-1	Zody – Sled Base	78
SZT-20-002MA1	Zody – Task Chair without Arms	59
SZT-20-102MA1	Zody – Task Chair with Fixed Arms	55
SZT-20-402MA1	Zody – Task Chair with Height Adjustable Arms	51
SZT-20-702MA1	Zody – Task Chair with 4D Arms	47
SZT-20-711MA5	Zody Value Model – Task Chair with 4D Arms	46
SZTC-20-002MA1	Zody – Task Stool without Arms	75
SZTC-20-102MA1	Zody – Task Stool with Fixed Arms	71
SZTC-20-402MA1	Zody – Task Stool with Height Adjustable Arms	67
SZTC-20-702MA1	Zody – Task Stool with 4D Arms	63
TQ84-0011	ToDo – Single, Stationary	250
TQ85-0011	ToDo – Single, Mobile	251
TQ90-0001	ToDo – Wood Tablet with Arm	252
TQ90-0003	ToDo – Cup Holder	252
TQ90-0006	ToDo – Grommet Cover	252
X630-3100	X99 – Guest Chair	183
X640-0040	X99 – Without Arms	185
X641-2040	X99 – Without Arms	187
X641-2140	X99 – With Arms	186
X840-0140	X99 – With Arms	184

Great Expectations

You have them as a Haworth customer and so do we. And because we value our customers, we cover our products with the Haworth North America Product Compatibility and Limited Warranty Policy.

Product Compatibility and Limited Warranty Policy

Our Commitment To Product Compatibility – Integrated Product Platforms

As a market leader in the design and manufacture of workspaces that adapt to change, we strive to maintain product compatibility within our various generations of integrated product platforms. This benefits the customer who desires to update or modify their work environment. It also benefits the customer needing to replace a product due to damage or other reasons but which is no longer manufactured or is otherwise unavailable, such as a fabric or finish that is discontinued because of changing market preferences. In both circumstances, we often can provide products with comparable function and performance.

Our Commitment To Product Quality – The Haworth North America Limited Warranty

To ensure customer satisfaction and peace of mind, we stand behind our products with the Haworth North America Limited Warranty. To review the current version of the limited warranty including its terms and conditions, please go to:

www.haworth.com/na/en/resources/warranty.html or contact OneTouch@Haworth.com or 1 877 429 6784.

Warranty Requests or Questions

For questions or service requests pertaining to the Haworth Limited Warranty, please contact your Haworth dealer.

If you are unsure who your dealer is, please contact **OneTouch@Haworth.com or 1 877 429 6784.**

Effective: August 1, 2022

HAWORTH

HAWORTH® is a registered trademark of Haworth, Inc.
© Haworth, Inc. All rights reserved. 2021 2.21 | Item #0004
haworth.com | 800 344 2600

Veda
General Specifications

Veda by Danielle Gollinucci

A light-scale, multipurpose chair providing essential comfort across a breadth of applications. Flexible yet supportive - its flawless curvature and minimal mass convey form and function rooted in decades of Italian design heritage.

General Guidelines for Product Specification

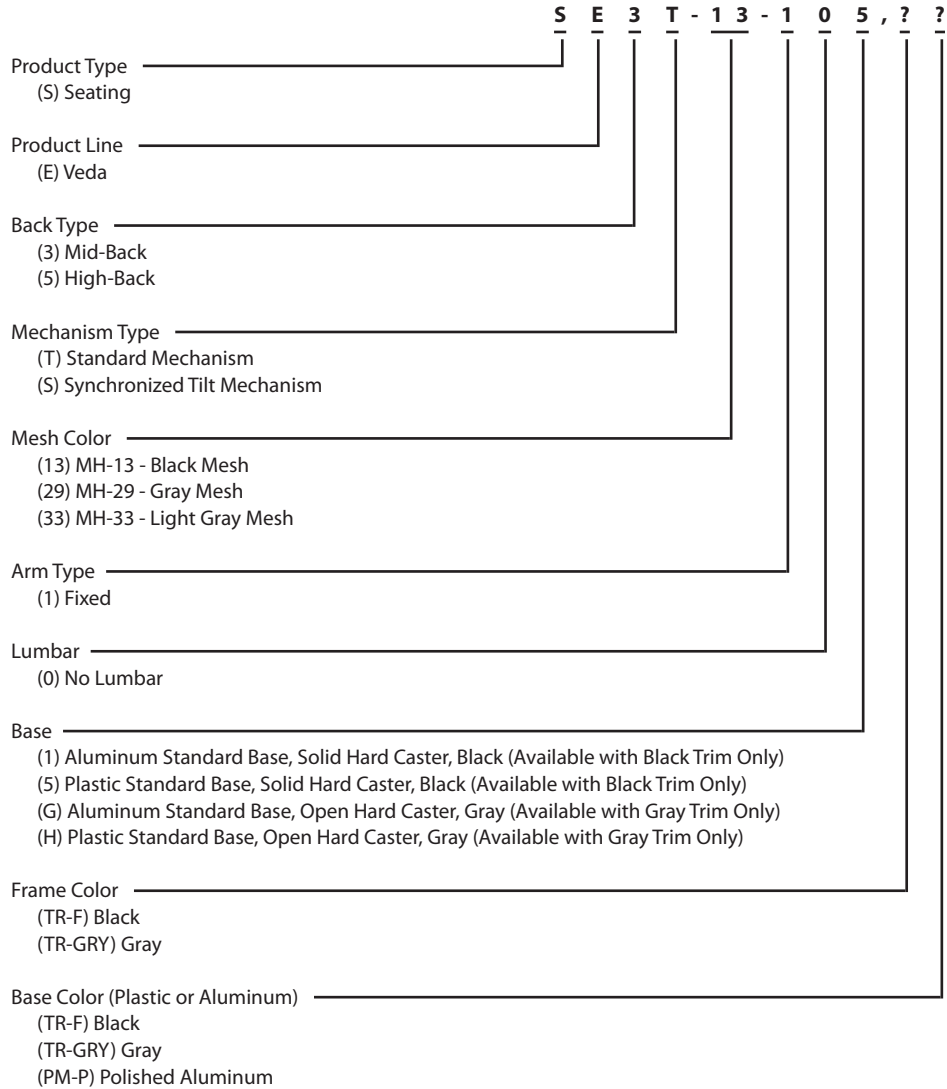

Veda At-A-Glance

General Specifications

Seat Height Adjustment

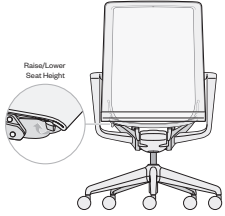

Features:

- Pneumatic seat height adjustment.
- Seat height adjusts from 16.7" to 20.9"H(424mm-531mm).

Benefits:

- Ensures comfort of lower limbs by avoiding pressure on the underside of the thigh caused by a seat that is too high, or decreased thigh-to-torso angle if the seat is too low.
- Seat height adjustment is important in setting the proper hand position and allowing for proper sitting eye height as well.

Standard Tilt



Features:

- Weight assisted recline mechanism tilts backward 14° from upright position.
- Available on the Mid-Back chair only.

Benefit:

- Provides essential comfort without complicated adjustments.

Synchronized Tilt

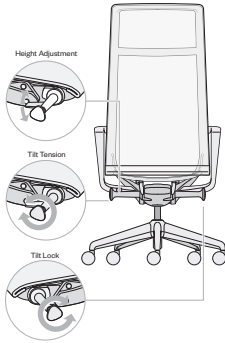

Features:

- One piece mesh construction with patented hinge system allows for synchronized recline at a 2:1 ratio.
- Standard with tilt tension adjustment - accommodating full range of tension within one complete revolution.
- Standard with five position tilt lock, four back and one upright position.
- Available on both Mid-Back and High-Back chair.

Benefits:

- Comfortable, relaxed posture while keeping your feet on the ground.
- Recline allows for the opening of the user's chest cavity.
- Allows user the opportunity to vary their posture throughout the day.

Base

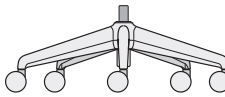

Features:

- Plastic or aluminum.
 - Plastic: Black or Gray
 - Aluminum: Polished Aluminum only
- Plastic base color must match frame color.

Casters

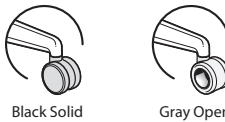

Features:

- Hard casters only.
- Caster style and color determined by frame color.
 - Black frame: Black solid casters.
 - Gray frame: Gray open casters.

Veda
Mid-Back Chair

Standard Tilt



SE3T

Dimensions

- *SH: 16.7"-20.9"
(424mm-531mm)
- H: 40.3"-44.5"
(1024mm-1130mm)
- D: 27.5"(699mm)
- W: 27.5"(699mm)
- *SW: 19.6"(498mm)
- *SD: 16.8"(427mm)
- *AH: 8.6"(218mm)

* Measurements taken with the BIFMA chair measuring device.

Features

- Back and Seat: One piece mesh construction.
- Black Mesh and Frame.
- Base: Plastic or aluminum five-star base.
–Plastic base available in Black.
–Aluminum base available in Polished Aluminum.
- Arms: Fixed height arms.
- Casters: Solid hard casters in black.
- Weight assisted recline mechanism.
- Back tilts backward 14° from upright position.
- COM/COL not available.
- **Ships KD and requires tool-less assembly.**

To Order, Specify:

- 1) Product number
- 2) Frame color.
TR-F Black
- 3) Base color.
Plastic - TR-F Black
Aluminum - PM-P Polished Aluminum

Description	Number	Price
Plastic Base		
Black Mesh / Black Frame	SE3T-13-105	\$ 955.00
Aluminum Base		
Black Mesh / Black Frame	SE3T-13-101	\$1060.00

Synchronized Tilt



SE3S

Dimensions

- *SH: 16.7"-20.9"
(424mm-531mm)
- H: 40.3"-44.5"
(1024mm-1130mm)
- D: 27.5"(699mm)
- W: 27.5"(699mm)
- *SW: 19.6"(498mm)
- *SD: 16.8"(427mm)
- *AH: 8.6"(218mm)

* Measurements taken with the BIFMA chair measuring device.

Features

- Back and Seat: One piece mesh construction.
- Base: Plastic or aluminum five-star base.
–Plastic base available in black or gray.
–Aluminum base available in Polished Aluminum.
- Arms: Fixed height arms.
- Mechanism: Synchronized tilt mechanism allows back and seat to adjust in tandem; standard with tilt tension adjustment.
- Back reclines 23.5° from upright position; standard with back lock.
- Frame: Available in Black or Gray Frame.
- Casters: Black frame will have solid hard casters in black. Gray frame will have open hard casters in gray.
- Mesh available in black, gray or light gray.
–Black mesh available with black frame only.
–Gray mesh available with black or gray frame.
–Light gray mesh available with gray frame only.
- COM/COL not available.
- **Ships KD and requires tool-less assembly.**

To Order, Specify:

- 1) Product number
- 2) Frame color.
TR-F Black
TR-GRY Gray
- 3) Base color.
Plastic - TR-F Black
TR-GRY Gray
Aluminum - PM-P Polished Aluminum

Note: Plastic base color must match frame color.

Description	Number	Price
Plastic Base		
Black Mesh / Black Frame	SE3S-13-105	\$1075.00
Gray Mesh / Black Frame	SE3S-29-105	1075.00
Gray Mesh / Gray Frame	SE3S-29-10H	\$1195.00
Light Gray Mesh / Gray Frame	SE3S-33-10H	1195.00
Aluminum Base		
Black Mesh / Black Frame	SE3S-13-101	\$1180.00
Gray Mesh / Black Frame	SE3S-29-101	1180.00
Gray Mesh / Gray Frame	SE3S-29-10G	\$1300.00
Light Gray Mesh / Gray Frame	SE3S-33-10G	1300.00

Veda

High-Back Chair

Synchronized Tilt



SE55

Dimensions

*SH: 16.7"-20.9"
(424mm-531mm)
H: 50.5"-54.7"
(1283mm-1389mm)
D: 27.5"(699mm)
W: 27.5"(699mm)
*SW: 19.6"(498mm)
*SD: 16.8"(427mm)
*AH: 8.6"(218mm)

* Measurements taken with the BIFMA chair measuring device.

Features

- Back and Seat: One piece mesh construction.
- Base: Plastic or aluminum five-star base.
 - Plastic base available in black or gray.
 - Aluminum base available in Polished Aluminum.
- Arms: Fixed height arms.
- Mechanism: Synchronized tilt mechanism allows back and seat to adjust in tandem; standard with tilt tension adjustment.
- Back reclines 23.5° from upright position; standard with back lock.
- Frame: Available in Black or Gray Frame.
- Casters: Black frame will have solid hard casters in black. Gray frame will have open hard casters in gray.
- Mesh available in black, gray or light gray.
 - Black mesh available with black frame only.
 - Gray mesh available with black or gray frame.
 - Light gray mesh available with gray frame only.
- COM/COL not available.
- **Ships KD and requires tool-less assembly.**

To Order, Specify:

- 1) Product number
- 2) Frame color.
 - TR-F Black
 - TR-GRY Gray
- 3) Base color.
 - Plastic - TR-F Black
 - TR-GRY Gray
 - Aluminum - PM-P Polished Aluminum

Note: Plastic base color must match frame color.

Description	Number	Price
Plastic Base		
Black Mesh / Black Frame	SE55-13-105	\$1200.00
Gray Mesh / Black Frame	SE55-29-105	1200.00
Gray Mesh / Gray Frame	SE55-29-10H	\$1320.00
Light Gray Mesh / Gray Frame	SE55-33-10H	1320.00
Aluminum Base		
Black Mesh / Black Frame	SE55-13-101	\$1305.00
Gray Mesh / Black Frame	SE55-29-101	1305.00
Gray Mesh / Gray Frame	SE55-29-10G	\$1425.00
Light Gray Mesh / Gray Frame	SE55-33-10G	1425.00

Zody II At-A-Glance

Designer	ITO Design and Haworth Design Studio
Awards/Achievements	<p>NeoCon Silver, Best of NeoCon, Seating: Ergonomic Desk/Task, June 2022, USA</p> <p>Metropolis Likes: Task Seating (winner) June 2022, USA</p> <p>Greenguard Gold</p> <p>Cradle to Cradle Certified Bronze</p>

Zody II A high-performing chair that blends science-based wellness and comfort with sustainability and international design.

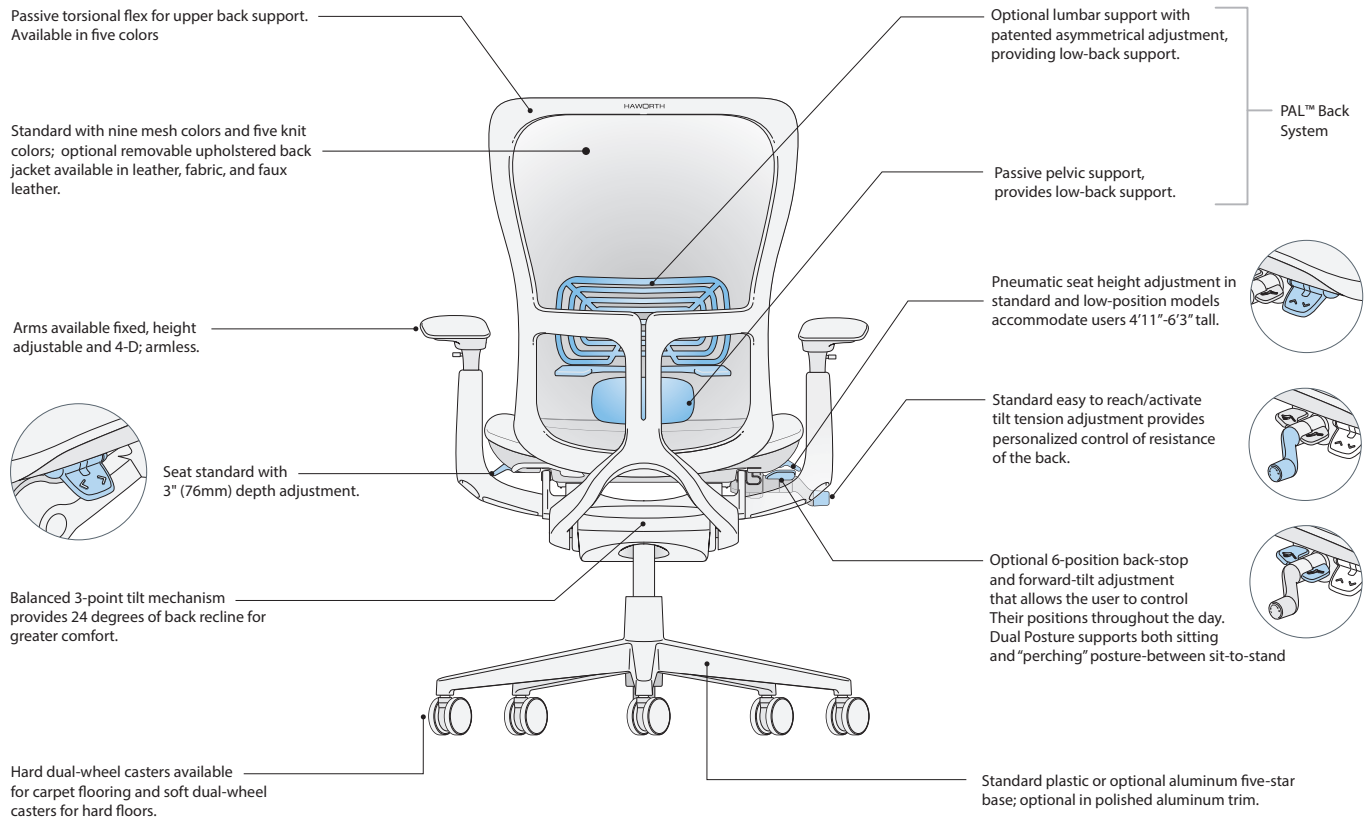

Note: Headrest and forward-tilt options available on task chair only.

Zody II At-A-Glance

General Guidelines for Product Specification

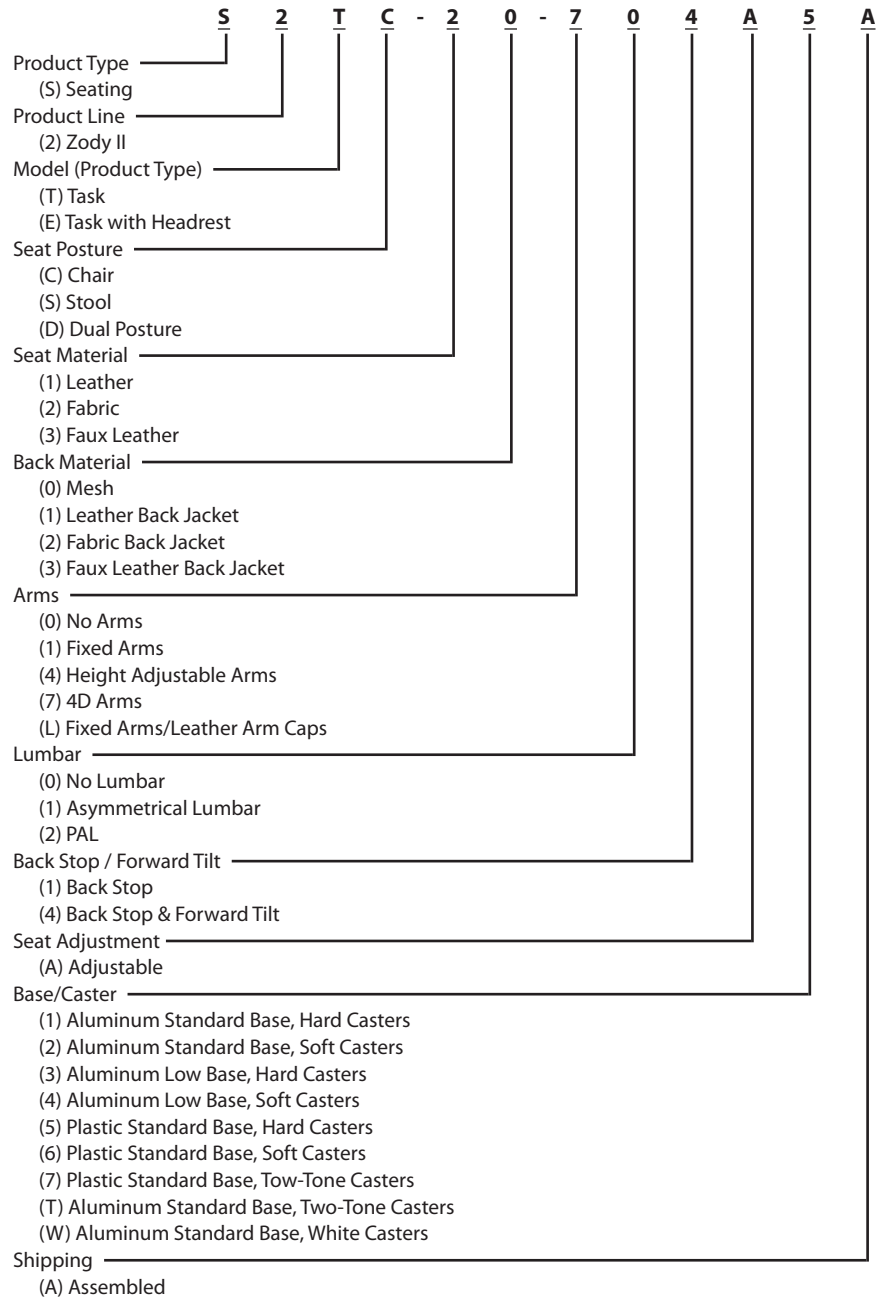

Zody II At-A-Glance

General Specifications

Environmental Factors	<ul style="list-style-type: none">• Zody II has been evaluated for its human health, environmental health, lifecycle attributes, renewable energy, water stewardship and social responsibility characteristics against stringent certification criteria and is considered an ecologically intelligent product.• Refer to Product Environmental Data sheet (PED) for recycled content and certifications.• Zody II is produced in an ISO 14001 certified manufacturing facility.• Components are identified with ISO recycling symbols and material information to assist in the recycling effort, where practical.• Haworth will take back Zody II chairs after their useful life and recycle the components. Please contact Haworth's Material Recovery Center at (616)393-1215.
COM & COL General Information	<p>To order a COM fabric (Customer's Own Material), contact the Haworth Inquiry Center (1.800.426.8562), your local Haworth dealer, or go to surfaces.haworth.com to find out if the COM you have selected has already been tested and approved. The surface collection site also has information on the Haworth alliance program with Carnegie, Luna Textiles, and Maharam as well as our industry-leading Pre-Approved COM program.</p> <p>COM fabrics are placed into Grades based on the cost per linear yard. If a fabric's cost exceeds the range of our highest Grade it will be noted as Non-Graded. The product will be priced at Grade A; the COM fabric costs will appear as a separate line item. The fabric charge will be Haworth's purchase cost plus a 4% administrative fee (based on the cost of the fabric). Yardage calculations will include any applicable fabric repeat.</p> <p>COM Leather products will be priced at a leather Grade A; COL costs will appear as a separate line item. The leather costs will be Haworth's purchase cost plus a 4% administrative fee (based on the cost of the leather).</p>
Finishes and Fabrics	For available finishes and fabrics please visit surfaces.haworth.com
Stain Repellent	<p>To specify add "P" to end of product number. Example: S2TC-20-714A5AP</p> <p>Not available on mesh, faux leather, or leather. For available fabrics, refer to surfaces.haworth.com.</p>
Shipping Weights (Including packaging)	<ul style="list-style-type: none">• Chairs with arms: 55 pounds/1 chair per carton/19.4 cubic feet• Chairs without arms: 49 pounds/1 chair per carton/19.4 cubic feet• Dual Posture with arms: 57.6 pounds/1 chair per carton/22.1 cubic feet• Dual Posture without arms: 51.6 pounds/1 chair per carton/22.1 cubic feet• Stool with arms: 58 pounds/1 stool per carton/22.1 cubic feet• Stool without arms: 52 pounds/1 stool per carton/22.1 cubic feet

Zody II

General Specifications

STANDARD MOBILITY AND ADJUSTABILITY

Balanced 3-point tilt



Features:

- Balanced 3-point tilt mechanism.
- Back reclines 24° from the upright position.
- Seat pan moves downward 3° from the initial position.

Benefits:

- Comfortable relaxed posture.
- Recline allows for the opening of the users' chest cavity providing good airflow to promote alertness.
- Users' feet remain flat.

Tilt Tension Control

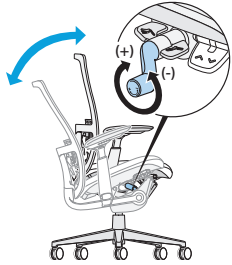

Feature:

- Easy-to-reach and easy-to-activate side-mounted tilt tension control regulates the amount of resistance felt when leaning back in the chair and the effort required to recline the chair backwards.

Benefit:

- Personalized support to accommodate users of different body types and different work styles.

Seat Height Adjustment

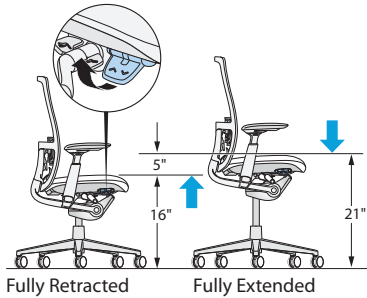

Features:

- Pneumatic seat height adjustment.
- Task chair seat height adjusts 5"(127mm) from 16" to 21"(406mm to 533mm) in standard models. Low-position adjusts 14.7" to 18"(373 to 457mm).
- Task stool seat height adjusts 7.3"(185mm) from 21" to 28.3"(533mm to 719mm).
- Dual Posture seat height adjusts 17.5" to 24.2"(445mm to 615mm).

Benefits:

- Ensures the comfort of the lower limbs by avoiding pressure on the underside of the thigh caused by a seat pan that is too high, or decreased thigh-to-torso angle if the seat pan is too low.
- Accommodates for users between approximately 4'11"(1499mm) and 6'3"(1905mm) tall to provide good leg circulation.
- Seat height adjustment also is important in setting the proper hand position and allowing for a proper sitting eye height.

Seat Depth Adjustment

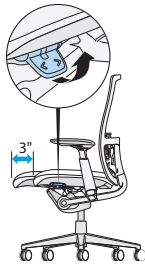

Features:

- 3"(76mm) of seat depth range.
- Waterfall edge.

Benefit:

- Supports the thighs, allows users to rest against the seat back for back support, and avoids pressure on the back of the knees of small to tall users.

Upper Back Torsional Movement



Feature:

- Passive 2"(51mm) of torsional flex in the upper back.
- Patented mesh with built in tension zones for added comfort.

Benefit:

- Increases users' mobility and comfort when reaching sideways for objects.

Zody II

General Specifications

OPTIONAL MOBILITY AND ADJUSTABILITY

PAL Back System

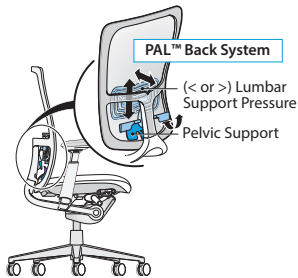

Features:

- PAL Back System includes Asymmetrical Lumbar Adjustment and passive pelvic support.
- Asymmetrical Lumbar Adjustment adjusts 4”(102mm) in height; support level can be adjusted independently for right or left-hand side of users’ body.
- Passive pelvic support.

Benefits:

- Lumbar adjustment maintains the natural curvature of the spine at the lower back and allows users to choose the support that feels right for them.
- Passive pelvic support rotates the pelvis forward to maintain the natural spine shape.

4D Arm

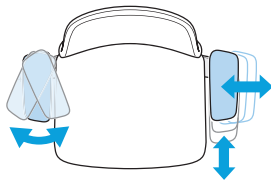

Features:

- Optional 4D arm.
- Arm adjusts in 4 ways:
 - Height adjustment: 4”(102mm)
 - Side-to-side arm cap adjustment range: 4”(102mm) [2”(51mm) each arm cap]
 - Front-to-back adjustment range: 2”(51mm)
 - Pivoting: In 20°; out 20°

Benefits:

- Arms support the muscular system of users’ neck and shoulders and proper arm support provides back relief. Arms can be an aid in standing or sitting down.
- Height adjustment accommodates for users with varying elbow rest heights so that users avoid lifting their shoulders or leaning sideways to get arm support.
- Front-to-back adjustment adjusts the armrest length, which is important because it allows users to get close to the worksurface while maintaining the effective use of the backrest.
- Side-to-side adjustment ensures a comfortable resting position for the arms with proper support of the forearm while allowing for easy entry/exit of the chair.
- Pivoting provides proper support of the forearm when performing tasks involving keying and mousing.

Adjustable Height Arm

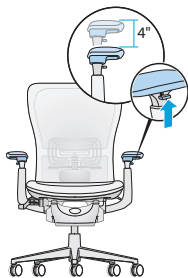

Feature:

- Optional height adjustable arms adjust 4”(102mm) vertically.

Benefit:

- Height adjustment accommodates users with varying elbow rest heights so that users avoid lifting their shoulders or leaning sideways to get arm support.

Back Stop

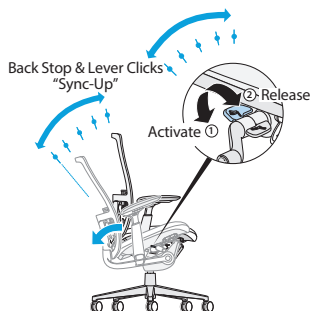

Features:

- Optional back stop;
- Back stops in 6 positions - upright and every 4° backward.

Benefit:

- Allows users the choice of selecting an upright position or limiting the amount of recline while performing different tasks.

Zody II

General Specifications

OPTIONAL MOBILITY AND ADJUSTABILITY (continued)

Back Stop/Forward Tilt

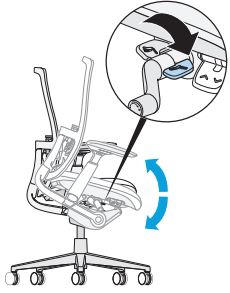
Feature:

- Optional back-stop and forward tilt.
- Back stops in 6 positions, upright and every 4° backward.
- Seat pan moves downward 5° from the initial position.

Benefits:

- Allows users to sit forward in the chair for task intensive work.
- Allows users to vary their posture for maximum comfort and for changes in task requirements.

Note: Not available on task stool.

Dual Posture

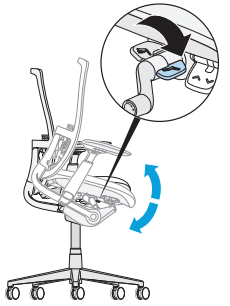
Features:

- Increased seat height range of 17.5"(445mm)-24.2"(615mm).
- Seat pan moves downward 5° from initial position with an increased degree of forward tilt.

Benefit:

- Promotes the in-between "perch" posture of sit-to-stand. Ideal for use with a height adjustable table.

Base

Standard Plastic Base

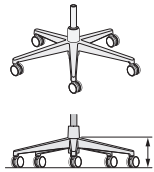

- TR-F Black
 TR-7 Fog

Note: When plastic base is specified all metal trim defaults to base color.

Hard casters in Black or Two-Tone Grey.
 Soft casters in Black.

Optional Aluminum Base

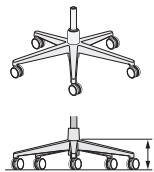

- TR-TF Pitch
 TR-LE Metallic Silver
 TR-MC Metallic Champagne
 TR-UFS Snowfall
 PM-P Polished Aluminum

Hard casters in Black, White or Two-Tone Grey.
 Soft casters in Black.

Low Position Base (Aluminum only)

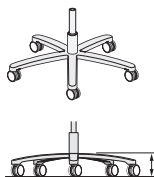

- TR-TF Pitch
 TR-LE Metallic Silver
 TR-MC Metallic Champagne
 TR-UFS Snowfall
 PM-P Polished Aluminum

Note: Low Position Base available on task chair only.

Hard or soft casters in Black.

Ergonomic Standards Guidelines

- All Zody II models meet or exceed all ANSI/BIFMA durability standards for office seating.
- Zody II meets the following ergonomic standards/guidelines:
 - BSR/HFES 100-2002
 - BIFMA G1-2002
 - CSA-Z412-2000
 - CAN/CGSB 44.232-2002
 - HFES 2007

Zody II

General Specifications
UPHOLSTERY / AESTHETIC OPTIONS

Leather Upholstery



Seat: Stitched double seams. Vertically in the center and on the edges of the seat cushion.

Back: Vertical stitched double seams on the upholstered back jacket with leather or Customers Own Leather (COL).

Upholstered Back Jacket

Front View:

Leather Jacket



Back View:



Features

- Removable.
- Back jacket covers the inside back of the chairs allowing a back view of the mesh. Jacket consists of padding covered with fabric or leather upholstery.
- Available in fabric, faux leather, leather, COM and COL.

Headrest



Features

- Height-adjustable 2.5" to fit a wide range of users, headrest is TPU material, like Zody II arm.
- Trim color of headrest front and back are in same color. Black or Fog only. If a trim color other than Black or Fog is specified, the headrest will default to Black or Fog based on the matrix below.
- Headrest sent not attached; 10.5"W x 7.5"H, 2.5" height adjustment.
- See Zody II price pages for specification (available on all task seating models). Not available on stools or Dual Posture.

Specification Example: S2EC-20-714A5A

To add a headrest to an existing model in the field order service part: Back and Headrest replacement, see e-Parts.

Specification

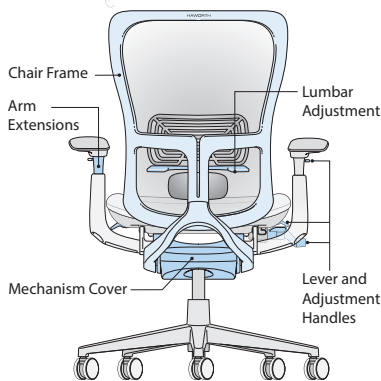

Features

- Trim color specification applies to the following components:
 - Chair frame
 - Levers
 - Adjustment handles
 - Lumbar adjustment (not lumbar pad)
 - Arm extensions
 - Mechanism covers
- Arm cap and Headrest color defaults based on the matrix below.

Trim Color	Arm Cap & Headrest Color*	
	Black	Fog
Black (TR-F)	•	
Fog (TR-7)		•
Snow (TR-UFM)		•

*Not specifiable.

Zody II

Task Chair



S2TC-20-0



S2TC-20-1



S2TC-20-4



S2TC-20-7

Dimensions*

- *SH: 16"-21"(406mm-533mm)
(Std. base)
14.7"-18"(373-457mm)
(Low base)
- H: 38"-43"(965mm-1092mm)
(Std. base)
36.7"-40"(932mm-1016mm)
(Low base)
- D: 29"(737mm)
- W: 29"(737mm)
- *SW: 19.5"(495mm)
- *SD: 16.8"-19.5"(427mm-495mm)
(with lumbar)
17.5"-20.2"(445mm-513mm)
(no lumbar)
- *AH: 7.6"-11.6"(193mm-295mm)
(Height Adjustable and 4D)
8.5"(216mm) (Fixed)

* Measurements taken with ISO chair measuring device.

Features

- Back: Knit, mesh, or mesh back with upholstered back jacket.
- Seat: Upholstered with 3"(76mm) adjustable seat depth range.
- Base options:
 - Plastic standard five-star base.
Casters: Hard casters in black or two-tone grey; Soft casters black only.
 - Aluminum standard five-star base.
Casters: Hard casters in black, white or two-tone grey; Soft casters black only.
 - Aluminum low-position five-star base.
Casters: Hard or soft casters in black only.
- Arm options:
 - No arms
 - Fixed arms; Optional leather arm caps available when leather seat is specified. Leather arm caps will match seat.
 - Height Adjustable; 4"(102mm) height adjustment range.
 - 4D; 4"(102mm) height adjustment, 4"(102mm) side-to-side range, 2"(51mm) front-to-back range and pivots 20° in and 20° out.
- Arm Cap will match plastic trim color (Black or Fog). When Snow is specified, arm cap will default to Fog.
- Height adjustment: Pneumatic or low-position pneumatic.
- Back Stop: Tilt stop in 6 positions.
- Back Stop/Forward Tilt; Tilt stop in 6 positions plus forward tilt 5° downward from initial position.
- Lumbar adjustment options:
 - No Lumbar
 - Asymmetrical Lumbar Adjustment: 4"(102mm) height adjustment; support level can be adjusted independently for right or left hand side of user's body.
 - PAL Back System: Asymmetrical lumbar adjustment with passive pelvic support.
- COM yardage / COL square footage:
Upholstered back jacket: 0.75/10
Seat: 0.75/10

NOTE: When specifying upholstered back jacket; must also specify mesh surface color for outside back.

Upcharge for mixed grade surfaces, refer to the electronic design and specification tools.

To Order, Specify:

- 1) Product number, including:

① Seat Material

- 1** Leather
- 2** Fabric
- 3** Faux Leather

② Base/Caster Option:

Plastic Base

- 5** Plastic Base, Hard Caster
- 6** Plastic Base, Soft Caster, add **\$52.08** list
- 7** Plastic Base, Two-Tone Grey Caster, add **\$20.00** list

Aluminum Base

- 1** Aluminum Base, Hard Caster, add **\$90.00** list
- 2** Aluminum Base, Soft Caster, add **\$142.08** list
- T** Aluminum Base, Two-Tone Grey Caster, add **\$110.00** list
- W** Aluminum Base, White Caster, add **\$110.00** list

Low Base - Aluminum

- 3** Aluminum Low Base, Hard Caster, add **\$90.00** list
- 4** Aluminum Low Base, Soft Caster, add **\$142.08** list

- 2) Seat upholstery.
- 3) Back upholstery (Mesh or Knit).
- 4) Back jacket surface and color (if applicable).
- 5) Plastic trim color.¹
TR-F Black
TR-7 Fog, add **\$90.00** list
TR-UFM Snow,² add **\$150.00** list
- 6) Aluminum trim color.³
TR-TF Pitch
TR-LE Metallic Silver
TR-MC Metallic Champagne
TR-UFS Snowfall
PM-P Polished Aluminum
- 7) Base trim color.
Plastic
TR-F Black
TR-7 Fog, add **\$20.00** list
Aluminum
TR-TF Pitch
TR-LE Metallic Silver
TR-MC Metallic Champagne
TR-UFS Snowfall, add **\$20.00** list
PM-P Polished Aluminum, add **\$290.00** list

¹ Plastic trim color for back frame, arm caps, seat pan cover.

² When TR-UFM Snow trim is specified, arm cap and head rest will default to TR-7 Fog.

³ Aluminum trim color for arm supports/uprights.

Zody II

Task Chair

Plastic Base* Adjustments	Arm	Number ①	②	Fabric Grade								Leather Grade A	Leather Grade B	
				A	B	C	D	E	F	G	H			
No Lumbar Adjustment - Mesh Back														
Back Stop	No arm	S2TC-	0-001A	A	\$ 980.00	\$1012.95	\$1048.07	\$1065.66	\$1078.83	\$1110.69	\$1139.22	\$1217.20	\$1464.60	\$1629.86
	Fixed	S2TC-	0-101A	A	1140.00	1172.95	1208.07	1225.66	1238.83	1270.69	1299.22	1377.20	1624.60	1789.86
	Height Adjustable	S2TC-	0-401A	A	1180.00	1212.95	1248.07	1265.66	1278.83	1310.69	1339.22	1417.20	1664.60	1829.86
	4D	S2TC-	0-701A	A	1214.00	1246.95	1282.07	1299.66	1312.83	1344.69	1373.22	1451.20	1698.60	1863.86
Back Stop/ Forward Tilt	No arm	S2TC-	0-004A	A	1086.00	1118.95	1154.07	1171.66	1184.83	1216.69	1245.22	1323.20	1570.60	1735.86
	Fixed	S2TC-	0-104A	A	1246.00	1278.95	1314.07	1331.66	1344.83	1376.69	1405.22	1483.20	1730.60	1895.86
	Height Adjustable	S2TC-	0-404A	A	1286.00	1318.95	1354.07	1371.66	1384.83	1416.69	1445.22	1523.20	1770.60	1935.86
	4D	S2TC-	0-704A	A	1320.00	1352.95	1388.07	1405.66	1418.83	1450.69	1479.22	1557.20	1804.60	1969.86
No Lumbar Adjustment - Knit Back														
Back Stop	No arm	S2TC-	0-001A	A	\$1112.00	\$1144.95	\$1180.07	\$1197.66	\$1210.83	\$1242.69	\$1271.22	\$1349.20	\$1596.60	\$1761.86
	Fixed	S2TC-	0-101A	A	1272.00	1304.95	1340.07	1357.66	1370.83	1402.69	1431.22	1509.20	1756.60	1921.86
	Height Adjustable	S2TC-	0-401A	A	1312.00	1344.95	1380.07	1397.66	1410.83	1442.69	1471.22	1549.20	1796.60	1961.86
	4D	S2TC-	0-701A	A	1346.00	1378.95	1414.07	1431.66	1444.83	1476.69	1505.22	1583.20	1830.60	1995.86
Back Stop/ Forward Tilt	No arm	S2TC-	0-004A	A	1218.00	1250.95	1286.07	1303.66	1316.83	1348.69	1377.22	1455.20	1702.60	1867.86
	Fixed	S2TC-	0-104A	A	1378.00	1410.95	1446.07	1463.66	1476.83	1508.69	1537.22	1615.20	1862.60	2027.86
	Height Adjustable	S2TC-	0-404A	A	1418.00	1450.95	1486.07	1503.66	1516.83	1548.69	1577.22	1655.20	1902.60	2067.86
	4D	S2TC-	0-704A	A	1452.00	1484.95	1520.07	1537.66	1550.83	1582.69	1611.22	1689.20	1936.60	2101.86
No Lumbar Adjustment - Back Jacket														
Back Stop	No arm	S2TC-	2-001A	A	\$1105.00	\$1170.43	\$1240.17	\$1275.09	\$1301.25	\$1364.52	\$1421.16	\$1576.01	\$2303.10	\$2704.08
	Fixed	S2TC-	2-101A	A	1265.00	1330.43	1400.17	1435.09	1461.25	1524.52	1581.16	1736.01	2463.10	2864.08
	Height Adjustable	S2TC-	2-401A	A	1305.00	1370.43	1440.17	1475.09	1501.25	1564.52	1621.16	1776.01	2503.10	2904.08
	4D	S2TC-	2-701A	A	1339.00	1404.43	1474.17	1509.09	1535.25	1598.52	1655.16	1810.01	2537.10	2938.08
Back Stop/ Forward Tilt	No arm	S2TC-	2-004A	A	1211.00	1276.43	1346.17	1381.09	1407.25	1470.52	1527.16	1682.01	2409.10	2810.08
	Fixed	S2TC-	2-104A	A	1371.00	1436.43	1506.17	1541.09	1567.25	1630.52	1687.16	1842.01	2569.10	2970.08
	Height Adjustable	S2TC-	2-404A	A	1411.00	1476.43	1546.17	1581.09	1607.25	1670.52	1727.16	1882.01	2609.10	3010.08
	4D	S2TC-	2-704A	A	1445.00	1510.43	1580.17	1615.09	1641.25	1704.52	1761.16	1916.01	2643.10	3044.08
Asymmetrical Lumbar Adjustment - Mesh Back														
Back Stop	No arm	S2TC-	0-011A	A	\$1077.00	\$1109.95	\$1145.07	\$1162.66	\$1175.83	\$1207.69	\$1236.22	\$1314.20	\$1561.60	\$1726.86
	Fixed	S2TC-	0-111A	A	1237.00	1269.95	1305.07	1322.66	1335.83	1367.69	1396.22	1474.20	1721.60	1886.86
	Height Adjustable	S2TC-	0-411A	A	1277.00	1309.95	1345.07	1362.66	1375.83	1407.69	1436.22	1514.20	1761.60	1926.86
	4D	S2TC-	0-711A	A	1311.00	1343.95	1379.07	1396.66	1409.83	1441.69	1470.22	1548.20	1795.60	1960.86
Back Stop/ Forward Tilt	No arm	S2TC-	0-014A	A	1183.00	1215.95	1251.07	1268.66	1281.83	1313.69	1342.22	1420.20	1667.60	1832.86
	Fixed	S2TC-	0-114A	A	1343.00	1375.95	1411.07	1428.66	1441.83	1473.69	1502.22	1580.20	1827.60	1992.86
	Height Adjustable	S2TC-	0-414A	A	1383.00	1415.95	1451.07	1468.66	1481.83	1513.69	1542.22	1620.20	1867.60	2032.86
	4D	S2TC-	0-714A	A	1417.00	1449.95	1485.07	1502.66	1515.83	1547.69	1576.22	1654.20	1901.60	2066.86
Asymmetrical Lumbar Adjustment - Knit Back														
Back Stop	No arm	S2TC-	0-011A	A	\$1209.00	\$1241.95	\$1277.07	\$1294.66	\$1307.83	\$1339.69	\$1368.22	\$1446.20	\$1693.60	\$1858.86
	Fixed	S2TC-	0-111A	A	1369.00	1401.95	1437.07	1454.66	1467.83	1499.69	1528.22	1606.20	1853.60	2018.86
	Height Adjustable	S2TC-	0-411A	A	1409.00	1441.95	1477.07	1494.66	1507.83	1539.69	1568.22	1646.20	1893.60	2058.86
	4D	S2TC-	0-711A	A	1443.00	1475.95	1511.07	1528.66	1541.83	1573.69	1602.22	1680.20	1927.60	2092.86
Back Stop/ Forward Tilt	No arm	S2TC-	0-014A	A	1315.00	1347.95	1383.07	1400.66	1413.83	1445.69	1474.22	1552.20	1799.60	1964.86
	Fixed	S2TC-	0-114A	A	1475.00	1507.95	1543.07	1560.66	1573.83	1605.69	1634.22	1712.20	1959.60	2124.86
	Height Adjustable	S2TC-	0-414A	A	1515.00	1547.95	1583.07	1600.66	1613.83	1645.69	1674.22	1752.20	1999.60	2164.86
	4D	S2TC-	0-714A	A	1549.00	1581.95	1617.07	1634.66	1647.83	1679.69	1708.22	1786.20	2033.60	2198.86

* Pricing based on Plastic base with hard casters.

Zody II

Task Chair

Plastic Base* Adjustments	Arm	Number		Fabric Grade								Leather Grade A	Leather Grade B	
		①	②	A	B	C	D	E	F	G	H			
Asymmetrical Lumbar Adjustment - Back Jacket														
Back Stop	No arm	S2TC-	2-011A	A	\$1202.00	\$1267.43	\$1337.17	\$1372.09	\$1398.25	\$1461.52	\$1518.16	\$1673.01	\$2400.10	\$2801.08
	Fixed	S2TC-	2-111A	A	1362.00	1427.43	1497.17	1532.09	1558.25	1621.52	1678.16	1833.01	2560.10	2961.08
	Height Adjustable	S2TC-	2-411A	A	1402.00	1467.43	1537.17	1572.09	1598.25	1661.52	1718.16	1873.01	2600.10	3001.08
	4D	S2TC-	2-711A	A	1436.00	1501.43	1571.17	1606.09	1632.25	1695.52	1752.16	1907.01	2634.10	3035.08
Back Stop/ Forward Tilt	No arm	S2TC-	2-014A	A	1308.00	1373.43	1443.17	1478.09	1504.25	1567.52	1624.16	1779.01	2506.10	2907.08
	Fixed	S2TC-	2-114A	A	1468.00	1533.43	1603.17	1638.09	1664.25	1727.52	1784.16	1939.01	2666.10	3067.08
	Height Adjustable	S2TC-	2-414A	A	1508.00	1573.43	1643.17	1678.09	1704.25	1767.52	1824.16	1979.01	2706.10	3107.08
	4D	S2TC-	2-714A	A	1542.00	1607.43	1677.17	1712.09	1738.25	1801.52	1858.16	2013.01	2740.10	3141.08
PAL Back System - Mesh Back														
Back Stop	No arm	S2TC-	0-021A	A	\$1106.00	\$1138.95	\$1174.07	\$1191.66	\$1204.83	\$1236.69	\$1265.22	\$1343.20	\$1590.60	\$1755.86
	Fixed	S2TC-	0-121A	A	1266.00	1298.95	1334.07	1351.66	1364.83	1396.69	1425.22	1503.20	1750.60	1915.86
	Height Adjustable	S2TC-	0-421A	A	1306.00	1338.95	1374.07	1391.66	1404.83	1436.69	1465.22	1543.20	1790.60	1955.86
	4D	S2TC-	0-721A	A	1340.00	1372.95	1408.07	1425.66	1438.83	1470.69	1499.22	1577.20	1824.60	1989.86
Back Stop/ Forward Tilt	No arm	S2TC-	0-024A	A	1212.00	1244.95	1280.07	1297.66	1310.83	1342.69	1371.22	1449.20	1696.60	1861.86
	Fixed	S2TC-	0-124A	A	1372.00	1404.95	1440.07	1457.66	1470.83	1502.69	1531.22	1609.20	1856.60	2021.86
	Height Adjustable	S2TC-	0-424A	A	1412.00	1444.95	1480.07	1497.66	1510.83	1542.69	1571.22	1649.20	1896.60	2061.86
	4D	S2TC-	0-724A	A	1446.00	1478.95	1514.07	1531.66	1544.83	1576.69	1605.22	1683.20	1930.60	2095.86
PAL Back System - Knit Back														
Back Stop	No arm	S2TC-	0-021A	A	\$1238.00	\$1270.95	\$1306.07	\$1323.66	\$1336.83	\$1368.69	\$1397.22	\$1475.20	\$1722.60	\$1887.86
	Fixed	S2TC-	0-121A	A	1398.00	1430.95	1466.07	1483.66	1496.83	1528.69	1557.22	1635.20	1882.60	2047.86
	Height Adjustable	S2TC-	0-421A	A	1438.00	1470.95	1506.07	1523.66	1536.83	1568.69	1597.22	1675.20	1922.60	2087.86
	4D	S2TC-	0-721A	A	1472.00	1504.95	1540.07	1557.66	1570.83	1602.69	1631.22	1709.20	1956.60	2121.86
Back Stop/ Forward Tilt	No arm	S2TC-	0-024A	A	1344.00	1376.95	1412.07	1429.66	1442.83	1474.69	1503.22	1581.20	1828.60	1993.86
	Fixed	S2TC-	0-124A	A	1504.00	1536.95	1572.07	1589.66	1602.83	1634.69	1663.22	1741.20	1988.60	2153.86
	Height Adjustable	S2TC-	0-424A	A	1544.00	1576.95	1612.07	1629.66	1642.83	1674.69	1703.22	1781.20	2028.60	2193.86
	4D	S2TC-	0-724A	A	1578.00	1610.95	1646.07	1663.66	1676.83	1708.69	1737.22	1815.20	2062.60	2227.86
PAL Back System - Back Jacket														
Back Stop	No arm	S2TC-	2-021A	A	\$1231.00	\$1296.43	\$1366.17	\$1401.09	\$1427.25	\$1490.52	\$1547.16	\$1702.01	\$2429.10	\$2830.08
	Fixed	S2TC-	2-121A	A	1391.00	1456.43	1526.17	1561.09	1587.25	1650.52	1707.16	1862.01	2589.10	2990.08
	Height Adjustable	S2TC-	2-421A	A	1431.00	1496.43	1566.17	1601.09	1627.25	1690.52	1747.16	1902.01	2629.10	3030.08
	4D	S2TC-	2-721A	A	1465.00	1530.43	1600.17	1635.09	1661.25	1724.52	1781.16	1936.01	2663.10	3064.08
Back Stop/ Forward Tilt	No arm	S2TC-	2-024A	A	1337.00	1402.43	1472.17	1507.09	1533.25	1596.52	1653.16	1808.01	2535.10	2936.08
	Fixed	S2TC-	2-124A	A	1497.00	1562.43	1632.17	1667.09	1693.25	1756.52	1813.16	1968.01	2695.10	3096.08
	Height Adjustable	S2TC-	2-424A	A	1537.00	1602.43	1672.17	1707.09	1733.25	1796.52	1853.16	2008.01	2735.10	3136.08
	4D	S2TC-	2-724A	A	1571.00	1636.43	1706.17	1741.09	1767.25	1830.52	1887.16	2042.01	2769.10	3170.08

* Pricing based on Plastic base with hard casters.

The following options require modification of the product number.

- Headrest
- Leather Arm Caps (Fixed arm only)
- Leather Seat and Back Jacket
- Faux Leather Seat and Back Jacket
- Stain Repellent

To specify, change the 3rd digit to an **E**; **Example:** S2EC-20-714A5A (add \$65 list)
 To specify, change the 7th digit to an **L**; **Example:** S2TC-10-L14A5A (add \$260.00 list)
Note: Leather arm caps available only when leather seat is specified. Arm cap will match seat.
 To Specify, change the 6th digit to a **1**; **Example:** S2TC-11-714A5A
 To Specify, change the 6th digit to a **3**; **Example:** S2TC-33-714A5A
 To specify, add **P** to end of the product number; **Example:** S2TC-20-714A5AP (add \$35.00 list)

Zody II

Stool



S2TS-20-0



S2TS-20-1



S2TS-20-4



S2TS-20-7

Dimensions*

- *SH: 21"-28.3"(533mm-719mm)
- H: 43"-50.3"(1092mm-1278mm)
- D: 29"(737mm)
- W: 29"(737mm)
- *SW: 19.5"(495mm)
- *SD: 16.8"-19.5"(427mm-495mm) (with lumbar)
- 17.5"-20.2"(445mm-513mm) (no lumbar)
- *AH: 7.6"-11.6"(193mm-295mm) (Height Adjustable and 4D)
- 8.5"(216mm) (Fixed)

* Measurements taken with ISO chair measuring device.

Features

- Back: Knit, mesh, or mesh back with upholstered back jacket.
- Seat: Upholstered with 3"(76mm) adjustable seat depth range.
- Base options:
 - Plastic standard five-star base. Casters: Hard casters in black or two-tone grey; Soft casters black only.
 - Aluminum standard five-star base. Casters: Hard casters in black, white or two-tone grey; Soft casters black only.
- Arm options:
 - No arms
 - Fixed arms; Optional leather arm caps available when leather seat is specified. Leather arm caps will match seat.
 - Height Adjustable; 4"(102mm) height adjustment range.
 - 4D; 4"(102mm) height adjustment, 4"(102mm) side-to-side range, 2"(51mm) front-to-back range and pivots 20° in and 20° out.
- Arm Cap will match plastic trim color (Black or Fog). When Snow is specified, arm cap will default to Fog.
- Height adjustment: Pneumatic.
- Back Stop: Tilt stop in 6 positions.
- Lumbar adjustment options:
 - No Lumbar
 - Asymmetrical Lumbar Adjustment: 4"(102mm) height adjustment; support level can be adjusted independently for right or left hand side of user's body.
 - PAL Back System: Asymmetrical lumbar adjustment with passive pelvic support.
- COM yardage / COL square footage: Upholstered back jacket: 0.75/10
Seat: 0.75/10

NOTE: When specifying upholstered back jacket; must also specify mesh surface color for outside back.

Upcharge for mixed grade surfaces, refer to the electronic design and specification tools.

To Order, Specify:

1) Product number, including:

1 Seat Material

- 1 Leather
- 2 Fabric
- 3 Faux Leather

2 Base/Caster Option:

Plastic Base

- 5 Plastic Base, Hard Caster
- 6 Plastic Base, Soft Caster, add **\$52.08** list
- 7 Plastic Base, Two-Tone Grey Caster, add **\$20.00** list

Aluminum Base

- 1 Aluminum Base, Hard Caster, add **\$90.00** list
- 2 Aluminum Base, Soft Caster, add **\$142.08** list
- T Aluminum Base, Two-Tone Grey Caster, add **\$110.00** list
- W Aluminum Base, White Caster, add **\$110.00** list

- 2) Seat upholstery.
- 3) Back upholstery (Mesh or Knit).
- 4) Plastic trim color.¹
 - TR-F Black
 - TR-7 Fog, add **\$90.00** list
 - TR-UFM Snow,² add **\$150.00** list
- 5) Aluminum trim color.³
 - TR-TF Pitch
 - TR-LE Metallic Silver
 - TR-MC Metallic Champagne
 - TR-UFS Snowfall
 - PM-P Polished Aluminum
- 6) Base trim color.
 - Plastic
 - TR-F Black
 - TR-7 Fog, add **\$20.00** list
 - Aluminum
 - TR-TF Pitch
 - TR-LE Metallic Silver
 - TR-MC Metallic Champagne
 - TR-UFS Snowfall, add **\$20.00** list
 - PM-P Polished Aluminum, add **\$290.00** list

¹ Plastic trim color for back frame, arm caps, seat pan cover.

² When TR-UFM Snow trim is specified, arm cap will default to TR-7 Fog.

³ Aluminum trim color for arm supports/uprights.

Zody II

Stool

Plastic Base* Adjustments	Arm	Number		Fabric Grade								Leather Grade A	Leather Grade B	
		①	②	A	B	C	D	E	F	G	H			
No Lumbar Adjustment - Mesh Back														
Back Stop	No arm	S2TS-	0-001A	A	\$1237.00	\$1269.95	\$1305.07	\$1322.66	\$1335.83	\$1367.69	\$1396.22	\$1474.20	\$1721.60	\$1886.86
	Fixed	S2TS-	0-101A	A	1397.00	1429.95	1465.07	1482.66	1495.83	1527.69	1556.22	1634.20	1881.60	2046.86
	Height Adjustable	S2TS-	0-401A	A	1437.00	1469.95	1505.07	1522.66	1535.83	1567.69	1596.22	1674.20	1921.60	2086.86
	4D	S2TS-	0-701A	A	1471.00	1503.95	1539.07	1556.66	1569.83	1601.69	1630.22	1708.20	1955.60	2120.86
No Lumbar Adjustment - Knit Back														
Back Stop	No arm	S2TS-	0-001A	A	\$1369.00	\$1401.95	\$1437.07	\$1454.66	\$1467.83	\$1499.69	\$1528.22	\$1606.20	\$1853.60	\$2018.86
	Fixed	S2TS-	0-101A	A	1529.00	1561.95	1597.07	1614.66	1627.83	1659.69	1688.22	1766.20	2013.60	2178.86
	Height Adjustable	S2TS-	0-401A	A	1569.00	1601.95	1637.07	1654.66	1667.83	1699.69	1728.22	1806.20	2053.60	2218.86
	4D	S2TS-	0-701A	A	1603.00	1635.95	1671.07	1688.66	1701.83	1733.69	1762.22	1840.20	2087.60	2252.86
No Lumbar Adjustment - Back Jacket														
Back Stop	No arm	S2TS-	2-001A	A	\$1362.00	\$1427.43	\$1497.17	\$1532.09	\$1558.25	\$1621.52	\$1678.16	\$1833.01	\$2560.10	\$2961.08
	Fixed	S2TS-	2-101A	A	1522.00	1587.43	1657.17	1692.09	1718.25	1781.52	1838.16	1993.01	2720.10	3121.08
	Height Adjustable	S2TS-	2-401A	A	1562.00	1627.43	1697.17	1732.09	1758.25	1821.52	1878.16	2033.01	2760.10	3161.08
	4D	S2TS-	2-701A	A	1596.00	1661.43	1731.17	1766.09	1792.25	1855.52	1912.16	2067.01	2794.10	3195.08
Asymmetrical Lumbar Adjustment - Mesh Back														
Back Stop	No arm	S2TS-	0-011A	A	\$1334.00	\$1366.95	\$1402.07	\$1419.66	\$1432.83	\$1464.69	\$1493.22	\$1571.20	\$1818.60	\$1983.86
	Fixed	S2TS-	0-111A	A	1494.00	1526.95	1562.07	1579.66	1592.83	1624.69	1653.22	1731.20	1978.60	2143.86
	Height Adjustable	S2TS-	0-411A	A	1534.00	1566.95	1602.07	1619.66	1632.83	1664.69	1693.22	1771.20	2018.60	2183.86
	4D	S2TS-	0-711A	A	1568.00	1600.95	1636.07	1653.66	1666.83	1698.69	1727.22	1805.20	2052.60	2217.86
Asymmetrical Lumbar Adjustment - Knit Back														
Back Stop	No arm	S2TS-	0-011A	A	\$1466.00	\$1498.95	\$1534.07	\$1551.66	\$1564.83	\$1596.69	\$1625.22	\$1703.20	\$1950.60	\$2115.86
	Fixed	S2TS-	0-111A	A	1626.00	1658.95	1694.07	1711.66	1724.83	1756.69	1785.22	1863.20	2110.60	2275.86
	Height Adjustable	S2TS-	0-411A	A	1666.00	1698.95	1734.07	1751.66	1764.83	1796.69	1825.22	1903.20	2150.60	2315.86
	4D	S2TS-	0-711A	A	1700.00	1732.95	1768.07	1785.66	1798.83	1830.69	1859.22	1937.20	2184.60	2349.86
Asymmetrical Lumbar Adjustment - Back Jacket														
Back Stop	No arm	S2TS-	2-011A	A	\$1459.00	\$1524.43	\$1594.17	\$1629.09	\$1655.25	\$1718.52	\$1775.16	\$1930.01	\$2657.10	\$3058.08
	Fixed	S2TS-	2-111A	A	1619.00	1684.43	1754.17	1789.09	1815.25	1878.52	1935.16	2090.01	2817.10	3218.08
	Height Adjustable	S2TS-	2-411A	A	1659.00	1724.43	1794.17	1829.09	1855.25	1918.52	1975.16	2130.01	2857.10	3258.08
	4D	S2TS-	2-711A	A	1693.00	1758.43	1828.17	1863.09	1889.25	1952.52	2009.16	2164.01	2891.10	3292.08
PAL Back System - Mesh Back														
Back Stop	No arm	S2TS-	0-021A	A	\$1363.00	\$1395.95	\$1431.07	\$1448.66	\$1461.83	\$1493.69	\$1522.22	\$1600.20	\$1847.60	\$2012.86
	Fixed	S2TS-	0-121A	A	1523.00	1555.95	1591.07	1608.66	1621.83	1653.69	1682.22	1760.20	2007.60	2172.86
	Height Adjustable	S2TS-	0-421A	A	1563.00	1595.95	1631.07	1648.66	1661.83	1693.69	1722.22	1800.20	2047.60	2212.86
	4D	S2TS-	0-721A	A	1597.00	1629.95	1665.07	1682.66	1695.83	1727.69	1756.22	1834.20	2081.60	2246.86
PAL Back System - Knit Back														
Back Stop	No arm	S2TS-	0-021A	A	\$1495.00	\$1527.95	\$1563.07	\$1580.66	\$1593.83	\$1625.69	\$1654.22	\$1732.20	\$1979.60	\$2144.86
	Fixed	S2TS-	0-121A	A	1655.00	1687.95	1723.07	1740.66	1753.83	1785.69	1814.22	1892.20	2139.60	2304.86
	Height Adjustable	S2TS-	0-421A	A	1695.00	1727.95	1763.07	1780.66	1793.83	1825.69	1854.22	1932.20	2179.60	2344.86
	4D	S2TS-	0-721A	A	1729.00	1761.95	1797.07	1814.66	1827.83	1859.69	1888.22	1966.20	2213.60	2378.86
PAL Back System - Back Jacket														
Back Stop	No arm	S2TS-	2-021A	A	\$1488.00	\$1553.43	\$1623.17	\$1658.09	\$1684.25	\$1747.52	\$1804.16	\$1959.01	\$2686.10	\$3087.08
	Fixed	S2TS-	2-121A	A	1648.00	1713.43	1783.17	1818.09	1844.25	1907.52	1964.16	2119.01	2846.10	3247.08
	Height Adjustable	S2TS-	2-421A	A	1688.00	1753.43	1823.17	1858.09	1884.25	1947.52	2004.16	2159.01	2886.10	3287.08
	4D	S2TS-	2-721A	A	1722.00	1787.43	1857.17	1892.09	1918.25	1981.52	2038.16	2193.01	2920.10	3321.08

* Pricing based on Plastic base with hard casters.

The following options require modification of the product number.

Leather Arm Caps (Fixed arm only)

Leather Seat and Back Jacket
 Faux Leather Seat and Back Jacket
 Stain Repellent

To specify, change the 7th digit to an **L**; **Example:** S2TS-10-L14A5A (add **\$260.00** list)
Note: Leather arm caps available only when leather seat is specified. Arm cap will match seat.
 To Specify, change the 6th digit to a **1**; **Example:** S2TS-11-714A5A
 To Specify, change the 6th digit to a **3**; **Example:** S2TS-33-714A5A
 To specify, add **P** to end of the product number; **Example:** S2TS-20-714A5AP (add **\$35.00** list)

Zody II

Dual Posture



S2TD-20-1



S2TD-20-4



S2TD-20-7

Dimensions*

- *SH: 17.5"-24.2"(445mm-615mm)
- H: 39.5"-46.2"(1003mm-1173mm)
- D: 29"(737mm)
- W: 29"(737mm)
- *SW: 19.5"(495mm)
- *SD: 16.8"-19.5"(427mm-495mm) (with lumbar)
- 17.5"-20.2"(445mm-513mm) (no lumbar)
- *AH: 7.6"-11.6"(193mm-295mm) (Height Adjustable and 4D)
- 8.5"(216mm) (Fixed)

* Measurements taken with ISO chair measuring device.

Features

- Back: Knit, mesh, or mesh back with upholstered back jacket.
- Seat: Upholstered with 3"(76mm) adjustable seat depth range.
- Base options:
 - Aluminum standard five-star base.
 - Casters: Hard casters in black, white or two-tone grey; Soft casters black only.
- Arm options:
 - Fixed arms; Optional leather arm caps available when leather seat is specified. Leather arm caps will match seat.
 - Height Adjustable; 4"(102mm) height adjustment range.
 - 4D; 4"(102mm) height adjustment, 4"(102mm) side-to-side range, 2"(51mm) front-to-back range and pivots 20° in and 20° out.
- Arm Cap will match plastic trim color (Black or Fog). When Snow is specified, arm cap will default to Fog.
- Height adjustment: Pneumatic.
- Back Stop/Forward Tilt; Tilt stop in 6 positions plus forward tilt 5° downward from initial position.
- Lumbar adjustment options:
 - No Lumbar
 - Asymmetrical Lumbar Adjustment: 4"(102mm) height adjustment; support level can be adjusted independently for right or left hand side of user's body.
 - PAL Back System: Asymmetrical lumbar adjustment with passive pelvic support.
- COM yardage / COL square footage: Upholstered back jacket: 0.75/10
Seat: 0.75/10

NOTE: When specifying upholstered back jacket; must also specify mesh surface color for outside back.

Upcharge for mixed grade surfaces, refer to the electronic design and specification tools.

To Order, Specify:

1) Product number, including:

1 Seat Material

- 1 Leather
- 2 Fabric
- 3 Faux Leather

2 Base/Caster Option:

Aluminum Base

- 1 Aluminum Base, Hard Caster
- 2 Aluminum Base, Soft Caster, add **\$52.08** list
- T Aluminum Base, Two-Tone Grey Caster, add **\$20.00** list
- W Aluminum Base, White Caster, add **\$20.00** list

- 2) Seat upholstery.
- 3) Back upholstery (Mesh or Knit).
- 4) Plastic trim color.¹
 - TR-F Black
 - TR-7 Fog, add **\$90.00** list
 - TR-UFM Snow,² add **\$150.00** list
- 5) Aluminum trim color.³
 - TR-TF Pitch
 - TR-LE Metallic Silver
 - TR-MC Metallic Champagne
 - TR-UFS Snowfall
 - PM-P Polished Aluminum
- 6) Base trim color.
 - TR-TF Pitch
 - TR-LE Metallic Silver
 - TR-MC Metallic Champagne
 - TR-UFS Snowfall, add **\$20.00** list
 - PM-P Polished Aluminum, add **\$290.00** list

¹ Plastic trim color for back frame, arm caps, seat pan cover.

² When TR-UFM Snow trim is specified, arm cap will default to TR-7 Fog.

³ Aluminum trim color for arm supports/uprights.

Zody II

Dual Posture

Adjustments	Arm	Number		Fabric Grade								Leather Grade A	Leather Grade B	
		①	②	A	B	C	D	E	F	G	H			
No Lumbar Adjustment - Mesh Back														
Back Stop/ Forward Tilt	Fixed	S2TD-	0-104A	A	\$1536.00	\$1568.95	\$1604.07	\$1621.66	\$1634.83	\$1666.69	\$1695.22	\$1773.20	\$2020.60	\$2185.86
	Height Adjustable	S2TD-	0-404A	A	1576.00	1608.95	1644.07	1661.66	1674.83	1706.69	1735.22	1813.20	2060.60	2225.86
	4D	S2TD-	0-704A	A	1610.00	1642.95	1678.07	1695.66	1708.83	1740.69	1769.22	1847.20	2094.60	2259.86
No Lumbar Adjustment - Knit Back														
Back Stop/ Forward Tilt	Fixed	S2TD-	0-104A	A	\$1668.00	\$1700.95	\$1736.07	\$1753.66	\$1766.83	\$1798.69	\$1827.22	\$1905.20	\$2152.60	\$2317.86
	Height Adjustable	S2TD-	0-404A	A	1708.00	1740.95	1776.07	1793.66	1806.83	1838.69	1867.22	1945.20	2192.60	2357.86
	4D	S2TD-	0-704A	A	1742.00	1774.95	1810.07	1827.66	1840.83	1872.69	1901.22	1979.20	2226.60	2391.86
No Lumbar Adjustment - Back Jacket														
Back Stop/ Forward Tilt	Fixed	S2TD-	2-104A	A	\$1661.00	\$1726.43	\$1796.17	\$1831.09	\$1857.25	\$1920.52	\$1977.16	\$2132.01	\$2859.10	\$3260.08
	Height Adjustable	S2TD-	2-404A	A	1701.00	1766.43	1836.17	1871.09	1897.25	1960.52	2017.16	2172.01	2899.10	3300.08
	4D	S2TD-	2-704A	A	1735.00	1800.43	1870.17	1905.09	1931.25	1994.52	2051.16	2206.01	2933.10	3334.08
Asymmetrical Lumbar Adjustment - Mesh Back														
Back Stop/ Forward Tilt	Fixed	S2TD-	0-114A	A	\$1633.00	\$1665.95	\$1701.07	\$1718.66	\$1731.83	\$1763.69	\$1792.22	\$1870.20	\$2117.60	\$2282.86
	Height Adjustable	S2TD-	0-414A	A	1673.00	1705.95	1741.07	1758.66	1771.83	1803.69	1832.22	1910.20	2157.60	2322.86
	4D	S2TD-	0-714A	A	1707.00	1739.95	1775.07	1792.66	1805.83	1837.69	1866.22	1944.20	2191.60	2356.86
Asymmetrical Lumbar Adjustment - Knit Back														
Back Stop/ Forward Tilt	Fixed	S2TD-	0-114A	A	\$1765.00	\$1797.95	\$1833.07	\$1850.66	\$1863.83	\$1895.69	\$1924.22	\$2002.20	\$2249.60	\$2414.86
	Height Adjustable	S2TD-	0-414A	A	1805.00	1837.95	1873.07	1890.66	1903.83	1935.69	1964.22	2042.20	2289.60	2454.86
	4D	S2TD-	0-714A	A	1839.00	1871.95	1907.07	1924.66	1937.83	1969.69	1998.22	2076.20	2323.60	2488.86
Asymmetrical Lumbar Adjustment - Back Jacket														
Back Stop/ Forward Tilt	Fixed	S2TD-	2-114A	A	\$1758.00	\$1823.43	\$1893.17	\$1928.09	\$1954.25	\$2017.52	\$2074.16	\$2229.01	\$2956.10	\$3357.08
	Height Adjustable	S2TD-	2-414A	A	1798.00	1863.43	1933.17	1968.09	1994.25	2057.52	2114.16	2269.01	2996.10	3397.08
	4D	S2TD-	2-714A	A	1832.00	1897.43	1967.17	2002.09	2028.25	2091.52	2148.16	2303.01	3030.10	3431.08
PAL Back System - Mesh Back														
Back Stop/ Forward Tilt	Fixed	S2TD-	0-124A	A	\$1662.00	\$1694.95	\$1730.07	\$1747.66	\$1760.83	\$1792.69	\$1821.22	\$1899.20	\$2146.60	\$2311.86
	Height Adjustable	S2TD-	0-424A	A	1702.00	1734.95	1770.07	1787.66	1800.83	1832.69	1861.22	1939.20	2186.60	2351.86
	4D	S2TD-	0-724A	A	1736.00	1768.95	1804.07	1821.66	1834.83	1866.69	1895.22	1973.20	2220.60	2385.86
PAL Back System - Knit Back														
Back Stop/ Forward Tilt	Fixed	S2TD-	0-124A	A	\$1794.00	\$1826.95	\$1862.07	\$1879.66	\$1892.83	\$1924.69	\$1953.22	\$2031.20	\$2278.60	\$2443.86
	Height Adjustable	S2TD-	0-424A	A	1834.00	1866.95	1902.07	1919.66	1932.83	1964.69	1993.22	2071.20	2318.60	2483.86
	4D	S2TD-	0-724A	A	1868.00	1900.95	1936.07	1953.66	1966.83	1998.69	2027.22	2105.20	2352.60	2517.86
PAL Back System - Back Jacket														
Back Stop/ Forward Tilt	Fixed	S2TD-	2-124A	A	\$1787.00	\$1852.43	\$1922.17	\$1957.09	\$1983.25	\$2046.52	\$2103.16	\$2258.01	\$2985.10	\$3386.08
	Height Adjustable	S2TD-	2-424A	A	1827.00	1892.43	1962.17	1997.09	2023.25	2086.52	2143.16	2298.01	3025.10	3426.08
	4D	S2TD-	2-724A	A	1861.00	1926.43	1996.17	2031.09	2057.25	2120.52	2177.16	2332.01	3059.10	3460.08

The following options require modification of the product number.

Leather Arm Caps (Fixed arm only)

To specify, change the 7th digit to an L; **Example:** S2TD-10-L14A1A (add \$260.00 list)

Note: Leather arm caps available only when leather seat is specified. Arm cap will match seat.

Leather Seat and Back Jacket

To Specify, change the 6th digit to a 1; **Example:** S2TD-11-714A1A

Faux Leather Seat and Back Jacket

To Specify, change the 6th digit to a 3; **Example:** S2TD-33-714A1A

Stain Repellent

To specify, add P to end of the product number; **Example:** S2TD-20-714A1AP (add \$35.00 list)

Zody LX At-A-Glance

Designer	ITO Design and Haworth Design Studio
Awards/Achievements	<p>NeoCon Silver, Best of NeoCon, Seating: Ergonomic Desk/Task, June 2022, USA</p> <p>Metropolis Likes: Task Seating (winner) June 2022, USA</p> <p>Greenguard Gold</p> <p>Cradle to Cradle Certified Bronze</p>

Zody LX A high-performing chair that blends science-based wellness and comfort with sustainability and international design.

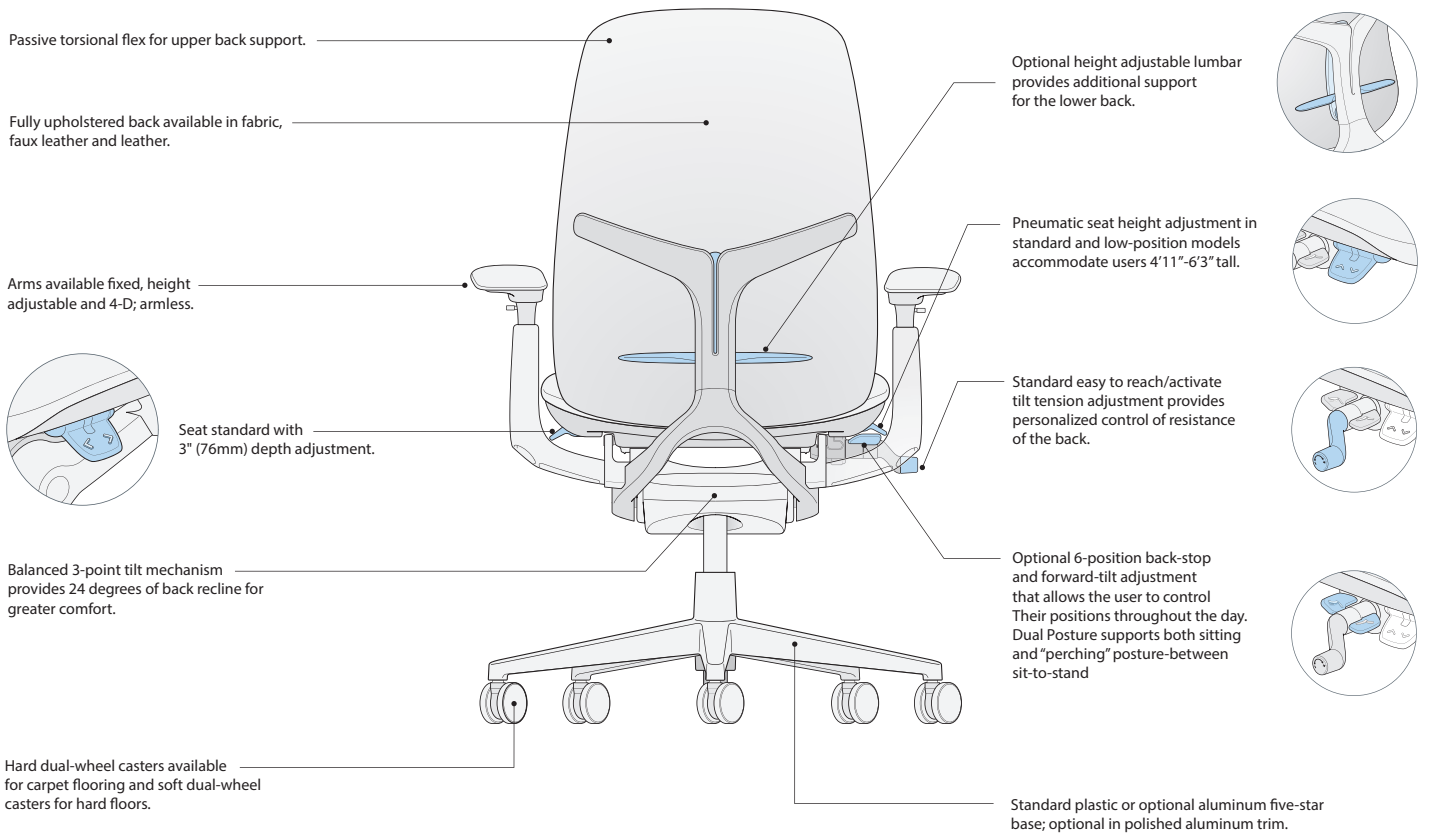

Note: Forward-tilt option not available on Stool.

Zody LX At-A-Glance

General Guidelines for Product Specification

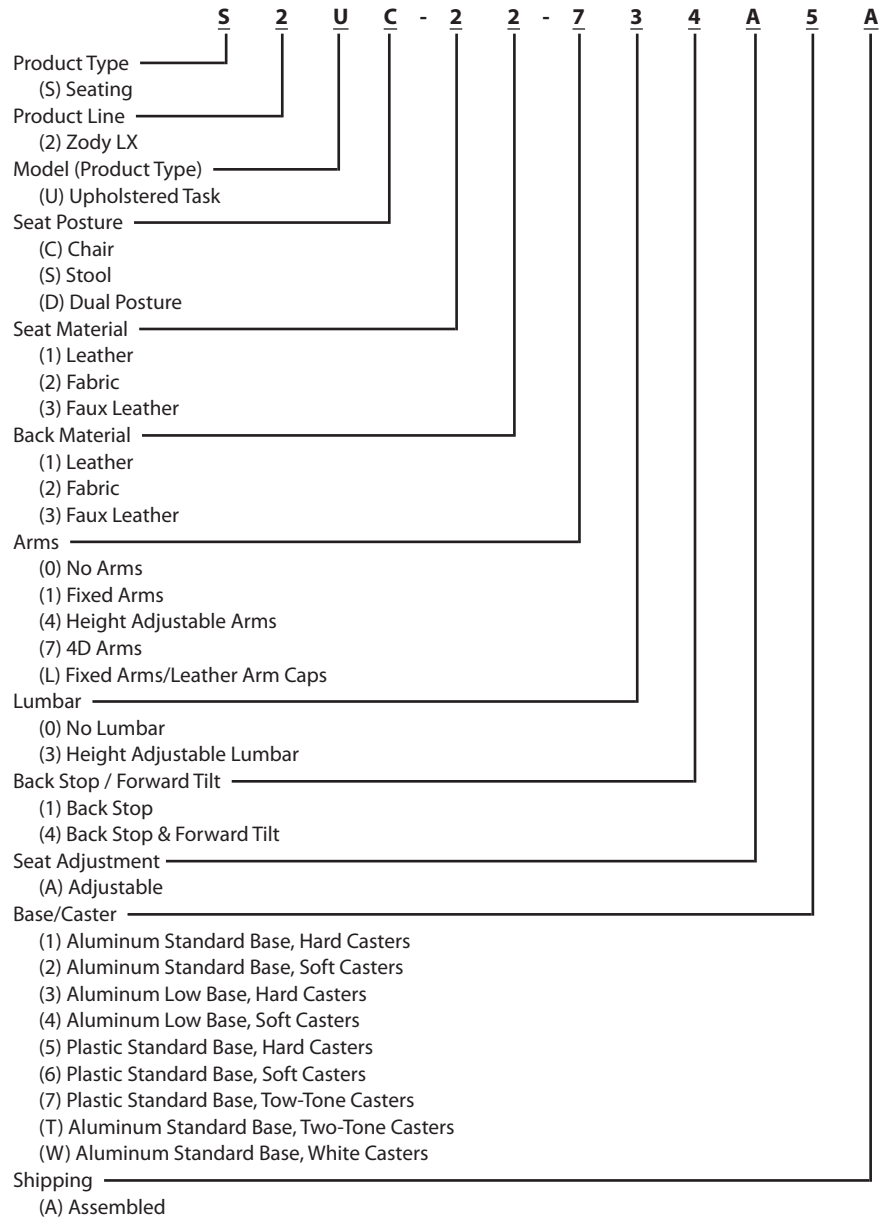

Zody LX At-A-Glance

General Specifications

Environmental Factors	<ul style="list-style-type: none">• Zody LX has been evaluated for its human health, environmental health, lifecycle attributes, renewable energy, water stewardship and social responsibility characteristics against stringent certification criteria and is considered an ecologically intelligent product.• Refer to Product Environmental Data sheet (PED) for recycled content and certifications.• Zody LX is produced in an ISO 14001 certified manufacturing facility.• Components are identified with ISO recycling symbols and material information to assist in the recycling effort, where practical.• Haworth will take back Zody LX chairs after their useful life and recycle the components. Please contact Haworth's Material Recovery Center at (616)393-1215.
COM & COL General Information	<p>To order a COM fabric (Customer's Own Material), contact the Haworth Inquiry Center (1.800.426.8562), your local Haworth dealer, or go to surfaces.haworth.com to find out if the COM you have selected has already been tested and approved. The surface collection site also has information on the Haworth alliance program with Carnegie, Luna Textiles, and Maharam as well as our industry-leading Pre-Approved COM program.</p> <p>COM fabrics are placed into Grades based on the cost per linear yard. If a fabric's cost exceeds the range of our highest Grade it will be noted as Non-Graded. The product will be priced at Grade A; the COM fabric costs will appear as a separate line item. The fabric charge will be Haworth's purchase cost plus a 4% administrative fee (based on the cost of the fabric). Yardage calculations will include any applicable fabric repeat.</p> <p>COM Leather products will be priced at a leather Grade A; COL costs will appear as a separate line item. The leather costs will be Haworth's purchase cost plus a 4% administrative fee (based on the cost of the leather).</p>
Finishes and Fabrics	For available finishes and fabrics please visit surfaces.haworth.com
Stain Repellent	<p>To specify add "P" to end of product number. Example: SZUC-22-731A5AP</p> <p>Not available on faux leather, or leather. For available fabrics, refer to surfaces.haworth.com.</p>
Shipping Weights (Including packaging)	<ul style="list-style-type: none">• Chairs with arms: 58 pounds/1 chair per carton/19.4 cubic feet• Chairs without arms: 52.6 pounds/1 chair per carton/19.4 cubic feet• Dual Posture with arms: 60.6 pounds/1 chair per carton/22.1 cubic feet• Dual Posture without arms: 55.2 pounds/1 chair per carton/22.1 cubic feet• Stool with arms: 61 pounds/1 stool per carton/22.1 cubic feet• Stool without arms: 55.6 pounds/1 stool per carton/22.1 cubic feet

Zody LX

General Specifications

STANDARD MOBILITY AND ADJUSTABILITY

Balanced 3-point tilt



Features:

- Balanced 3-point tilt mechanism.
- Back reclines 24° from the upright position.
- Seat pan moves downward 3° from the initial position.

Benefits:

- Comfortable relaxed posture.
- Recline allows for the opening of the users' chest cavity providing good airflow to promote alertness.
- Users' feet remain flat.

Tilt Tension Control

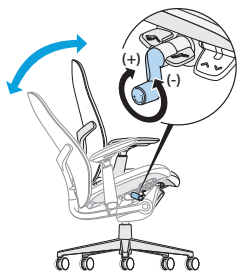

Feature:

- Easy-to-reach and easy-to-activate side-mounted tilt tension control regulates the amount of resistance felt when leaning back in the chair and the effort required to recline the chair backwards.

Benefit:

- Personalized support to accommodate users of different body types and different work styles.

Seat Height Adjustment

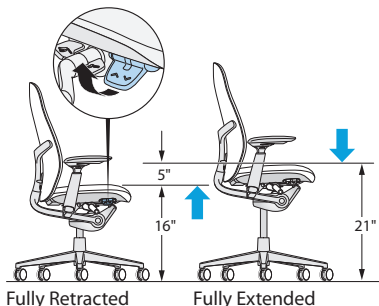

Features:

- Pneumatic seat height adjustment.
- Task chair seat height adjusts 5" (127mm) from 16" to 21" (406mm to 533mm) in standard models. Low-position adjusts 14.7" to 18" (373 to 457mm).
- Task stool seat height adjusts 7.3" (185mm) from 21" to 28.3" (533mm to 719mm).
- Dual Posture adjusts 17.5" to 24.2" (445mm to 615mm).

Benefits:

- Ensures the comfort of the lower limbs by avoiding pressure on the underside of the thigh caused by a seat pan that is too high, or decreased thigh-to-torso angle if the seat pan is too low.
- Accommodates for users between approximately 4'11" (1499mm) and 6'3" (1905mm) tall to provide good leg circulation.
- Seat height adjustment also is important in setting the proper hand position and allowing for a proper sitting eye height.

Seat Depth Adjustment

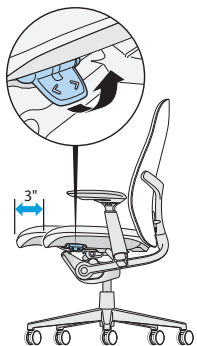

Features:

- 3" (76mm) of seat depth range.
- Waterfall edge.

Benefit:

- Supports the thighs, allows users to rest against the seat back for back support, and avoids pressure on the back of the knees of small to tall users.

Zody LX

General Specifications

OPTIONAL MOBILITY AND ADJUSTABILITY

Lumbar

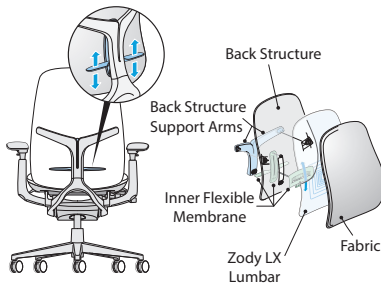

Features:

- Optional height adjustable lumbar.
- Range of 4”(102mm) of height adjustment.

Benefits:

- Lumbar adjustment maintains the natural curvature of the spine at the lower back and allows users to choose the support that feels right for them.

4D Arm

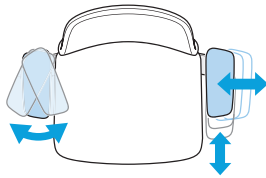

Features:

- Optional 4D arm.
- Arm adjusts in 4 ways:
 - Height adjustment: 4”(102mm)
 - Side-to-side arm cap adjustment range: 4”(102mm) [2”(51mm) each arm cap]
 - Front-to-back adjustment range: 2”(51mm)
 - Pivoting: In 20°; out 20°

Benefits:

- Arms support the muscular system of users’ neck and shoulders and proper arm support provides back relief. Arms can be an aid in standing or sitting down.
- Height adjustment accommodates for users with varying elbow rest heights so that users avoid lifting their shoulders or leaning sideways to get arm support.
- Front-to-back adjustment adjusts the armrest length, which is important because it allows users to get close to the worksurface while maintaining the effective use of the backrest.
- Side-to-side adjustment ensures a comfortable resting position for the arms with proper support of the forearm while allowing for easy entry/exit of the chair.
- Pivoting provides proper support of the forearm when performing tasks involving keying and mousing.

Adjustable Height Arm

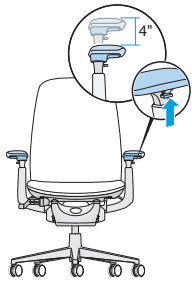

Feature:

- Optional height adjustable arms adjust 4”(102mm) vertically.

Benefit:

- Height adjustment accommodates users with varying elbow rest heights so that users avoid lifting their shoulders or leaning sideways to get arm support.

Back Stop

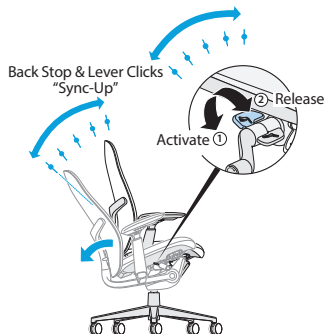

Features:

- Optional back stop;
- Back stops in 6 positions - upright and every 4° backward.

Benefit:

- Allows users the choice of selecting an upright position or limiting the amount of recline while performing different tasks.

Zody LX

General Specifications

OPTIONAL MOBILITY AND ADJUSTABILITY (continued)

Back Stop/Forward Tilt

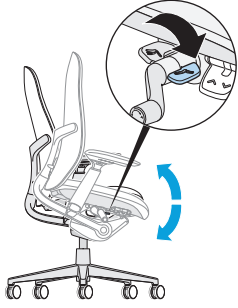
Feature:

- Optional back-stop and forward tilt.
- Back stops in 6 positions, upright and every 4° backward.
- Seat pan moves downward 5° from the initial position.

Benefits:

- Allows users to sit forward in the chair for task intensive work.
- Allows users to vary their posture for maximum comfort and for changes in task requirements.

Note: Not available on task stool.

Dual Posture

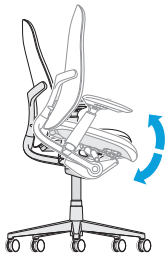
Features:

- Increased seat height range of 17.5"(445mm)-24.2"(615mm).
- Seat pan moves downward 5° from initial position with an increased degree of forward tilt.

Benefit:

- Promotes the in-between "perch" posture of sit-to-stand. Ideal for use with a height adjustable table.

Base

Standard Plastic Base

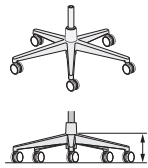

- TR-F Black
 TR-7 Fog

Note: When plastic base is specified all metal trim defaults to base color.

Hard casters in Black or Two-Tone Grey.
 Soft casters in Black.

Optional Aluminum Base

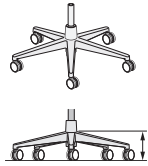

- TR-TF Pitch
 TR-LE Metallic Silver
 TR-MC Metallic Champagne
 TR-UFS Snowfall
 PM-P Polished Aluminum

Hard casters in Black, White or Two-Tone Grey.
 Soft casters in Black.

Low Position Base (Aluminum only)

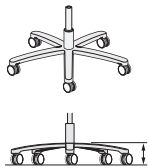

- TR-TF Pitch
 TR-LE Metallic Silver
 TR-MC Metallic Champagne
 TR-UFS Snowfall
 PM-P Polished Aluminum

Soft casters in Black.

Ergonomic Standards Guidelines

- All Zody LX models meet or exceed all ANSI/BIFMA durability standards for office seating.
- Zody LX meets the following ergonomic standards/guidelines:
 - BSR/HFES 100-2002
 - BIFMA G1-2002
 - CSA-Z412-2000
 - CAN/CGSB 44.232-2002
 - HFES 2007

Zody LX

Task Chair



S2UC-22-0



S2UC-22-1



S2UC-22-4



S2UC-22-7

Dimensions*

- *SH: 16"-21"(406mm-533mm)
(Std. base)
14.7"-18"(373mm-457mm)
(Low base)
- H: 38.8"-43.8"(986mm-1113mm)
(Std. base)
37.5"-40.8"(953mm-1036mm)
(Low base)
- D: 29"(737mm)
- W: 29"(737mm)
- *SW: 19.5"(495mm)
- *SD: 16.4"-19.4"(417mm-493mm)
- *AH: 7.6"-11.6"(193mm-295mm)
(Height Adjustable and 4D)
8.5"(216mm) (Fixed)

* Measurements taken with ISO chair measuring device.

Features

- Back: Fully upholstered.
- Seat: Upholstered with 3"(76mm) adjustable seat depth range.
- Base options:
 - Plastic standard five-star base.
Casters: Hard casters in black or two-tone grey; Soft casters black only.
 - Aluminum standard five-star base.
Casters: Hard casters in black, white or two-tone grey; Soft casters black only.
 - Aluminum low-position five-star base.
Casters: Hard or soft casters in black only.
- Arm options:
 - No arms
 - Fixed arms; Optional leather arm caps available when leather seat is specified. Leather arm caps will match seat.
 - Height Adjustable; 4"(102mm) height adjustment range.
 - 4D; 4"(102mm) height adjustment, 4"(102mm) side-to-side range, 2"(51mm) front-to-back range and pivots 20° in and 20° out.
- Arm Cap will match plastic trim color (Black or Fog). When Snow is specified, arm cap will default to Fog.
- Height adjustment: Pneumatic or low-position pneumatic.
- Back Stop: Tilt stop in 6 positions.
- Back Stop/Forward Tilt; Tilt stop in 6 positions plus forward tilt 5° downward from initial position.
- Lumbar adjustment options:
 - No Lumbar
 - Height Adjustable Lumbar: 4"(102mm) height adjustment.
- COM yardage / COL square footage:
Back: 0.80/12
Seat: 0.75/10

Upcharge for mixed grade surfaces, refer to the electronic design and specification tools.

To Order, Specify:

- 1) Product number, including:

1 Seat Material

- 1 Leather
- 2 Fabric
- 3 Faux Leather

2 Back Material

- 1 Leather
- 2 Fabric
- 3 Faux Leather

3 Base/Caster Option:

Plastic Base

- 5 Plastic Base, Hard Caster
- 6 Plastic Base, Soft Caster, add **\$52.08** list
- 7 Plastic Base, Two-Tone Grey Caster, add **\$20.00** list

Aluminum Base

- 1 Aluminum Base, Hard Caster, add **\$90.00** list
- 2 Aluminum Base, Soft Caster, add **\$142.08** list
- T Aluminum Base, Two-Tone Grey Caster, add **\$110.00** list
- W Aluminum Base, White Caster, add **\$110.00** list

Low Base - Aluminum

- 3 Aluminum Low Base, Hard Caster, add **\$90.00** list
- 4 Aluminum Low Base, Soft Caster, add **\$142.08** list

- 2) Seat upholstery.
- 3) Back upholstery.
- 4) Plastic trim color.¹
 - TR-F Black
 - TR-7 Fog, add **\$90.00** list
 - TR-UFM Snow,² add **\$150.00** list
- 5) Aluminum trim color.³
 - TR-TF Pitch
 - TR-LE Metallic Silver
 - TR-MC Metallic Champagne
 - TR-UFS Snowfall
 - PM-P Polished Aluminum
- 6) Base trim color.
 - Plastic
 - TR-F Black
 - TR-7 Fog, add **\$20.00** list
 - Aluminum
 - TR-TF Pitch
 - TR-LE Metallic Silver
 - TR-MC Metallic Champagne
 - TR-UFS Snowfall, add **\$20.00** list
 - PM-P Polished Aluminum, add **\$290.00** list

¹ Plastic trim color for Y-brace, arm caps, seat pan cover.

² When TR-UFM Snow trim is specified, arm cap and head rest will default to TR-7 Fog.

³ Aluminum trim color for back support, arm supports/uprights.

Zody LX

Task Chair

Plastic Base* Adjustments	Arm	Number ① ② ③	Fabric Grade								Leather Grade A	Leather Grade B
			A	B	C	D	E	F	G	H		
No Lumbar Adjustment												
Back Stop	No arm	S2UC-■■■-001A■A	\$1160.00	\$1234.14	\$1313.16	\$1352.73	\$1382.37	\$1454.06	\$1518.24	\$1693.69	\$2358.10	\$2759.08
	Fixed	S2UC-■■■-101A■A	1320.00	1394.14	1473.16	1512.73	1542.37	1614.06	1678.24	1853.69	2518.10	2919.08
	Height Adjustable	S2UC-■■■-401A■A	1360.00	1434.14	1513.16	1552.73	1582.37	1654.06	1718.24	1893.69	2558.10	2959.08
	4D	S2UC-■■■-701A■A	1394.00	1468.14	1547.16	1586.73	1616.37	1688.06	1752.24	1927.69	2592.10	2993.08
Back Stop/ Forward Tilt	No arm	S2UC-■■■-004A■A	1266.00	1340.14	1419.16	1458.73	1488.37	1560.06	1624.24	1799.69	2464.10	2865.08
	Fixed	S2UC-■■■-104A■A	1426.00	1500.14	1579.16	1618.73	1648.37	1720.06	1784.24	1959.69	2624.10	3025.08
	Height Adjustable	S2UC-■■■-404A■A	1466.00	1540.14	1619.16	1658.73	1688.37	1760.06	1824.24	1999.69	2664.10	3065.08
	4D	S2UC-■■■-704A■A	1500.00	1574.14	1653.16	1692.73	1722.37	1794.06	1858.24	2033.69	2698.10	3099.08
Height Adjustable Lumbar												
Back Stop	No arm	S2UC-■■■-031A■A	\$1257.00	\$1331.14	\$1410.16	\$1449.73	\$1479.37	\$1551.06	\$1615.24	\$1790.69	\$2455.10	\$2856.08
	Fixed	S2UC-■■■-131A■A	1417.00	1491.14	1570.16	1609.73	1639.37	1711.06	1775.24	1950.69	2615.10	3016.08
	Height Adjustable	S2UC-■■■-431A■A	1457.00	1531.14	1610.16	1649.73	1679.37	1751.06	1815.24	1990.69	2655.10	3056.08
	4D	S2UC-■■■-731A■A	1491.00	1565.14	1644.16	1683.73	1713.37	1785.06	1849.24	2024.69	2689.10	3090.08
Back Stop/ Forward Tilt	No arm	S2UC-■■■-034A■A	1363.00	1437.14	1516.16	1555.73	1585.37	1657.06	1721.24	1896.69	2561.10	2962.08
	Fixed	S2UC-■■■-134A■A	1523.00	1597.14	1676.16	1715.73	1745.37	1817.06	1881.24	2056.69	2721.10	3122.08
	Height Adjustable	S2UC-■■■-434A■A	1563.00	1637.14	1716.16	1755.73	1785.37	1857.06	1921.24	2096.69	2761.10	3162.08
	4D	S2UC-■■■-734A■A	1597.00	1671.14	1750.16	1789.73	1819.37	1891.06	1955.24	2130.69	2795.10	3196.08

* Pricing based on Plastic base with hard casters.

The following options require modification of the product number.

Leather Arm Caps (Fixed arm only)

To specify, change the 7th digit to an L; **Example:** S2UC-11-L04A5A (add \$260.00 list)

Note: Leather arm caps available only when leather seat is specified. Arm cap will match seat.

Stain Repellent

To specify, add P to end of the product number; **Example:** S2UC-22-731A5AP (add \$35.00 list)

Zody LX

Stool



S2US-22-0



S2US-22-1



S2US-22-4



S2US-22-7

Dimensions*

- *SH: 21"-28.3"(533mm-719mm)
- H: 43.8"-51.1"(1113mm-1298mm)
- D: 29"(737mm)
- W: 29"(737mm)
- *SW: 19.5"(495mm)
- *SD: 16.4"-19.4"(417mm-493mm)
- *AH: 7.6"-11.6"(193mm-295mm)
(Height Adjustable and 4D)
8.5"(216mm) (Fixed)

* Measurements taken with ISO chair measuring device.

Features

- Back: Fully upholstered.
- Seat: Upholstered with 3"(76mm) adjustable seat depth range.
- Base options:
 - Plastic standard five-star base.
Casters: Hard casters in black or two-tone grey; Soft casters black only.
 - Aluminum standard five-star base.
Casters: Hard casters in black, white or two-tone grey; Soft casters black only.
- Arm options:
 - No arms
 - Fixed arms; Optional leather arm caps available when leather seat is specified. Leather arm caps will match seat.
 - Height Adjustable; 4"(102mm) height adjustment range.
 - 4D; 4"(102mm) height adjustment, 4"(102mm) side-to-side range, 2"(51mm) front-to-back range and pivots 20° in and 20° out.
- Arm Cap will match plastic trim color (Black or Fog). When Snow is specified, arm cap will default to Fog.
- Height adjustment: Pneumatic.
- Back Stop: Tilt stop in 6 positions.
- Lumbar adjustment options:
 - No Lumbar
 - Height Adjustable Lumbar: 4"(102mm) height adjustment.
- COM yardage / COL square footage:
Back: 0.80/12
Seat: 0.75/10

Upcharge for mixed grade surfaces, refer to the electronic design and specification tools.

To Order, Specify:

1) Product number, including:

1 Seat Material

- 1 Leather
- 2 Fabric
- 3 Faux Leather

2 Back Material

- 1 Leather
- 2 Fabric
- 3 Faux Leather

3 Base/Caster Option:

Plastic Base

- 5 Plastic Base, Hard Caster
- 6 Plastic Base, Soft Caster, add **\$52.08** list
- 7 Plastic Base, Two-Tone Grey Caster, add **\$20.00** list

Aluminum Base

- 1 Aluminum Base, Hard Caster, add **\$90.00** list
- 2 Aluminum Base, Soft Caster, add **\$142.08** list
- T Aluminum Base, Two-Tone Grey Caster, add **\$110.00** list
- W Aluminum Base, White Caster, add **\$110.00** list

- 2) Seat upholstery.
- 3) Back upholstery.
- 4) Plastic trim color.¹
 - TR-F Black
 - TR-7 Fog, add **\$90.00** list
 - TR-UFM Snow,² add **\$142.08** list
- 5) Aluminum trim color.³
 - TR-TF Pitch
 - TR-LE Metallic Silver
 - TR-MC Metallic Champagne
 - TR-UFS Snowfall
 - PM-P Polished Aluminum
- 6) Base trim color.
 - Plastic
 - TR-F Black
 - TR-7 Fog, add **\$20.00** list
 - Aluminum
 - TR-TF Pitch
 - TR-LE Metallic Silver
 - TR-MC Metallic Champagne
 - TR-UFS Snowfall, add **\$20.00** list
 - PM-P Polished Aluminum, add **\$290.00** list

¹ Plastic trim color for Y-brace, arm caps, seat pan cover.

² When TR-UFM Snow trim is specified, arm cap will default to TR-7 Fog.

³ Aluminum trim color for back support, arm supports/uprights.

Zody LX

Stool

Plastic Base* Adjustments	Arm	Number			Fabric Grade								Leather Grade A	Leather Grade B	
		①	②	③	A	B	C	D	E	F	G	H			
No Lumbar Adjustment															
Back Stop	No arm	S2US-		-001A	A	\$1417.00	\$1491.14	\$1570.16	\$1609.73	\$1639.37	\$1711.06	\$1775.24	\$1950.69	\$2615.10	\$3016.08
	Fixed	S2US-		-101A	A	1577.00	1651.14	1730.16	1769.73	1799.37	1871.06	1935.24	2110.69	2775.10	3176.08
	Height Adjustable	S2US-		-401A	A	1617.00	1691.14	1770.16	1809.73	1839.37	1911.06	1975.24	2150.69	2815.10	3216.08
	4D	S2US-		-701A	A	1651.00	1725.14	1804.16	1843.73	1873.37	1945.06	2009.24	2184.69	2849.10	3250.08
Height Adjustable Lumbar															
Back Stop	No arm	S2US-		-031A	A	\$1514.00	\$1588.14	\$1667.16	\$1706.73	\$1736.37	\$1808.06	\$1872.24	\$2047.69	\$2712.10	\$3113.08
	Fixed	S2US-		-131A	A	1674.00	1748.14	1827.16	1866.73	1896.37	1968.06	2032.24	2207.69	2872.10	3273.08
	Height Adjustable	S2US-		-431A	A	1714.00	1788.14	1867.16	1906.73	1936.37	2008.06	2072.24	2247.69	2912.10	3313.08
	4D	S2US-		-731A	A	1748.00	1822.14	1901.16	1940.73	1970.37	2042.06	2106.24	2281.69	2946.10	3347.08

* Pricing based on Plastic base with hard casters.

The following options require modification of the product number.

Leather Arm Caps (Fixed arm only)

To specify, change the 7th digit to an **L**; **Example:** S2US-11-L31A5A (add **\$260.00** list)

Note: Leather arm caps available only when leather seat is specified. Arm cap will match seat.

Stain Repellent

To specify, add **P** to end of the product number; **Example:** S2US-22-701A5AP (add **\$35.00** list)

Zody LX

Dual Posture



S2UD-22-1



S2UD-22-4



S2UD-22-7

Dimensions*

- *SH: 17.5"-24.2"(445mm-615mm)
- H: 40.3"-47"(1024mm-1194mm)
- D: 29"(737mm)
- W: 29"(737mm)
- *SW: 19.5"(495mm)
- *SD: 16.4"-19.4"(417mm-493mm)
- *AH: 7.6"-11.6"(193mm-295mm)
(Height Adjustable and 4D)
8.5"(216mm) (Fixed)

* Measurements taken with ISO chair measuring device.

Features

- Back: Fully upholstered.
- Seat: Upholstered with 3"(76mm) adjustable seat depth range.
- Base options:
 - Aluminum standard five-star base.
 - Casters: Hard casters in black, white or two-tone grey; Soft casters black only.
- Arm options:
 - Fixed arms; Optional leather arm caps available when leather seat is specified. Leather arm caps will match seat.
 - Height Adjustable; 4"(102mm) height adjustment range.
 - 4D; 4"(102mm) height adjustment, 4"(102mm) side-to-side range, 2"(51mm) front-to-back range and pivots 20° in and 20° out.
- Arm Cap will match plastic trim color (Black or Fog). When Snow is specified, arm cap will default to Fog.
- Height adjustment: Pneumatic.
- Back Stop/Forward Tilt; Tilt stop in 6 positions plus forward tilt 5° downward from initial position.
- Lumbar adjustment options:
 - No Lumbar
 - Height Adjustable Lumbar: 4"(102mm) height adjustment.
- COM yardage / COL square footage:
 - Back: 0.80/12
 - Seat: 0.75/10

Upcharge for mixed grade surfaces, refer to the electronic design and specification tools.

To Order, Specify:

1) Product number, including:

1 Seat Material

- 1 Leather
- 2 Fabric
- 3 Faux Leather

2 Back Material

- 1 Leather
- 2 Fabric
- 3 Faux Leather

3 Base/Caster Option:

Aluminum Base

- 1 Aluminum Base, Hard Caster
- 2 Aluminum Base, Soft Caster, add **\$52.08** list
- T Aluminum Base, Two-Tone Grey Caster, add **\$20.00** list
- W Aluminum Base, White Caster, add **\$20.00** list

- 2) Seat upholstery.
- 3) Back upholstery.
- 4) Plastic trim color.¹
 - TR-F Black
 - TR-7 Fog, add **\$90.00** list
 - TR-UFM Snow,² add **\$150.00** list
- 5) Aluminum trim color.³
 - TR-TF Pitch
 - TR-LE Metallic Silver
 - TR-MC Metallic Champagne
 - TR-UFS Snowfall
 - PM-P Polished Aluminum
- 6) Base trim color.
 - TR-TF Pitch
 - TR-LE Metallic Silver
 - TR-MC Metallic Champagne
 - TR-UFS Snowfall, add **\$20.00** list
 - PM-P Polished Aluminum, add **\$290.00** list

¹ Plastic trim color for Y-brace, arm caps, seat pan cover.

² When TR-UFM Snow trim is specified, arm cap will default to TR-7 Fog.

³ Aluminum trim color for back support, arm supports/uprights.

Zody LX

Dual Posture

Adjustments	Arm	Number			Fabric Grade								Leather Grade A	Leather Grade B	
		1	2	3	A	B	C	D	E	F	G	H			
No Lumbar Adjustment															
Back Stop/ Forward Tilt	Fixed	S2UD-		-104A	A	\$1716.00	\$1790.14	\$1869.16	\$1908.73	\$1938.37	\$2010.06	\$2074.24	\$2249.69	\$2914.10	\$3315.08
	Height Adjustable	S2UD-		-404A	A	1756.00	1830.14	1909.16	1948.73	1978.37	2050.06	2114.24	2289.69	2954.10	3355.08
	4D	S2UD-		-704A	A	1790.00	1864.14	1943.16	1982.73	2012.37	2084.06	2148.24	2323.69	2988.10	3389.08
Height Adjustable Lumbar Adjustment															
Back Stop/ Forward Tilt	Fixed	S2UD-		-134A	A	\$1813.00	\$1887.14	\$1966.16	\$2005.73	\$2035.37	\$2107.06	\$2171.24	\$2346.69	\$3011.10	\$3412.08
	Height Adjustable	S2UD-		-434A	A	1853.00	1927.14	2006.16	2045.73	2075.37	2147.06	2211.24	2386.69	3051.10	3452.08
	4D	S2UD-		-734A	A	1887.00	1961.14	2040.16	2079.73	2109.37	2181.06	2245.24	2420.69	3085.10	3486.08

The following options require modification of the product number.

Leather Arm Caps (Fixed arm only)

To specify, change the 7th digit to an L; **Example:** S2UD-11-L04A1A (add **\$260.00** list)

Note: Leather arm caps available only when leather seat is specified. Arm cap will match seat.

Stain Repellent

To specify, add P to end of the product number; **Example:** S2UD-22-704A1AP (add **\$35.00** list)